

Machine Automation Controller Industrial PC Platform

NJ/NY-series

G code Instructions Reference Manual

NJ501-5300

NY532-5400

NOTE

All rights reserved. No part of this publication may be reproduced, stored in a retrieval system, or transmitted, in any form, or by any means, mechanical, electronic, photocopying, recording, or otherwise, without the prior written permission of OMRON.

No patent liability is assumed with respect to the use of the information contained herein. Moreover, because OMRON is constantly striving to improve its high-quality products, the information contained in this manual is subject to change without notice. Every precaution has been taken in the preparation of this manual. Nevertheless, OMRON assumes no responsibility for errors or omissions. Neither is any liability assumed for damages resulting from the use of the information contained in this publication.

Trademarks

- Sysmac and SYSMAC are trademarks or registered trademarks of OMRON Corporation in Japan and other countries for OMRON factory automation products.
- Microsoft, Windows, Excel, and Visual Basic are either registered trademarks or trademarks of Microsoft Corporation in the United States and other countries.
- EtherCAT® is registered trademark and patented technology, licensed by Beckhoff Automation GmbH, Germany.
- ODVA, CIP, CompoNet, DeviceNet, and EtherNet/IP are trademarks of ODVA.
- The SD and SDHC logos are trademarks of SD-3C, LLC.  
- Intel and Intel Core are trademarks of Intel Corporation in the U.S. and / or other countries.

Other company names and product names in this document are the trademarks or registered trademarks of their respective companies.

Copyrights

Microsoft product screen shots reprinted with permission from Microsoft Corporation.

Introduction

Thank you for purchasing an NJ/NY-series NC Integrated Controller. (“NJ/NY-series NC Integrated Controller” is sometimes abbreviated as “NC Integrated Controller”.)

This manual contains information that is necessary to use the NC Integrated Controller. Please read this manual and make sure you understand the functionality and performance of the NC Integrated Controller before you attempt to use it in a control system.

Keep this manual in a safe place where it will be available for reference during operation.

This manual only describes functions that are added to NJ501-5300 or NY532-5400.

When you use NJ501-5300, also consult manuals for the NJ-series listed in *Related Manuals* on page 21 for functions common to NJ501-□□□□ Series including NJ501-1□□□.

When you use NY532-5400, also consult manuals for the NY-series listed in *Related Manuals* on page 21 for functions common to NY532-□□□□ Series including NY532-1□□□.

Intended Audience

This manual is intended for the following personnel, who must also have knowledge of electrical systems (an electrical engineer or person with equivalent skills).

- Personnel in charge of introducing FA systems
- Personnel in charge of designing FA systems
- Personnel in charge of installing and maintaining FA systems
- Personnel in charge of managing FA systems and facilities

This manual is also intended for personnel who understand the following contents.

- For programming, this manual is intended for personnel who understand the programming language specifications in international standard IEC 61131-3 or Japanese standard JIS 3503.
- For NC programming, this manual is intended for personnel who understand the programming language specifications in international standard ISO 6983-1 or Japanese standard JIS 6315.

Applicable Products

This manual covers the following products.

- NJ-series NC Integrated Controller
NJ501-5300
- NY-series NC Integrated Controller
NY532-5400

Relevant Manuals

The following table lists the relevant manuals for this product. Read all of the manuals that are relevant to your system configuration and application before you use this product.

Most operations are performed from the Sysmac Studio and CNC Operator Automation Software.

Refer to the *Sysmac Studio Version 1 Operation Manual* (Cat. No. W504) for information on the Sysmac Studio, and *CNC Operator Operation Manual* (Cat. No. O032) for the CNC Operator.

Relevant Manuals for NJ Series

Purpose of use	Manual									
	Basic information			NJ/NX-series CPU Unit Motion Control User's Manual	NJ/NX-series Motion Control Instructions Reference Manual	NJ/NX-series CPU Unit Built-in EtherCAT® Port User's Manual	NJ/NX-series CPU Unit Built-in EtherNet/IP™ Port User's Manual	NJ/NY-series NC Integrated Controller User's Manual	NJ/NY-series G code Instructions Reference Manual	NJ/NX-series Troubleshooting Manual
	NJ-series CPU Unit Hardware User's Manual	NJ/NX-series CPU Unit Software User's Manual	NJ/NX-series Instructions Reference Manual							
Introduction to NJ-series Controllers	●									
Setting devices and hardware	●			●		●				
Using motion control										
Using EtherCAT										
Using EtherNet/IP							●			
Software settings										
Using motion control				●						
Using EtherCAT		●				●				
Using EtherNet/IP							●			
Using numerical control								●		
Writing the user program										
Using motion control				●	●					
Using EtherCAT		●	●			●				
Using EtherNet/IP							●			
Using numerical control								●	●	
Programming error processing										●
Testing operation and debugging										
Using motion control				●						
Using EtherCAT		●				●				
Using EtherNet/IP							●			
Using numerical control								●		

Purpose of use	Manual								
	Basic information		N/J/NX-series CPU Unit Motion Control User's Manual	N/J/NX-series Motion Control Instructions Reference Manual	N/J/NX-series CPU Unit Built-in EtherCAT® Port User's Manual	N/J/NX-series CPU Unit Built-in EtherNet/IP™ Port User's Manual	N/J/NY-series NC Integrated Controller User's Manual	N/J/NY-series G code Instructions Reference Manual	N/J/NX-series Troubleshooting Manual
	N/J-series CPU Unit Hardware User's Manual	N/J/NX-series CPU Unit Software User's Manual							
Learning about error management and corrections *1						△		●	
Maintenance	●		●						
Using motion control				●					
Using EtherCAT					●				
Using EtherNet/IP					●				

*1. Refer to the NJ/NX-series Troubleshooting Manual (Cat. No. W503) for the error management concepts and the error items. However, refer to the manuals that are indicated with triangles (△) for details on errors corresponding to the products with the manuals that are indicated with triangles (△).

Relevant Manuals for NY Series

Purpose of use	Manual										
	Basic information										
	NY-series Industrial Panel PC Hardware User's Manual	NY-series Industrial Box PC Hardware User's Manual	NY-series Industrial Panel PC / Industrial Box PC Setup User's Manual	NY-series Industrial Panel PC / Industrial Box PC Software User's Manual	NY-series Industrial Panel PC / Industrial Box PC Motion Control User's Manual	NY-series Motion Control Instructions Reference Manual	NY-series Industrial Panel PC / Industrial Box PC Built-in EtherCAT Port User's Manual	NY-series Industrial Panel PC / Industrial Box PC Built-in EtherNet/IP Port User's Manual	NJ/NY-series NC Integrated Controller User's Manual	NJ/NY-series G code Instructions Reference Manual	NY-series Troubleshooting Manual
Introduction to NY-series Panel PCs	○										
Introduction to NY-series Box PCs		○									
Setting devices and hardware	○										
Using motion control		○			○						
Using EtherCAT						○					
Using EtherNet/IP							○				
Making setup ^{*1}											
Making initial settings			○								
Preparing to use Controllers											
Software settings											
Using motion control					○						
Using EtherCAT				○			○				
Using EtherNet/IP								○			
Using numerical control									○		
Writing the user program											
Using motion control						○	○				
Using EtherCAT				○	○			○			
Using EtherNet/IP									○	○	
Using CNC functions											○
Programming error processing											
Testing operation and debugging											
Using motion control					○						
Using EtherCAT				○			○				
Using EtherNet/IP								○			
Using numerical control									○		
Learning about error management and corrections ^{*2}									△		○
Maintenance											
Using motion control	○	○				○					
Using EtherCAT							○				
Using EtherNet/IP								○			

*1. Refer to the *NY-series Industrial Panel PC / Industrial Box PC Setup User's Manual* (Cat. No. W568) for how to set up and how to use the utilities on Windows.

*2. Refer to the *NY-series Troubleshooting Manual* (Cat. No. W564) for the error management concepts and the error items. However, refer to the manuals that are indicated with triangles (△) for details on errors corresponding to the products with the manuals that are indicated with triangles (△).

Manual Structure

Page Structure and Symbols

The following page structure and symbols are used in this manual.

The diagram illustrates a page from a manual with the following structure and annotations:

- Level 1 heading:** 4 Installation and Wiring
- Level 2 heading:** 4-3 Mounting Units
- Level 3 heading:** 4-3-1 Connecting Controller Components
- Text:** The Units that make up an NJ-series Controller can be connected simply by pressing the Units together and locking the sliders by moving them toward the back of the Units. The End Cover is connected in the same way to the Unit on the far right side of the Controller.
- Step 1:** 1 Join the Units so that the connectors fit exactly.
 - Diagram:** Shows units with labels for Hook, Connector, and Hook holes.
- Step 2:** 2 The yellow sliders at the top and bottom of each Unit lock the Units together. Move the sliders toward the back of the Units as shown below until they click into place.
 - Diagram:** Shows units with sliders. A callout shows a slider moving from 'Release' to 'Lock' position.
- Section Header:** **Precautions for Correct Use** (indicated by a warning icon)
- Text:** The sliders on the tops and bottoms of the Power Supply Unit, CPU Unit, I/O Units, Special I/O Units, and CPU Bus Units must be completely locked (until they click into place) after connecting the adjacent Unit connectors.
- Page Tab:** 4
- Manual Name:** NJ-series CPU Unit Hardware User's Manual (W500)
- Page Number:** 4-9

Note This illustration is only provided as a sample. It may not literally appear in this manual.

Special Information

Special information in this manual is classified as follows:



Precautions for Safe Use

Precautions on what to do and what not to do to ensure safe usage of the product.



Precautions for Correct Use

Precautions on what to do and what not to do to ensure proper operation and performance.



Additional Information

Additional information to read as required.

This information is provided to increase understanding and ease of operation.



Version Information

Information on differences in specifications and functionality for NC Integrated Controller with different unit versions and for different versions of the Sysmac Studio and the CNC Operator are given.

Note References are provided to more detailed or related information.

Sections in this Manual

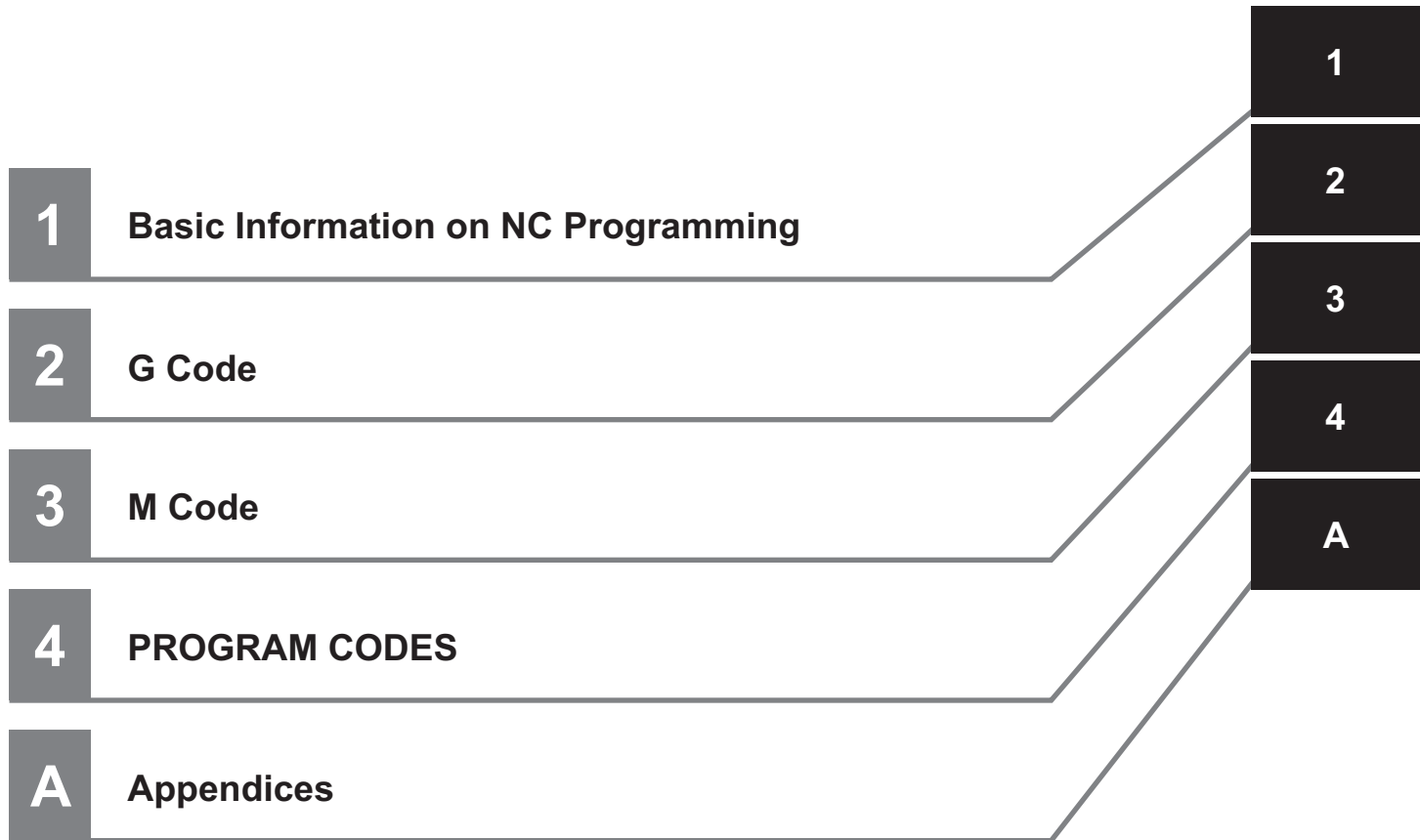

CONTENTS

Introduction	1
Intended Audience	1
Applicable Products	1
Relevant Manuals	2
Relevant Manuals for NJ Series	2
Relevant Manuals for NY Series	4
Manual Structure	5
Page Structure and Symbols	5
Special Information	6
Sections in this Manual	7
Terms and Conditions Agreement	12
Warranty, Limitations of Liability	12
Application Considerations	13
Disclaimers	13
Safety Precautions	14
Precautions for Safe Use	15
Precaution for Correct Use	16
Regulations and Standards	17
Versions	18
Checking Versions	18
Related Manuals	21
Terminology	24
Revision History	25

Section 1 Basic Information on NC Programming

Instructions	1-2
Instruction Parameters	1-5
G Code Descriptions	1-7
What is Modal?	1-9

Section 2 G Code

Interpolation Functions	2-3
G00 Rapid Positioning	2-4
G01 Linear Interpolation	2-6
G02, G03 Circular Interpolation	2-8
G31 Skip Function	2-13
Dwell	2-15
G04 Dwell	2-16
Feed Functions	2-17
Feedrate Function (F function)	2-18

Acceleration Time, Deceleration Time, Jerk Time	2-19
G09 Exact Stop	2-20
G61 Exact Stop Mode	2-21
G64 Continuous-path Mode	2-22
G500, G501 Multi-block Acceleration/Deceleration Rate	2-24
Coordinate System	2-27
G52 Local Coordinate System Set	2-28
G53 Dimension Shift Cancel	2-29
G54 to G59 Select Work Coordinate System	2-30
G17, G18, G19 Plane Selection	2-31
G20 Inch Input, G21 Metric Input	2-32
G90 Absolute Dimension, G91 Incremental Dimension	2-33
Reference Point	2-35
G28 Return to Reference Point	2-36
G30 Return to 2nd, 3rd and 4th Reference Point	2-38
Compensation Functions	2-39
G40, G41, G42 Cutter Compensation	2-40
G43, G44, G49 Tool Offset	2-51
G50, G51 Scaling	2-53
G50.1, G51.1 Mirroring	2-55
G68, G69 Coordinate System Rotation	2-57
Utilities	2-59
G74 Left-handed Tapping Cycle	2-60
G80 Fixed Cycle Cancel	2-62
G84 Tapping Cycle	2-63
G98 Fixed Cycle Return to Initial Level	2-66
G99 Fixed Cycle Return to R Point Level	2-67
Chamfer and Fillet Functions	2-68

Section 3 M Code

Auxiliary Function Output	3-3
M Code Descriptions	3-5
Reservation Auxiliary Functions	3-7
M00 Program Stop	3-8
M01 Optional Stop	3-9
M02, M30 End of Program	3-10
Spindle Axis	3-11
Spindle Axis Rotation Function (S function)	3-12
M03 Spindle CW	3-13
M04 Spindle CCW	3-14
M05 Spindle OFF	3-15
M19 Spindle Orientation	3-16
Programming	3-19
M98 Subprogram Call	3-20
M99 Subprogram End	3-21

Section 4 PROGRAM CODES

4-1 Calculation and Logic Operation	4-2
4-1-1 Operator priority	4-2
4-1-2 Arithmetic operators	4-2
4-1-3 Functions	4-3
4-1-4 Condition comparators	4-5
4-1-5 Conditional join operators	4-5
4-2 Branch and Repetition	4-6
4-2-1 if/else	4-6
4-2-2 switch/case	4-6

4-2-3	while	4-6
4-2-4	do/while	4-6
4-3	User Variables	4-7
4-3-1	Local Variables ("L")	4-7
4-3-2	Coordinate System Global Variables ("Q")	4-7
4-3-3	Global Variables ("P")	4-7
4-3-4	Variable Indirection	4-7

Appendices

A-1	Program Parsing by CNC Operator	A-2
A-1-1	Intermediate code format	A-2
A-1-2	Program Parsing Example	A-4

Terms and Conditions Agreement

Warranty, Limitations of Liability

Warranties

● Exclusive Warranty

Omron's exclusive warranty is that the Products will be free from defects in materials and workmanship for a period of twelve months from the date of sale by Omron (or such other period expressed in writing by Omron). Omron disclaims all other warranties, express or implied.

● Limitations

OMRON MAKES NO WARRANTY OR REPRESENTATION, EXPRESS OR IMPLIED, ABOUT NON-INFRINGEMENT, MERCHANTABILITY OR FITNESS FOR A PARTICULAR PURPOSE OF THE PRODUCTS. BUYER ACKNOWLEDGES THAT IT ALONE HAS DETERMINED THAT THE PRODUCTS WILL SUITABLY MEET THE REQUIREMENTS OF THEIR INTENDED USE.

Omron further disclaims all warranties and responsibility of any type for claims or expenses based on infringement by the Products or otherwise of any intellectual property right.

● Buyer Remedy

Omron's sole obligation hereunder shall be, at Omron's election, to (i) replace (in the form originally shipped with Buyer responsible for labor charges for removal or replacement thereof) the non-complying Product, (ii) repair the non-complying Product, or (iii) repay or credit Buyer an amount equal to the purchase price of the non-complying Product; provided that in no event shall Omron be responsible for warranty, repair, indemnity or any other claims or expenses regarding the Products unless Omron's analysis confirms that the Products were properly handled, stored, installed and maintained and not subject to contamination, abuse, misuse or inappropriate modification. Return of any Products by Buyer must be approved in writing by Omron before shipment. Omron Companies shall not be liable for the suitability or unsuitability or the results from the use of Products in combination with any electrical or electronic components, circuits, system assemblies or any other materials or substances or environments. Any advice, recommendations or information given orally or in writing, are not to be construed as an amendment or addition to the above warranty.

See <http://www.omron.com/global/> or contact your Omron representative for published information.

Limitation on Liability; Etc

OMRON COMPANIES SHALL NOT BE LIABLE FOR SPECIAL, INDIRECT, INCIDENTAL, OR CONSEQUENTIAL DAMAGES, LOSS OF PROFITS OR PRODUCTION OR COMMERCIAL LOSS IN ANY WAY CONNECTED WITH THE PRODUCTS, WHETHER SUCH CLAIM IS BASED IN CONTRACT, WARRANTY, NEGLIGENCE OR STRICT LIABILITY.

Further, in no event shall liability of Omron Companies exceed the individual price of the Product on which liability is asserted.

Application Considerations

Suitability of Use

Omron Companies shall not be responsible for conformity with any standards, codes or regulations which apply to the combination of the Product in the Buyer's application or use of the Product. At Buyer's request, Omron will provide applicable third party certification documents identifying ratings and limitations of use which apply to the Product. This information by itself is not sufficient for a complete determination of the suitability of the Product in combination with the end product, machine, system, or other application or use. Buyer shall be solely responsible for determining appropriateness of the particular Product with respect to Buyer's application, product or system. Buyer shall take application responsibility in all cases.

NEVER USE THE PRODUCT FOR AN APPLICATION INVOLVING SERIOUS RISK TO LIFE OR PROPERTY OR IN LARGE QUANTITIES WITHOUT ENSURING THAT THE SYSTEM AS A WHOLE HAS BEEN DESIGNED TO ADDRESS THE RISKS, AND THAT THE OMRON PRODUCT(S) IS PROPERLY RATED AND INSTALLED FOR THE INTENDED USE WITHIN THE OVERALL EQUIPMENT OR SYSTEM.

Programmable Products

Omron Companies shall not be responsible for the user's programming of a programmable Product, or any consequence thereof.

Disclaimers

Performance Data

Data presented in Omron Company websites, catalogs and other materials is provided as a guide for the user in determining suitability and does not constitute a warranty. It may represent the result of Omron's test conditions, and the user must correlate it to actual application requirements. Actual performance is subject to the Omron's Warranty and Limitations of Liability.

Change in Specifications

Product specifications and accessories may be changed at any time based on improvements and other reasons. It is our practice to change part numbers when published ratings or features are changed, or when significant construction changes are made. However, some specifications of the Product may be changed without any notice. When in doubt, special part numbers may be assigned to fix or establish key specifications for your application. Please consult with your Omron's representative at any time to confirm actual specifications of purchased Product.

Errors and Omissions

Information presented by Omron Companies has been checked and is believed to be accurate; however, no responsibility is assumed for clerical, typographical or proofreading errors or omissions.

Safety Precautions

Refer to the following manuals for safety precautions.

- *NJ-series CPU Unit Hardware User's Manual* (Cat. No. W500)
- *NY-series Industrial Panel PC Hardware User's Manual* (Cat. No. W557)
- *NJ/NY-series NC Integrated Controller User's Manual* (Cat. No. O030)
- *CNC Operator Operation Manual* (Cat. No. O032)

Precautions for Safe Use

Refer to the following manuals for precautions for safe use.

- *NJ-series CPU Unit Hardware User's Manual* (Cat. No. W500)
- *NY-series Industrial Panel PC Hardware User's Manual* (Cat. No. W557)
- *NJ/NY-series NC Integrated Controller User's Manual* (Cat. No. O030)
- *CNC Operator Operation Manual* (Cat. No. O032)

Precaution for Correct Use

Refer to the following manuals for precautions for correct use.

- *NJ-series CPU Unit Hardware User's Manual* (Cat. No. W500)
- *NY-series Industrial Panel PC Hardware User's Manual* (Cat. No. W557)
- *NJ/NY-series NC Integrated Controller User's Manual* (Cat. No. O030)
- *CNC Operator Operation Manual* (Cat. No. O032)

Regulations and Standards

Refer to the following manuals for regulations and standards.

- *NJ-series CPU Unit Hardware User's Manual* (Cat. No. W500)
- *NY-series Industrial Panel PC Hardware User's Manual* (Cat. No. W557)

Versions

Hardware revisions and unit versions are used to manage the hardware and software in NJ/NY-series Units and EtherCAT slaves. The hardware revision or unit version is updated each time there is a change in hardware or software specifications. Even when two Units or EtherCAT slaves have the same model number, they will have functional or performance differences if they have different hardware revisions or unit versions.

Checking Versions

You can check versions on the ID information indications or with the Sysmac Studio.

Checking Unit Versions on ID Information Indications

The unit version is given on the ID information indication on the side of the product.

- **Checking the Unit Version of an NJ-series CPU Unit**

The ID information on the NJ501-5300 is shown below.

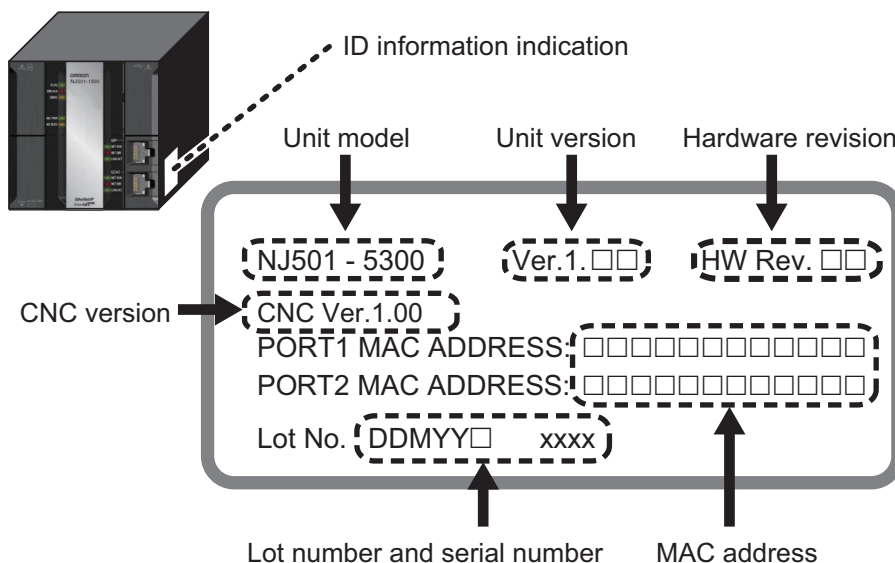

- **Checking the Unit Version of an NY-series Controller**

The ID information on an NY-series NY5□2-1□□□ Controller is shown below.

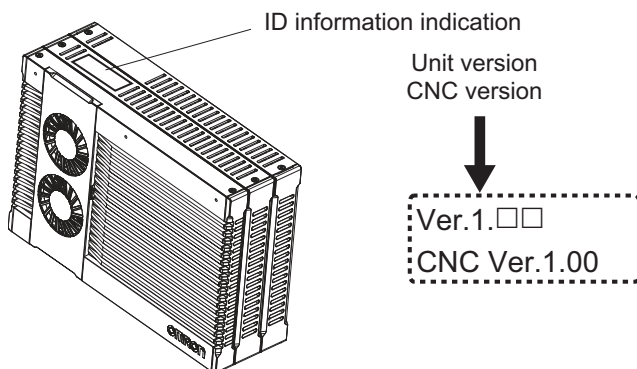

Checking Unit Versions with the Sysmac Studio

You can use the Sysmac Studio to check unit versions. The procedure is different for Units and for EtherCAT slaves.

● Checking the Unit Version of an NJ-series CPU Unit

You can use the Production Information while the Sysmac Studio is online to check the unit version of a Unit. You can do this for the CPU Unit, CJ-series Special I/O Units, and CJ-series CPU Bus Units. You cannot check the unit versions of CJ-series Basic I/O Units with the Sysmac Studio.

Use the following procedure to check the unit version.

- 1 Double-click **CPU/Expansion Racks** under **Configurations and Setup** in the Multiview Explorer. Or, right-click **CPU/Expansion Racks** under **Configurations and Setup** and select **Edit** from the menu.

The Unit Editor is displayed.

- 2 Right-click any open space in the Unit Editor and select **Production Information**.

The Production Information Dialog Box is displayed.

● Checking the Unit Version of an NY-series Controller

You can use the Production Information while the Sysmac Studio is online to check the unit version of a Unit. You can only do this for the Controller.

- 1 Right-click **CPU Rack** under **Configurations and Setup - CPU/Expansion Racks** in the Multiview Explorer and select **Production Information**.

The Production Information Dialog Box is displayed.

● Changing Information Displayed in Production Information Dialog Box

- 1 Click the **Show Detail** or **Show Outline** Button at the lower right of the **Production Information** Dialog Box.

The view will change between the production information details and outline.

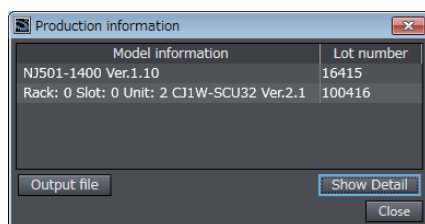

Outline View

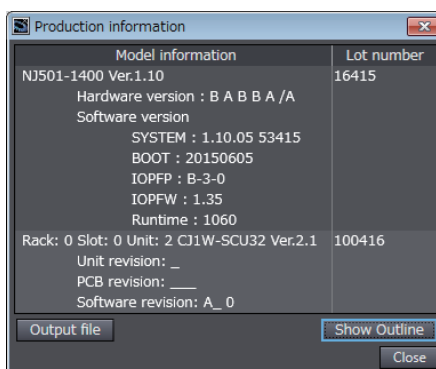

Detail View

The information that is displayed is different for the Outline View and Detail View. The Detail View displays the unit version, hardware version, and software versions. The Outline View displays only the unit version.

Note The hardware revision is separated by “/” and displayed on the right of the hardware version.

● **Checking the Unit Version of an EtherCAT Slave**

You can use the Production Information while the Sysmac Studio is online to check the unit version of an EtherCAT slave. Use the following procedure to check the unit version.

- 1** Double-click **EtherCAT** under **Configurations and Setup** in the Multiview Explorer. Or, right-click **EtherCAT** under **Configurations and Setup** and select **Edit** from the menu.
The EtherCAT Tab Page is displayed.
- 2** Right-click the master on the EtherCAT Tab Page and select **Display Production Information**.
The Production Information Dialog Box is displayed.
The unit version is displayed after “Rev.”

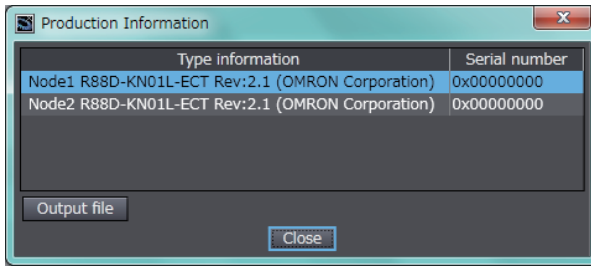

● **Changing Information Displayed in Production Information Dialog Box**

- 1** Click the **Show Detail** or **Show Outline** Button at the lower right of the **Production Information** Dialog Box.
The view will change between the production information details and outline.

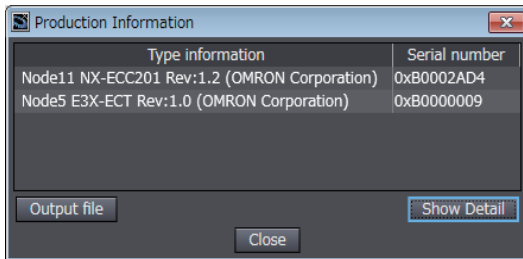

Outline View

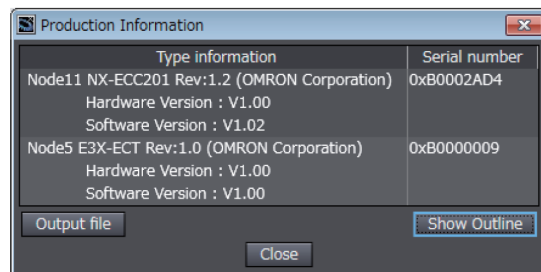

Detail View

Related Manuals

The following manuals are related. Use these manuals for reference.

Manual name	Cat. No.	Model numbers	Application	Description
NJ-series CPU Unit Hardware User's Manual	W500	NJ501-□□□□ NJ301-□□□□ NJ101-□□□□	Learning the basic specifications of the NJ-series CPU Units, including introductory information, designing, installation, and maintenance. Mainly hardware information is provided.	An introduction to the entire NJ-series system is provided along with the following information on the CPU Unit. <ul style="list-style-type: none"> • Features and system configuration • Introduction • Part names and functions • General specifications • Installation and wiring • Maintenance and inspection
NJ/NX-series CPU Unit Software User's Manual	W501	NX701-□□□□ NX102-□□□□ NX1P2-□□□□ NJ501-□□□□ NJ301-□□□□ NJ101-□□□□	Learning how to program and set up an NJ/NX-series CPU Unit. Mainly software information is provided.	The following information is provided on a Controller built with an NJ/NX-series CPU Unit. <ul style="list-style-type: none"> • CPU Unit operation • CPU Unit features • Initial settings • Programming based on IEC 61131-3 language specifications
NJ/NX-series Instructions Reference Manual	W502	NX701-□□□□ NX102-□□□□ NX1P2-□□□□ NJ501-□□□□ NJ301-□□□□ NJ101-□□□□	Learning detailed specifications on the basic instructions of an NJ/NX-series CPU Unit.	The instructions in the instruction set (IEC 61131-3 specifications) are described.
NJ/NX-series CPU Unit Motion Control User's Manual	W507	NX701-□□□□ NX102-□□□□ NX1P2-□□□□ NJ501-□□□□ NJ301-□□□□ NJ101-□□□□	Learning about motion control settings and programming concepts.	The settings and operation of the CPU Unit and programming concepts for motion control are described.
NJ/NX-series Motion Control Instructions Reference Manual	W508	NX701-□□□□ NX102-□□□□ NX1P2-□□□□ NJ501-□□□□ NJ301-□□□□ NJ101-□□□□	Learning about the specifications of the motion control instructions.	The motion control instructions are described.
NJ/NX-series CPU Unit Built-in EtherCAT® Port User's Manual	W505	NX701-□□□□ NX102-□□□□ NX1P2-□□□□ NJ501-□□□□ NJ301-□□□□ NJ101-□□□□	Using the built-in EtherCAT port on an NJ/NX-series CPU Unit.	Information on the built-in EtherCAT port is provided. This manual provides an introduction and provides information on the configuration, features, and setup.
NJ/NX-series CPU Unit Built-in EtherNet/IP™ Port User's Manual	W506	NX701-□□□□ NX102-□□□□ NX1P2-□□□□ NJ501-□□□□ NJ301-□□□□ NJ101-□□□□	Using the built-in EtherNet/IP port on an NJ/NX-series CPU Unit.	Information on the built-in EtherNet/IP port is provided. Information is provided on the basic setup, tag data links, and other features.
NJ/NY-series NC Integrated Controller User's Manual	O030	NJ501-5300 NY532-5400	Performing numerical control with NJ/NY-series Controllers.	Describes the functionality to perform the numerical control. Use this manual together with the <i>NJ/NY-series G code Instructions Reference Manual</i> (Cat. No. O031) when programming.
NJ/NY-series G code Instructions Reference Manual	O031	NJ501-5300 NY532-5400	Learning about the specifications of the G code/M code instructions.	The G code/M code instructions are described. Use this manual together with the <i>NJ/NY-series NC Integrated Controller User's Manual</i> (Cat. No. O030) when programming.

Manual name	Cat. No.	Model numbers	Application	Description
NJ/NX-series Troubleshooting Manual	W503	NX701-□□□□ NX102-□□□□ NX1P2-□□□□ NJ501-□□□□ NJ301-□□□□ NJ101-□□□□	Learning about the errors that may be detected in an NJ/NX-series Controller.	Concepts on managing errors that may be detected in an NJ/NX-series Controller and information on individual errors are described.
Sysmac Studio Version 1 Operation Manual	W504	SYSMAC-SE2□□□	Learning about the operating procedures and functions of the Sysmac Studio.	Describes the operating procedures of the Sysmac Studio.
CNC Operator Operation Manual	O032	SYSMAC-RTNC0□□□D	Learning an introduction of the CNC Operator and how to use it.	An introduction of the CNC Operator, installation procedures, basic operations, connection operations, and operating procedures for main functions are described.
NY-series IPC Machine Controller Industrial Panel PC Hardware User's Manual	W557	NY532-1□□□	Learning the basic specifications of the NY-series Industrial Panel PCs, including introductory information, designing, installation, and maintenance. Mainly hardware information is provided.	An introduction to the entire NY-series system is provided along with the following information on the Industrial Panel PC. <ul style="list-style-type: none"> • Features and system configuration • Introduction • Part names and functions • General specifications • Installation and wiring • Maintenance and inspection
NY-series IPC Machine Controller Industrial Box PC Hardware User's Manual	W556	NY512-1□□□	Learning the basic specifications of the NY-series Industrial Box PC, including introductory information, designing, installation, and maintenance. Mainly hardware information is provided.	An introduction to the entire NY-series system is provided along with the following information on the Industrial Box PC. <ul style="list-style-type: none"> • Features and system configuration • Introduction • Part names and functions • General specifications • Installation and wiring • Maintenance and inspection
NY-series IPC Machine Controller Industrial Panel PC / Industrial Box PC Setup User's Manual	W568	NY532-1□□□ NY512-1□□□	Learning the initial settings of the NY-series Industrial PCs and preparations to use Controllers.	The following information is provided on an introduction to the entire NY-series system. <ul style="list-style-type: none"> • Two OS systems • Initial settings • Industrial PC Support Utility • NYCompolet • Industrial PC API • Backup & recovery
NY-series IPC Machine Controller Industrial Panel PC / Industrial Box PC Software User's Manual	W558	NY532-1□□□ NY512-1□□□	Learning how to program and set up the Controller functions of an NY-series Industrial PC.	The following information is provided on the NY-series Controller functions. <ul style="list-style-type: none"> • Controller operations • Controller functions • Controller settings • Programming based on IEC 61131-3 language specifications
NY-series Instructions Reference Manual	W560	NY532-1□□□ NY512-1□□□	Learning detailed specifications on the basic instructions of an NY-series Industrial PC.	The instructions in the instruction set (IEC 61131-3 specifications) are described.
NY-series IPC Machine Controller Industrial Panel PC / Industrial Box PC Motion Control User's Manual	W559	NY532-1□□□ NY512-1□□□	Learning about motion control settings and programming concepts of an NY-series Industrial PC.	The settings and operation of the Controller and programming concepts for motion control are described.

Manual name	Cat. No.	Model numbers	Application	Description
NY-series Motion Control Instructions Reference Manual	W561	NY532-1□□□ NY512-1□□□	Learning about the specifications of the motion control instructions of an NY-series Industrial PC.	The motion control instructions are described.
NY-series IPC Machine Controller Industrial Panel PC / Industrial Box PC Built-in EtherCAT® Port User's Manual	W562	NY532-1□□□ NY512-1□□□	Using the built-in EtherCAT port in an NY-series Industrial PC.	Information on the built-in EtherCAT port is provided. This manual provides an introduction and provides information on the configuration, features, and setup.
NY-series IPC Machine Controller Industrial Panel PC / Industrial Box PC Built-in EtherNet / IP™ Port User's Manual	W563	NY532-1□□□ NY512-1□□□	Using the built-in EtherNet/IP port in an NY-series Industrial PC.	Information on the built-in EtherNet/IP port is provided. Information is provided on the basic setup, tag data links, and other features.
NY-series Troubleshooting Manual	W564	NY532-1□□□ NY512-1□□□	Learning about the errors that may be detected in an NY-series Industrial PC.	Concepts on managing errors that may be detected in an NY-series Controller and information on individual errors are described.

Terminology

Term	Description
NJ501-1□□□	Represents NJ501-1300/-1400/-1500.

Revision History

A manual revision code appears as a suffix to the catalog number on the front and back covers of the manual.

Cat. No.	O031-E1-02
-----------------	-------------------

↑
Revision code

Revision code	Date	Revised content
01	October 2017	Original production
02	July 2018	<ul style="list-style-type: none"> • Added information on the NX102-□□□□. • Corrected mistakes.

1

Basic Information on NC Programming

This section provides the list of available instructions, and the descriptions of parameters and modal.

Instructions	1-2
G Codes	1-2
M Codes	1-4
Instruction Parameters	1-5
G Code Descriptions	1-7
What is Modal?	1-9

Instructions

The following table lists the G codes and M codes supported by NJ501-5300 and NJ532-5400.

G Codes

Modal group	Initial modal	Instruction	Name	Outline of function
00 Non-modal	---	G04	Dwell	Stops the CNC coordinate system for a predefined period of time.
00 Non-modal	---	G09	Exact Stop	Executes a forcible control deceleration stop together with the registration of in-position at the termination of a block.
00 Non-modal	---	G28	Return to Reference Point	Moves the tool to the reference point (position 0) via the middle point specified by an argument of the instruction.
00 Non-modal	---	G30	Return to 2nd, 3rd or 4th Reference Point	Moves the tool to the 2nd, 3rd and 4th reference point.
00 Non-modal	---	G31	Skip Function	Provides Rapid Positioning (G00) and input stop.
00 Non-modal	---	G52	Local Coordinate System Set	Creates coordinates in the Work Coordinate System.
00 Non-modal	---	G53	Dimension Shift Cancel	Runs commands in the machine coordinate system.
01 Rapid Positioning	G01	G00	Rapid Positioning	Performs a point-to-point operation in the minimum time by following the restrictions of CNC motor settings.
		G01	Linear Interpolation	Moves a CNC motor from the current position to a specified position.
		G02	Circular Interpolation in CW direction	Moves the tool on an arc path on the XY, YZ, or ZX plane.
		G03	Circular Interpolation in CCW direction	
02 Plane	G17	G17	X-Y Plane Selection	Changes a plane, the reference of Circular Interpolation (G02/G03), Cutter Compensation (G40/G41/G42), and Coordinate System Rotation (G68/G69).
		G18	Z-X Plane Selection	
		G19	Y-Z Plane Selection	
03 Distance	G90	G90	Absolute command	Enables absolute position mode for all axes in the CNC coordinate system, and moves the axes to a specified position in the current coordinate system.
		G91	Incremental command	Enables relative Incremental position mode for all axes in the CNC coordinate system, and moves the axes a certain distance from the last command position.
06 Unit	Operation depends on the Orthogonal Axis Command Unit setting	G20	Inch input	Switches all the settings of the CNC coordinate system, command values, and the unit of current values.
		G21	Metric input	

Modal group	Initial modal	Instruction	Name	Outline of function
07 Tool radius	G40	G40	Cancels tool compensation	Enables selection of a tool for control, automatically moves the tool to the left side or right side of the programmed path, and correct the radius of the tool.
		G41	Tool Compensation, left	
		G42	Tool Compensation, right	
08 Tool length offset	G49	G43	Tool Offset, positive	Corrects the position in the Z-axis direction.
		G44	Tool Offset, negative	
		G49	Cancels tool offset	
09 Fixed cycle	G80	G74	Left-handed Tapping Cycle	Performs reverse tapping machining.
		G80	Fixed Cycle Cancel	Cancels a fixed cycle.
		G84	Tapping Cycle	Performs tapping machining.
10 Return level	G98	G98	Fixed Cycle Return to Initial Level	Sets the return position of a fixed cycle to the initial level.
		G99	Fixed Cycle Return to R Point Level	Sets the return position of a fixed cycle to the R point level.
11 Scaling	G50	G50	Cancel scaling	Scales the current coordinate system.
		G51	Scaling	
14 Coordinate System Selection	No Work Coordinate System is selected (all coordinate axis have zero offset).	G54	1st Work Coordinate System selection	Changes the current coordinate system to a specified one defined by the user by using the offsets of X-, Y-, Z-, A-, B-, and C-axis.
		G55	2nd Work Coordinate System selection	
		G56	3rd Work Coordinate System selection	
		G57	4th Work Coordinate System selection	
		G58	5th Work Coordinate System selection	
		G59	6th Work Coordinate System selection	
15 Path Control	G64	G61	Exact Stop Mode	Stops operation between blocks to prevent corner rounding and blending from being executed.
		G64	Continuous-path Mode	When two or more sequential operations are aligned, the former can be blended with the latter and accelerated/decelerated.
16 Rotation	G69	G68	Enables rotation	Rotates the current coordinates.
		G69	Disables rotation	
22 Mirroring	G50.1	G50.1	Cancel Mirroring	Mirrors the current coordinates.
		G51.1	Mirroring	
23 Multi-block Acceleration/Deceleration Rate	G501	G500	Enables multi-block acceleration/deceleration rate	Reads the path ahead, and adjusts the acceleration or deceleration rate.
		G501	Disables multi-block acceleration/deceleration rate	

M Codes

Type	Instruction	Name	Outline of function
Reservation auxiliary func- tion output	M00	Program Stop	Stops the execution of the NC program at the block where M00 is commanded.
	M01	Optional Stop	As is the case with M00, stops the execution of the NC program at the block where M01 is commanded.
	M02/M30	End of Program	Stops the NC program to enable reset mode.
Spindle Axis	M03	Spindle CW	Operates the Spindle axis in the positive direction at the specified speed.
	M04	Spindle CCW	Operates the Spindle axis in the negative direction at the specified speed.
	M05	Spindle OFF	Stops the Spindle axis.
	M19	Spindle Orienta- tion	Uses this command to adjust orientation of the spindle axis when you replace tools and carry out other tasks.
Programming	M98	Subprogram Call	Calls a subprogram from the program currently running.
	M99	Subprogram End	Terminates the subprogram currently running and returns to the main program from which the subprogram was invoked.

Instruction Parameters

The following describes the parameters used in each instruction.

Parameter	Description	Relevant codes	Recommended range
A	Target A-axis Position [command units]	G00/G01/G02/G03	$-1,000,000 \leq A \leq 1,000,000$
	A-axis middle point [command units]	G28/G30	$-1,000,000 \leq A \leq 1,000,000$
	A-axis offset [command units]	G52	$-1,000,000 \leq A \leq 1,000,000$
B	Target B-axis Position [command units]	G00/G01/G02/G03	$-1,000,000 \leq B \leq 1,000,000$
	B-axis middle point [command units]	G28/G30	$-1,000,000 \leq B \leq 1,000,000$
	B-axis offset [command units]	G52	$-1,000,000 \leq B \leq 1,000,000$
C	Target C-axis Position [command units]	G00/G01/G02/G03	$-1,000,000 \leq C \leq 1,000,000$
	C-axis middle point [command units]	G28/G30	$-1,000,000 \leq C \leq 1,000,000$
	C-axis offset [command units]	G52	$-1,000,000 \leq C \leq 1,000,000$
F	Feedrate [command units]	G00/G01/G02/G03	$0.00000001 \leq F \leq \text{MAX feedrate (CNC coordinate system setting)}$
	Dwell time [s]	G04	$0 \leq F \leq 100,000$
G	G code	---	Valid G code
I	X-axis arc center [command units]	G02/G03	$-1,000,000 \leq I \leq 1,000,000$
	X-axis scaling magnification	G51	$0.00001 \leq I \leq 10,000$ $-10,000 \leq I \leq -0.00001$
J	Y-axis arc center [command units]	G02/G03	$-1,000,000 \leq J \leq 1,000,000$
	Y-axis scaling magnification	G51	$0.00001 \leq J \leq 10,000$ $-10,000 \leq J \leq -0.00001$
K	Z-axis arc center [command units]	G02/G03	$-1,000,000 \leq K \leq 1,000,000$
	Z-axis scaling magnification	G51	$0.00001 \leq K \leq 10,000$ $-10,000 \leq K \leq -0.00001$
	Number of repetitions	G74/G84	$0 \leq K \leq 10,000$
L	L-variable address	---	Valid address (L0 to L255)
	Number of loops	M98	$0 \leq L \leq 10,000$
M	M Code	---	Valid M code (M0 to M191)
P	P-variable address	---	Valid address (P0 to P32767)
	Dwell time [ms]	G04/G74/G84	$0 \leq P \leq 100,000,000$
	Reference point specification	G30	Valid reference point number (P2 to P4)
	All axes scaling magnification	G51	$0.00001 \leq P \leq 10,000$
	Program number	M98	Programmed by Sysmac Studio 1000 to 2999 Programmed by HMI 3000 to 9999
Q	Q-variable address	---	Valid address (Q0 to Q4095)
R	Arc radius [command units]	G02/G03	$-1,000,000 \leq R \leq 1,000,000$
	Rotation angle [deg]	G68	$-360 \leq R \leq 360$
	R Point Level [command units]	G74/G84	$-1,000,000 \leq R \leq 1,000,000$
S	Spindle rotation speed [r/min]	M03/M04/M19	$0 \leq S \leq \text{MAX speed (CNC motor setting)}$

Parameter	Description	Relevant codes	Recommended range
X	Target X-axis Position [command units]	G00/G01/G02/G03	$-1,000,000 \leq X \leq 1,000,000$
	Dwell time [s]	G04	$0 \leq X \leq 100,000$
	X-axis middle point [command units]	G28/G30	$-1,000,000 \leq X \leq 1,000,000$
	X-axis center [command units]	G50/G50.1/G68	$-1,000,000 \leq X \leq 1,000,000$
	X-axis offset [command units]	G52	$-1,000,000 \leq X \leq 1,000,000$
Y	Target Y-axis position [command units]	G00/G01/G02/G03	$-1,000,000 \leq Y \leq 1,000,000$
	Y-axis middle point [command units]	G28/G30	$-1,000,000 \leq Y \leq 1,000,000$
	X-axis center [command units]	G50/G50.1/G68	$-1,000,000 \leq Y \leq 1,000,000$
	Y-axis offset [command units]	G52	$-1,000,000 \leq Y \leq 1,000,000$
Z	Target Z-axis position [command units]	G00/G01/G02/G03	$-1,000,000 \leq Z \leq 1,000,000$
	Z-axis middle point [command units]	G28/G30	$-1,000,000 \leq Z \leq 1,000,000$
	Z-axis center [command units]	G50/G50.1/G68	$-1,000,000 \leq Z \leq 1,000,000$
	Z-axis offset [command units]	G52	$-1,000,000 \leq Z \leq 1,000,000$
	Z-point position [command units]	G74/G84	$-1,000,000 \leq Z \leq 1,000,000$
ta	Acceleration time [ms]	G01/G02/G03	$0 \leq ta \leq 250,000$
td	Deceleration time [ms]	G01/G02/G03	$0 \leq td \leq 250,000$
ts	Jerk Time [ms]	G01/G02/G03	$0 \leq ts \leq 125,000$

There is no modal group for feedrate F, spindle rotation speed S, acceleration time ta, deceleration time td, and Jerk time ts, but it operates as the modal to maintain the commanded state.

G Code Descriptions

The program format generally called the G code is defined by ISO 6983 (JIS B 6315).

A combination of characters such as G, M and X, and digits is called a word, and a line consisting of two or more words are called a block. G codes are executed sequentially in units of a block. When execution of the current block is completed, the next block is executed in principle. A line feed code indicates the end of block. The length of one block must be 1020 bytes or less. These restrictions apply to blocks after program parsing. Refer to *Program Parsing by CNC Operator* on page A-2 for program parsing.

The influential range varies depending on the word. A word that only has an effect in the block where it is written is called non-modal, and one that continues to have an effect when omitted in subsequent blocks is called modal. In the modal, a few words produce their effects exclusively. This is called a modal group.

Comments can be entered by using “//” before the comment, which is valid to the end of the block. This specification is not defined by ISO 6983.

The spindle operations, F, and M30 need to be described. M30 can be written as M02.

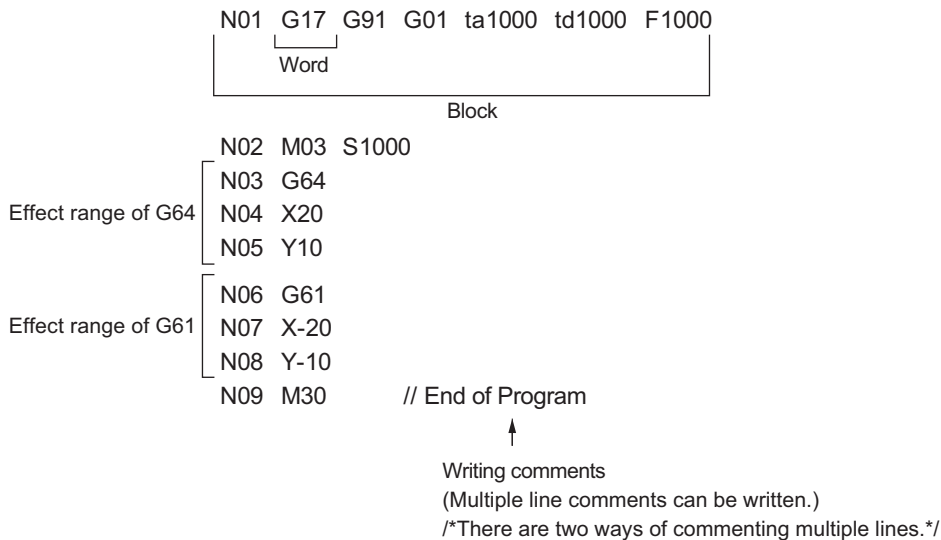

* G61 and G64 are in the same modal group and if another one is written, the subsequent modal changes.

Optional Skip Block

If an optional signal is entered, the block where the related command is written is skipped.

Enter the command as /N*1.

*1. N is a constant from 1 to 31.

```
G17 G91 G01 ta1000 td1000 F1000 S1000 M03
G64
/1 X20 // The optional block skip can be written at the
beginning of line only.
/ Y10 // If N is omitted, /1 is assumed.
G61
/1/2 X-20 // Multiple numbers can be specified.
Y-10
M30
```

Note that the optional block skip can be used for G codes only.

It cannot be used for program codes.

What is Modal?

There are two types of G codes: One that is valid only in its block, and the other that continues to be valid until another G code of the same group is specified. The former is called non-modal G code, and the latter modal G code.

Modal G codes are summarized into some G code groups. The group is called a modal group.

In the same modal group, G codes that cannot hold simultaneously are summarized. One of the G-code states is always preserved. For example, G90 (Absolute Dimension) and G91 (Incremental Dimension) are summarized into modal group 03.

Refer to *Instructions* on page 1-2 for information about which G code is summarized in which modal group.

2

G Code

This section describes the specifications of the G code.

Interpolation Functions	2-3
Dwell	2-15
Feed Functions	2-17
Coordinate System	2-27
Reference Point	2-35
Compensation Functions	2-39
Utilities	2-59

Interpolation Functions

Instruction	Name	Page
G00	Rapid Positioning	P. 2-4
G01	Linear Interpolation	P. 2-6
G02/G03	Circular Interpolation	P. 2-8
G31	Skip Function	P. 2-13

G00 Rapid Positioning

This instruction positions a tool.

Modal/Non-modal	Modal
Modal group	01 Rapid Positioning
Instruction format	G00 X- Y- Z- A- B- C-
Relevant G codes	G90, G91

Parameters

Parameter	Name	Description
X	Target X-axis Position	Specifies the destination position [command units] on the X-axis.
Y	Target Y-axis Position	Specifies the destination position [command units] on the Y-axis.
Z	Target Z-axis Position	Specifies the destination position [command units] on the Z-axis.
A	Target A-axis Position	Specifies the destination position [command units] on the A-axis.
B	Target B-axis Position	Specifies the destination position [command units] on the B-axis.
C	Target C-axis Position	Specifies the destination position [command units] on the C-axis.

Function

Use this command to position a tool.

It moves the tool from the current position to a specified position in the minimum period of time with the CNC motor parameters and CNC coordinate system parameters. Write the command according to the instruction format. The description of each coordinate can be omitted.

This function does not guarantee the trace. If the linear trace is required, use the linear interpolation (G01).

The command position follows the specifications for the Absolute Dimension (G90) and Incremental Dimension (G91).

Programming Example

The following program performs positioning with the absolute dimensions.

```
:  
N010 G90 // Absolute dimension  
N011 G00 X100 Y50
```

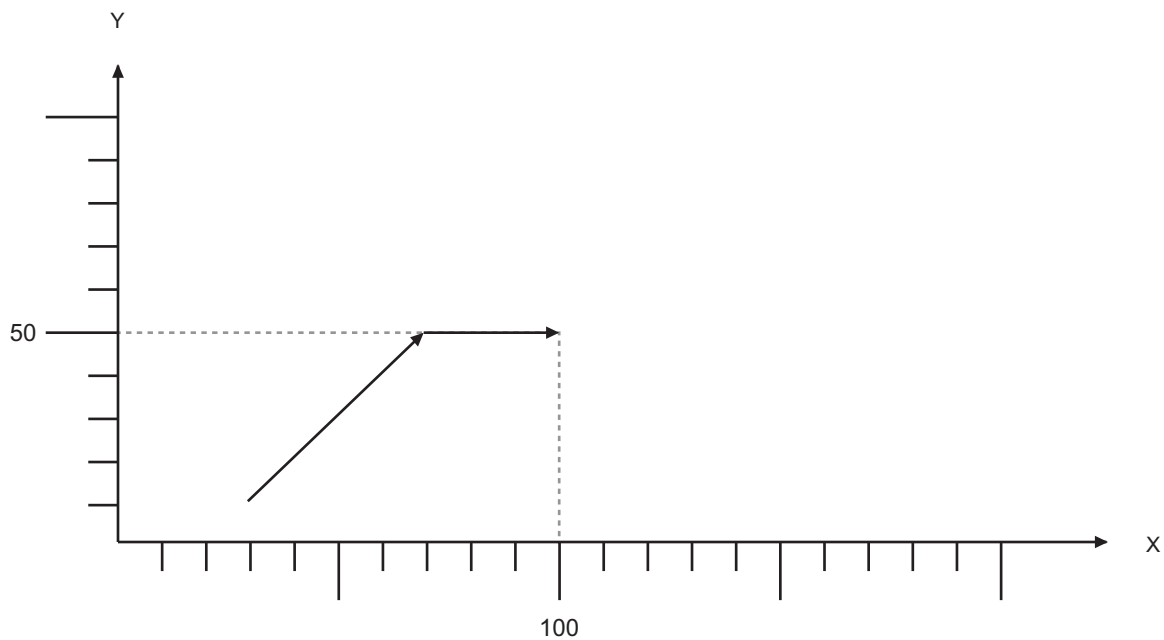

G01 Linear Interpolation

This instruction performs linear interpolation.

Modal/Non-modal	Modal
Modal group	01 Rapid Positioning
Instruction format	G01 F- ta- td- ts- X- Y- Z- A- B- C-
Relevant G codes	G90, G91, F, ta, td, ts

Parameters

Parameter	Name	Description
F	Target Velocity	Specifies the target velocity [command units/min].
ta	Acceleration Time	Specifies the acceleration time [ms].
td	Deceleration Time	Specifies the deceleration time [ms].
ts	Jerk Time	Specifies the jerk time [ms].
X	Target X-axis Position	Specifies the destination position [command units] on the X-axis.
Y	Target Y-axis Position	Specifies the destination position [command units] on the Y-axis.
Z	Target Z-axis Position	Specifies the destination position [command units] on the Z-axis.
A	Target A-axis Position	Specifies the destination position [command units] on the A-axis.
B	Target B-axis Position	Specifies the destination position [command units] on the B-axis.
C	Target C-axis Position	Specifies the destination position [command units] on the C-axis.

Function

This command moves the CNC motor with the specified velocity, acceleration time, deceleration time, and jerk time to operate a tool linearly from the current position to a target position.

Unlike G00, if two or more continuous operating functions are aligned, the commands are blended to accelerate or decelerate.

The command position follows the specifications for the Absolute Dimension (G90) and Incremental Dimension (G91).

G01 uses the following settings for its operation.

Command	Description	Unit
F	Target Velocity	command unit/min
ta	Acceleration Time	ms
td	Deceleration Time	ms
ts	Jerk Time	ms

The F command calculates velocity by using X-, Y-, and Z-axis. If the user selects A-, B-, or C-axis, the axis is operated at the rotational axis speed.

For relationship between acceleration time, deceleration time, and jerk time and the speed waveforms, refer to the programming example of *G64 Continuous-path Mode* on page 2-22.

Programming Example

The following program performs linear interpolation with the absolute dimension.

```

:
N010 G90                // Absolute dimension
N011 G01 X100 Y50 F300
:

```

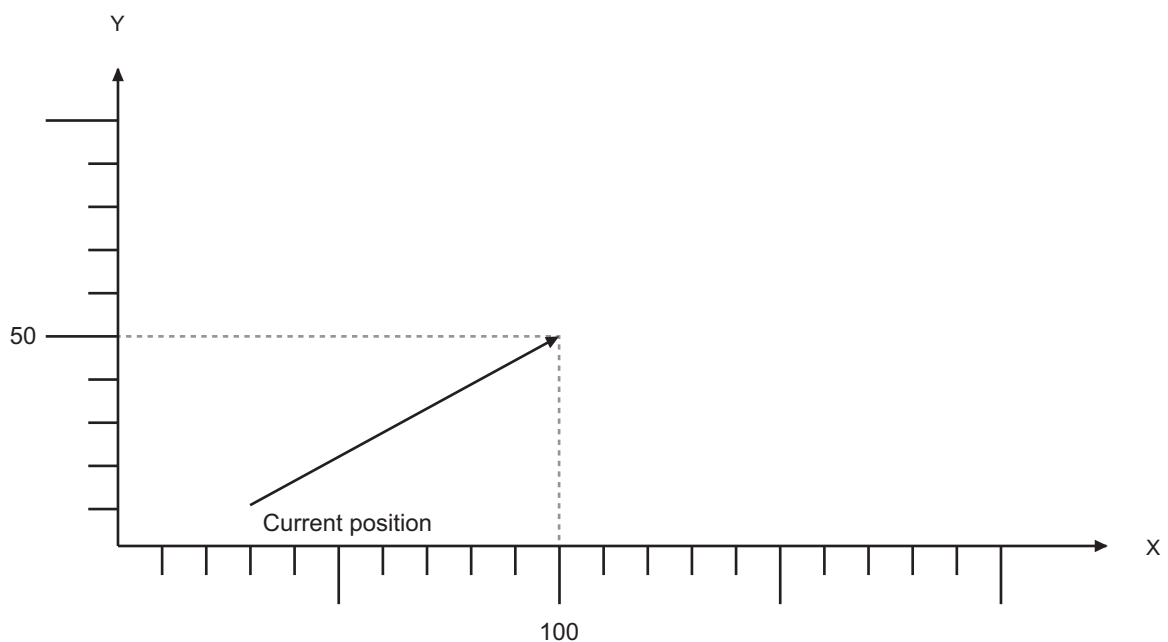

G02, G03 Circular Interpolation

These instructions perform circular interpolation.

Modal/Non-modal		Modal	
Modal group		01 Rapid Positioning	
Instruction format	Circular Interpolation in CW direction	When specifying the arc center	G02 F- ta- td- ts- X- Y- Z- I- J- K- A- B- C-
		When specifying the arc radius	G02 F- ta- td- ts- X- Y- Z- R- A- B- C-
	Circular Interpolation in CCW direction	When specifying the arc center	G03 F- ta- td- ts- X- Y- Z- I- J- K- A- B- C-
		When specifying the arc radius	G03 F- ta- td- ts- X- Y- Z- R- A- B- C-
Relevant G codes		G90, G91, G17, G18, G19	

Parameters

Parameter	Name	Description
F	Target Velocity	Specifies the target velocity [command units/min].
ta	Acceleration Time	Specifies the acceleration time [ms].
td	Deceleration Time	Specifies the deceleration time [ms].
ts	Jerk Time	Specifies the jerk time [ms].
X	Target X-axis Position	Specifies the destination position [command units] on the X-axis.
Y	Target Y-axis Position	Specifies the destination position [command units] on the Y-axis.
Z	Target Z-axis Position	Specifies the destination position [command units] on the Z-axis.
A	Target A-axis Position	Specifies the destination position [command units] on the A-axis.
B	Target B-axis Position	Specifies the destination position [command units] on the B-axis.
C	Target C-axis Position	Specifies the destination position [command units] on the C-axis.
I	X-axis arc center	Specifies the arc center [command units] on the X-axis.
J	Y-axis arc center	Specifies the arc center [command units] on the Y-axis.
K	Z-axis arc center	Specifies the arc center [command units] on the Z-axis.
R	Arc radius	Specifies the arc radius [command units].

Function

This command moves CNC motors with the specified velocity, acceleration time, deceleration time, and jerk time to operate a tool in an arc motion from the current position to a target position.

For relationship between acceleration time, deceleration time, and jerk time and the speed waveforms, refer to the programming example of *G64 Continuous-path Mode* on page 2-22.

When this command is executed, the arc path is calculated on the XY, YZ, or ZX plane. If you select an axis other than those composing the plane to specify a position, the path is linear.

If both IJK and R are omitted, an error occurs. Also, if R0 is specified, the linear path is set.

Programming Example

- The following shows circular interpolation with Arc center specification

```

:
N010 G90 .....Absolute dimension
N011 G17 .....XY Plane selection
N010 G02 X100 Y90 I0 J40 F300
:

```

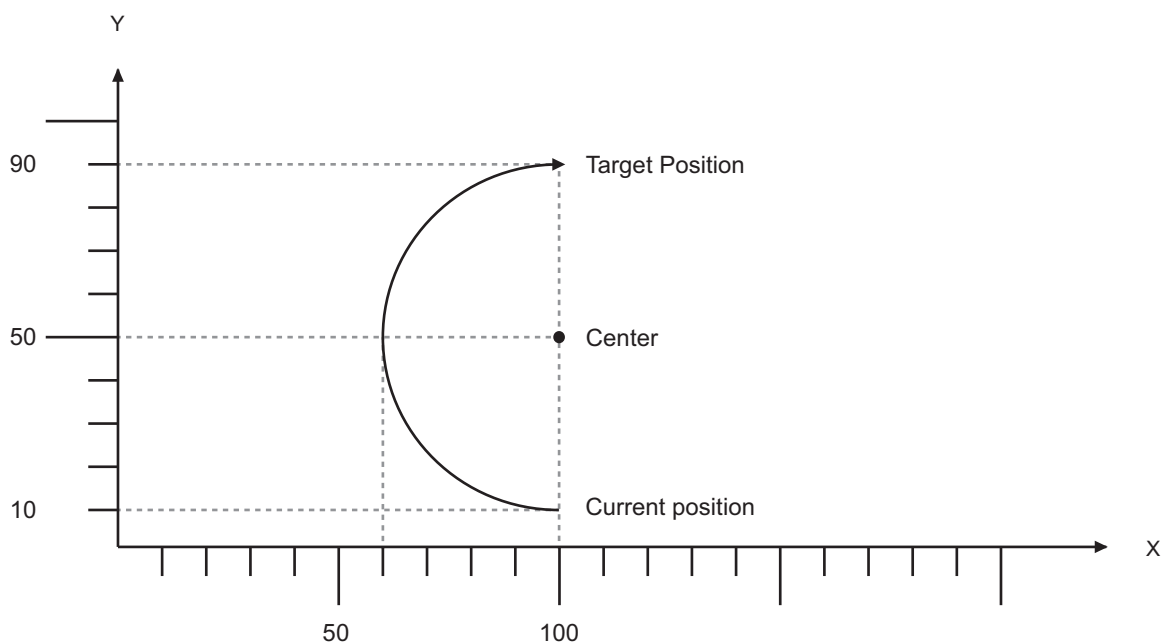

● The following shows circular interpolation with Arc radius specification (radius < 0)

```

:
N010 G90 ..... Absolute dimension
N011 G17 ..... XY Plane selection
N012 G02 X140 Y50 R-40 F300
:

```

When radius < 0, a circle larger than a semicircle is drawn.

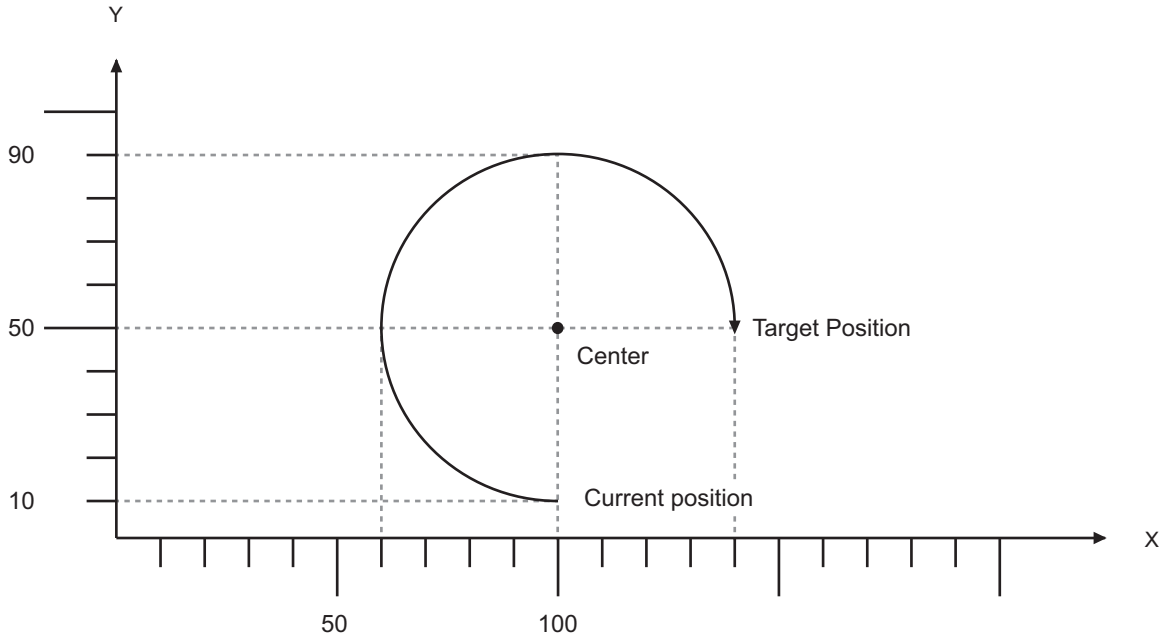

● The following shows circular interpolation with Arc radius specification (radius > 0)

```

:
N010 G91 ..... Incremental dimension
N011 G17 ..... XY Plane selection
N012 G02 X40 Y40 R40 F300
:

```

When radius > 0, a circle smaller than a semicircle is drawn.

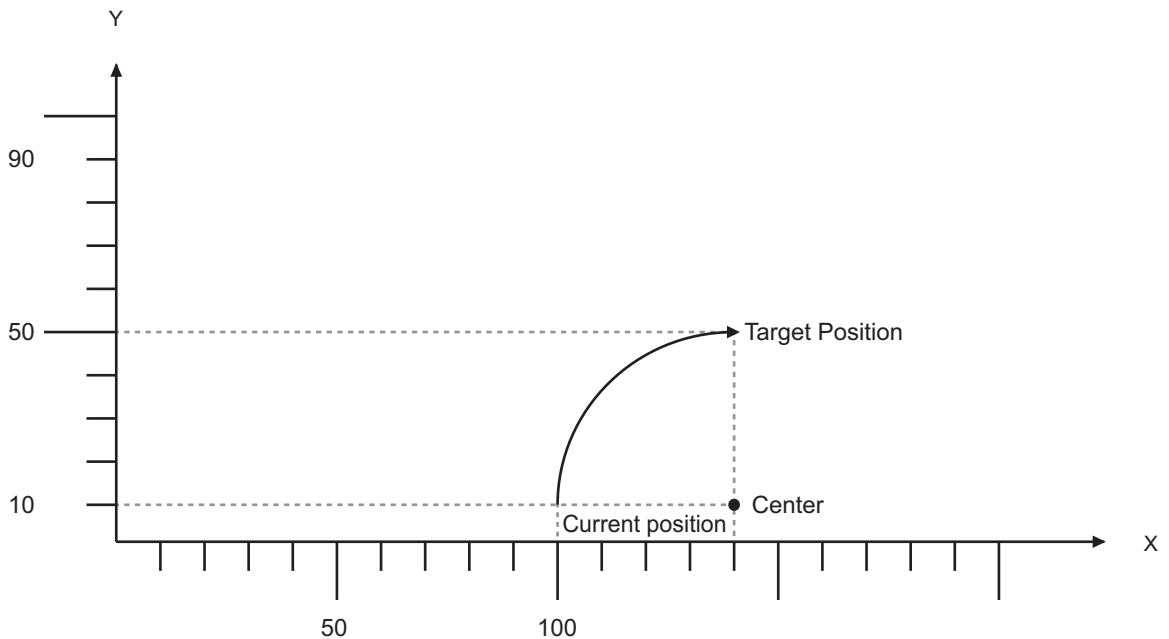

● Spiral interpolation

```

N01 G17 G64 G91 F1000
N02 M03 S300
N03 G02 Y10 J50 // First rotation of spiral interpolation
N04 Y10 J40 // Second rotation of spiral interpolation
N05 Y10 J30 // Third rotation of spiral interpolation
N06 M05
N07 M30 // End of program

```

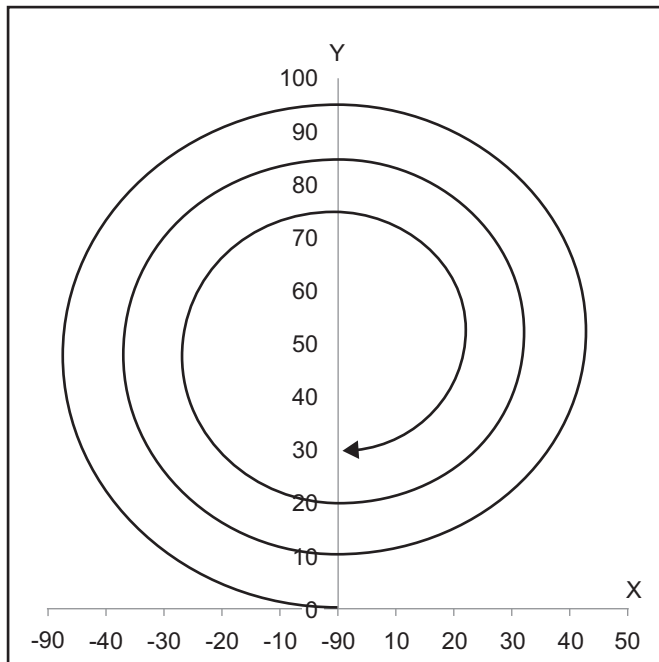

● Helical interpolation

```

N01 G17 G64 G91 F1000
N02 M03 S300
N03 G02 J50 Z10 // First rotation of helical interpolation
N04 J50 Z10 // Second rotation of helical interpolation
N05 J50 Z10 // Third rotation of helical interpolation
N06 M05
N07 M30 // End of program

```

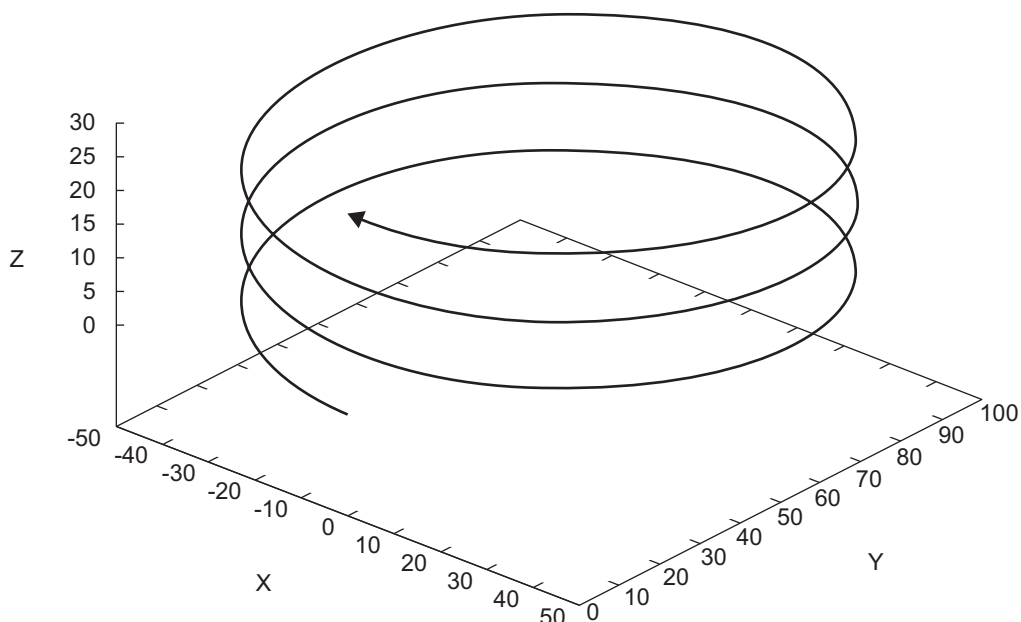

● Conical interpolation

```
N01 G17 G64 G91 F1000
N02 M03 S300
N03 G02 Y10 J50 Z10 // First rotation of conical interpolation
N04 Y10 J40 Z10     // Second rotation of conical interpolation
N05 Y10 J30 Z10     // Third rotation of conical interpolation
N06 M05
N07 M30             // End of program
```

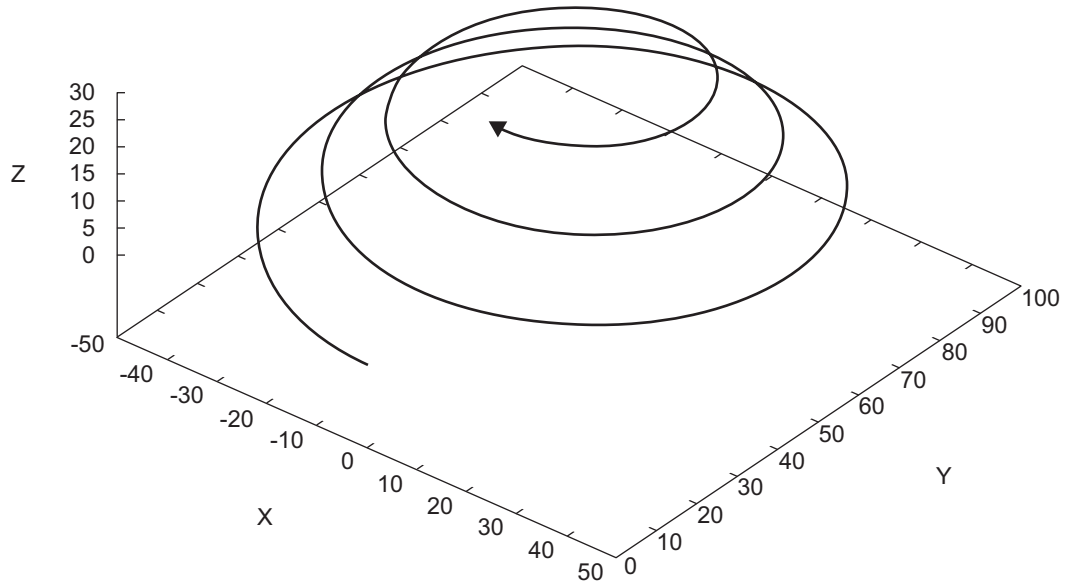

G31 Skip Function

If a skip signal is input externally during execution of a movement command, the commanded movement is interrupted to execute commands in the next block.

Modal/Non-modal	Non-modal
Modal group	00 Non-modal
Instruction format	G31 X- Y- Z- A- B- C-
Relevant G codes	G90, G91

Parameters

Parameter	Name	Description
X	Target X-axis Position	Specifies the destination position [command units] on the X-axis.
Y	Target Y-axis Position	Specifies the destination position [command units] on the Y-axis.
Z	Target Z-axis Position	Specifies the destination position [command units] on the Z-axis.
A	Target A-axis Position	Specifies the destination position [command units] on the A-axis.
B	Target B-axis Position	Specifies the destination position [command units] on the B-axis.
C	Target C-axis Position	Specifies the destination position [command units] on the C-axis.

Function

This command interrupts movement with Rapid Positioning (G00) and external input. Each CNC motor assigned to a command axis operates independently to the command position.

All the CNC motors start moving simultaneously and operate according to respective parameters. If you want to unify external inputs, set the same signal for all the inputs.

Each CNC motor also stops independently. Until all of the CNC motors stop, the process does not proceed to the next block. This command is not blended with other operations.

If there is an input externally to a CNC motor, the motor is moved to the captured position. Otherwise, it stops at the command position. The basic operation is the same as that of Rapid Positioning (G00). The command position follows the specifications for the Absolute Dimension (G90) and Incremental Dimension (G91). The velocity must be specified as the Skip Velocity (CNC motor setting). For details, refer to the *NJ/NY-series NC Integrated Controller User's Manual* (Cat. No. O030). The user can read the positions captured by `_CNC_CapturedPosition()`, which are sorted in ascending order of CNC motor numbers. For example, if the CNC coordinate system has CNC motors 1/3/4, `_CNC_CapturedPosition(0)` indicates CNC motor 1, `_CNC_CapturedPosition(1)` indicates CNC motor 3, and `_CNC_CapturedPosition(2)` indicates CNC motor 4.

For inputting skip signal, consult the instruction manual provided by the machine tool manufacturer.

Programming Example

Use the skip function and measure the wear volume of tool length. In this example, the tool touches the sensor and skip signal is input while it moves toward the cutting surface. The stop position is captured using the skip signal, and notified to the sequence control program as an argument of M code output. Based on the captured position, calculate the wear volume of tool length in the sequence control program. For the procedure for setting the wear volume of tool length that was calculated, refer to the *How to Enable Tool Replacement* in the *NJ/NY-series NC Integrated Controller User's Manual* (Cat. No. O030).

```

N01 G17 G91 G64 F1000
N02 G28 X5 Y5 // Moves to the position to start measuring the
               wear volume of tool length.
N03 G31 Z-10 // Moves to the cutting surface.
N04 M101 VA[_CNC_CapturedPosition2] // Notification to the sequence control program
    tion2]
N05 M30
  
```

Use of M101 for transferring the captured data to the sequence control program is an example. When using this command, refer to the instruction manual provided by the machine tool manufacturer.

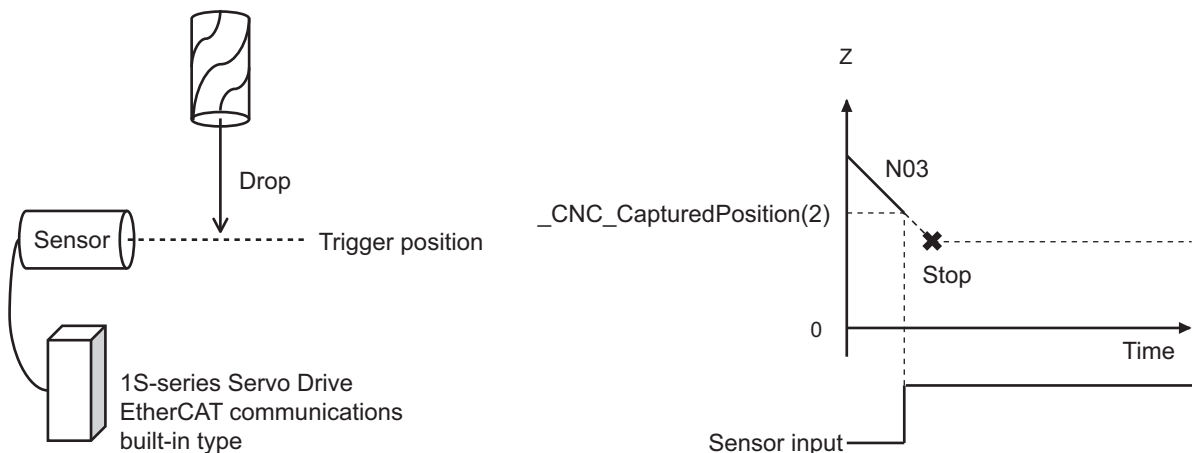

Dwell

Instruction	Name	Page
G04	Dwell	P. 2-16

G04 Dwell

This instruction stops the NC program only for a specified period of time.

Modal/Non-modal	Non-modal
Modal group	00 Non-modal
Instruction format	G04 F- G04 P- G04 X-
Relevant G codes	

Parameters

Parameter	Name	Description
F	Specification in seconds	Specifies a stop time [s] of the NC program.
X	Specification in seconds	Specifies a stop time [s] of the NC program.
P	Specification in milliseconds	Specifies a stop time [ms] of the NC program.

Function

The CNC coordinate system for which G04 is executed stops for the period of time specified by F, P, or X parameter indicating the number of seconds. The unit of time period specified by F or X parameter is second, and for P parameter is millisecond.

The G04 command only stops axis motions. It does not affect the spindle axis and device functions controlled by sequence control programs. If no parameter is specified, Dwell of 0 second, the default value will be executed.

Programming Example

The following program waits for 10 seconds between linear interpolations.

```

:
N010 G01 X100 Y100 F50
N011 G04 X10
N012 G01 X200 Y200
:

```



Feed Functions

Instruction	Name	Page
F Function	Feedrate Function (F function)	P. 2-18
ta/td/ts	Acceleration Time, Deceleration Time, Jerk Time	P. 2-19
G09	Exact Stop	P. 2-20
G61	Exact Stop Mode	P. 2-21
G64	Continuous-path Mode	P. 2-22
G500/G501	Multi-block Acceleration/Deceleration Rate	P. 2-24

Feedrate Function (F function)

This instruction specifies the feedrate.

Modal/Non-modal	Modal
Instruction format	F{data}
Relevant G codes	G01, G02, G03

This instruction specifies the feedrate using a numeric value after the F code.

Zero (0) and a negative value cannot be specified.

The velocity is specified in command units/min. (the feedrate per minute).

The positioning axis is not operated simply by specifying the feedrate.

Use a feed command to move the positioning axis.

For relationship between the feedrate and speed waveforms, refer to the programming example of *G64 Continuous-path Mode* on page 2-22.

Acceleration Time, Deceleration Time, Jerk Time

These instructions specify an acceleration time, deceleration time, and jerk time.

Modal/Non-modal		Modal
Instruction format	Acceleration Time	ta{data}
	Deceleration Time	td{data}
	Jerk Time	ts{data}
Relevant G codes		G01, G02, G03

Specify the acceleration time with a numeric value after the ta code. Specify the deceleration time with a numeric value after the td code. Specify the jerk time with a numeric value after the ts code.

The unit of time is in milliseconds.

For relationship between acceleration time, deceleration time, and jerk time and the speed waveforms, refer to the programming example of *G64 Continuous-path Mode* on page 2-22.

G09 Exact Stop

This instruction stops deceleration upon termination of the block that is currently running.

Modal/Non-modal	Non-modal
Modal group	00 Non-modal
Instruction format	G09
Relevant G codes	G01, G02, G03

Parameters

This command does not have any parameters to set.

Function

Executing G09 decelerates to a stop simultaneously with in-position check upon the termination of a block. It is used to prevent blending operations with the next block, such as cutting corners with an acute angle. This code is only valid for the current block.

Programming Example

Among movement commands between multiple blocks, the following program prevents blending operations between certain blocks, and decelerates to a stop.

```

N01 G01 G91 G64 F500           // Continuous-path mode
N02 X10
N03 G09 X10                   // N02 and N03 are not blended
N04 X10 G09                   // N04 and N05 are not blended
N05 X10
N06 M30

```

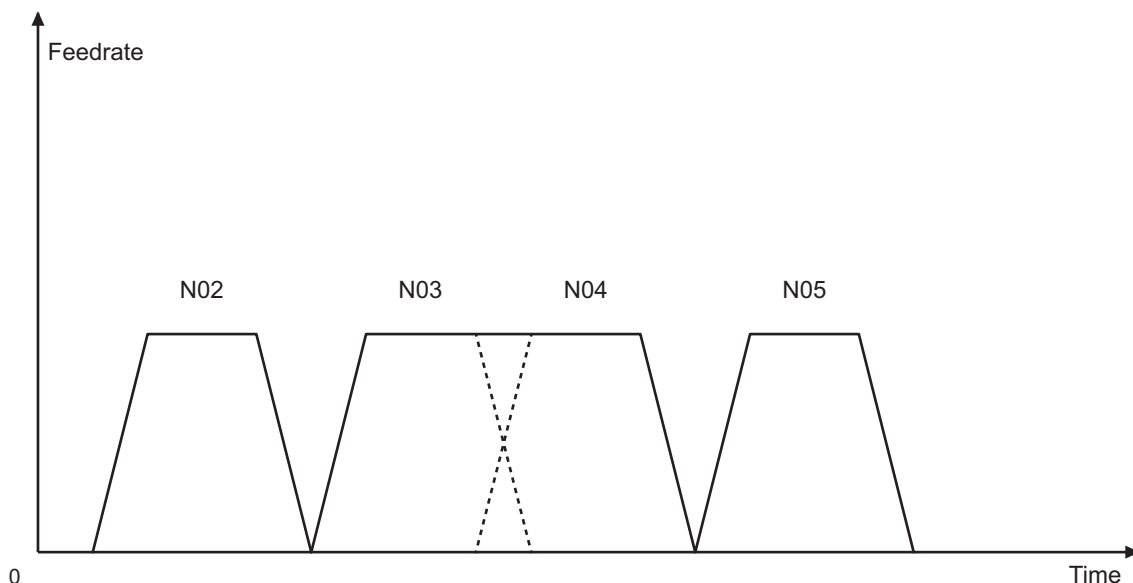

G61 Exact Stop Mode

This instruction stops operation between blocks to prevent corner blending from being executed.

Modal/Non-modal	Modal
Modal group	15 Path Control
Instruction format	G61
Relevant G codes	G01, G02, G03

Parameters

This command does not have any parameters to set.

Function

The G61 stops an operation between blocks to prevent the execution of blending of the corner and cutting corners with an acute angle during operation. When G61 is commanded, deceleration is applied to the end point of the cutting block, then an in-position check of each block is executed. G61 maintains the valid state until G64 (Continuous-path Mode) is commanded. Continuous-path Mode (G64) is the default value at startup.

Programming Example

Refer to the programming example of *G64 Continuous-path Mode* on page 2-22.

G64 Continuous-path Mode

When two or more sequential operations are aligned, the former can be blended with the latter and accelerated/decelerated.

Modal/Non-modal	Modal
Modal group	15 Path Control
Instruction format	G64
Relevant G codes	G01, G02, G03, G500, G501

Parameters

This command does not have any parameters to set.

Function

When G64 is commanded, it is not decelerated to the end point of each block after the command, and cutting is blended with the next block. This command maintains the valid state until G61 is commanded. However, G64 causes the feedrate to be decelerated to 0, and an in-position check is executed in the following cases:

- G00 Rapid Positioning
- G09 Exact Stop
- Block with no movement command in the next block

This does not apply to Multi-block Acceleration/Deceleration Rate Enable (G500).

Refer to *G500, G501 Multi-block Acceleration/Deceleration Rate* on page 2-24 for details.

Programming Example

In the process of a movement command drawing a rectangle, Continuous-path Mode is switched to Exact Stop Mode.

```
N01 G17 G91 G01 ta1000 td1000 ts500 F1000
N02 M03 S1000
N03 G64 // Continuous-path mode
N04 X80
N05 Y40
N06 G61 // Exact stop mode
N07 X-80
N08 Y-40
N09 M30
```

This shows the path of X-Y plane.

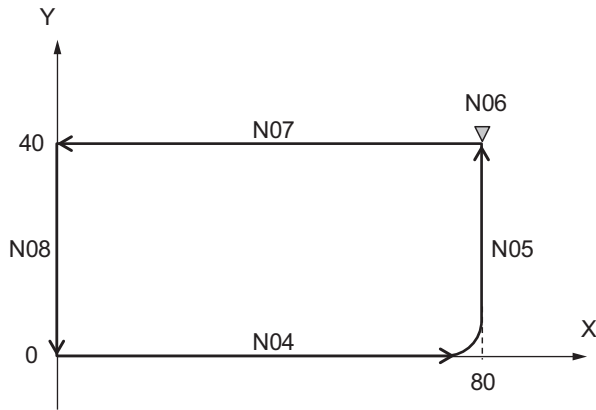

Shows the speed waveforms. The parameters shown in the figure are values $t_a=1000$, $t_d=1000$, and $t_s=500$ that have been specified in the NC program.

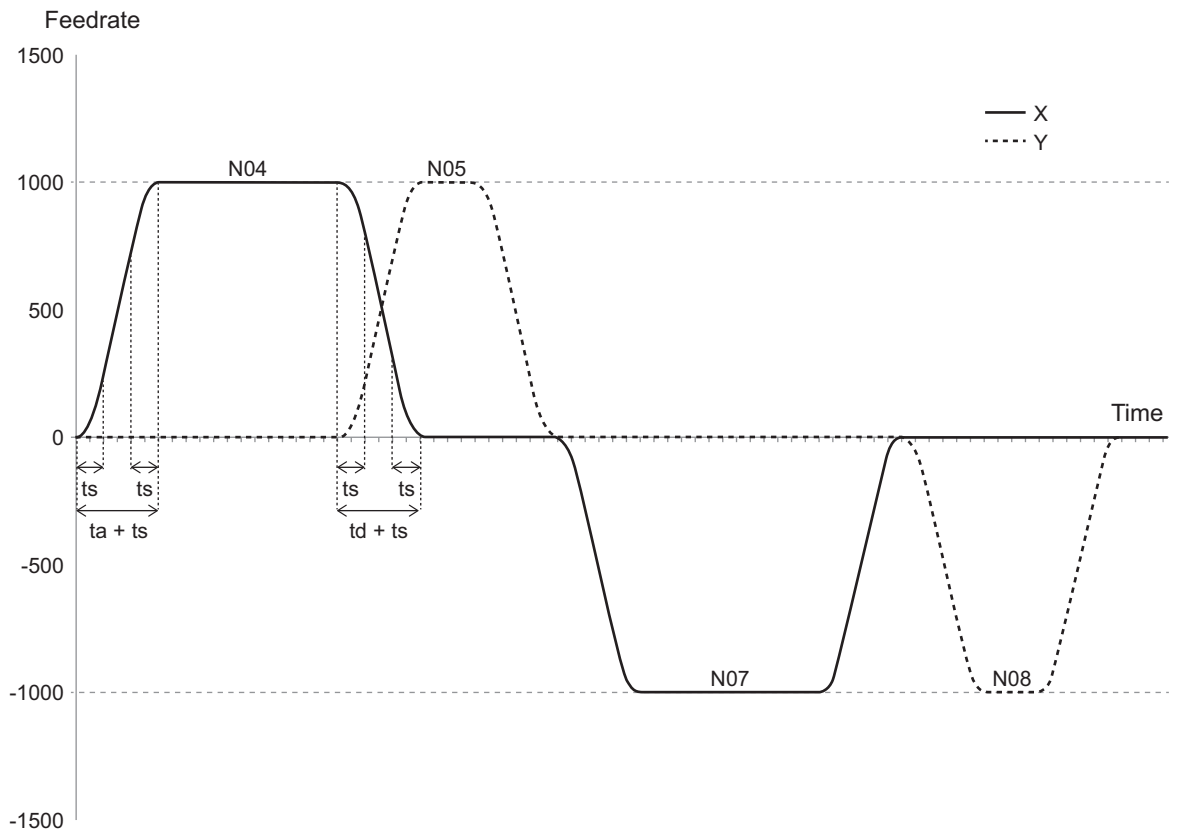

G500, G501 Multi-block Acceleration/Deceleration Rate

Modal/Non-modal	Modal
Modal group	23 Multi-block Acceleration/Deceleration Rate
Instruction format	G500, G501
Relevant G codes	G01, G02, G03, G64

Parameters

This command does not have any parameters to set.

Function

When this command is enabled in Continuous-path Mode, the Controller reads the path ahead and searches for a location where the limitation of position, velocity or acceleration may be exceeded. When the location is found, it decelerates the path to control within the limit range. This change applies retroactively to the path previously calculated, and is completed prior to actual execution.

G500 enables, and G501 disables. G500 must be used simultaneously with Continuous-path Mode (G64). If G500 is used together with the Exact Stop Mode (G61), it operates in the Exact Stop Mode.

If the multi-block acceleration/deceleration rate is disabled, accelerate to the feedrate in the first block, and decelerate in the last block. For this reason, if the specified travel distance is small in acceleration/deceleration operation, the operation is such that the maximum acceleration rate is exceeded.

When the multi-block acceleration/deceleration rate is enabled, accelerate or decelerate to the feedrate across multiple blocks so that the maximum acceleration rate of each motor is not exceeded.

If the multi-block acceleration/deceleration rate is disabled (G501), the following restrictions apply.

- The maximum acceleration or deceleration (CNC motor setting) is made invalid.
- The Back Trace cannot be used.

Programming Example

The following program shows a movement command which draws a line with a series of infinitesimal movements when the multi-block acceleration/deceleration rate is enabled or disabled.

```

N01 G17 G64 G91 G01 F100
N02 M03 S300
N03 G500 // Enables multi-block acceleration/deceleration rate
N04 X1
N05 X1
N06 X1
N07 X1
N08 X1
N09 X1
N10 X1
N11 X1
N12 X1
N13 X1
N14 M05
N15 M30

```

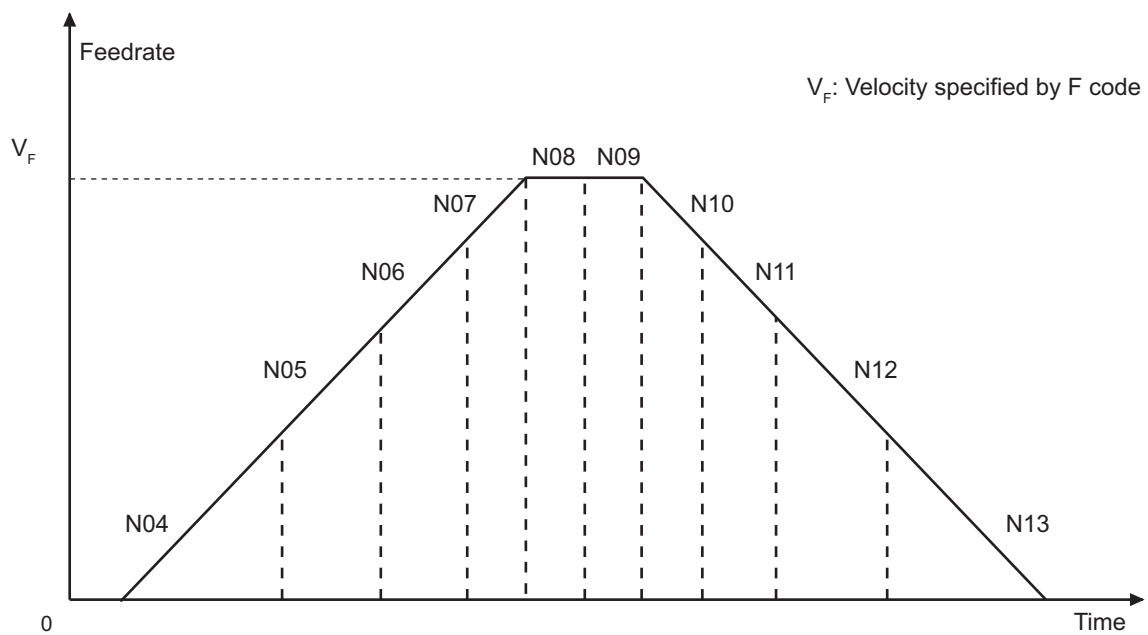

```

N01 G17 G64 G91 G01 F100
N02 M03 S300
N03 G501 // Disables multi-block acceleration/deceleration rate
N04 X1
N05 X1
N06 X1
N07 X1
N08 X1
N09 X1
N10 X1
N11 X1
N12 X1
N13 X1
N14 M05
N15 M30

```

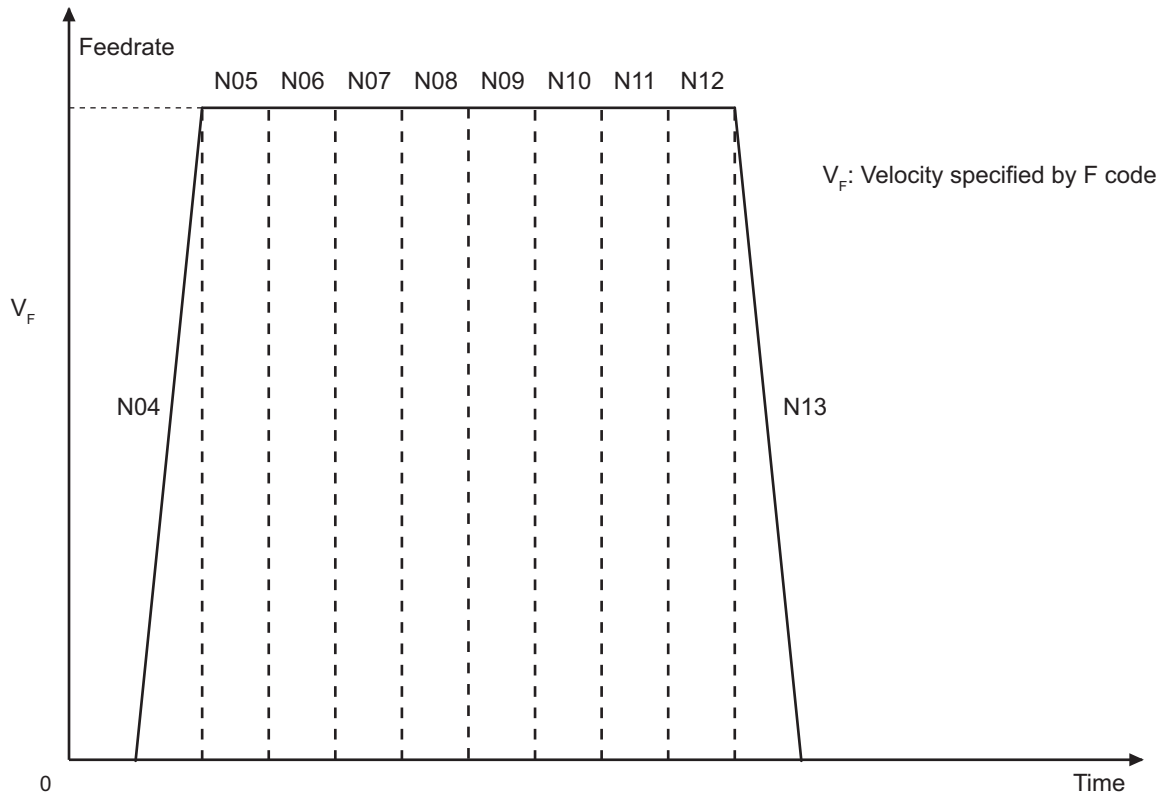

Coordinate System

Instruction	Name	Page
G52	Local Coordinate System Set	P. 2-28
G53	Dimension Shift Cancel	P. 2-29
G54 to G59	Select Work Coordinate System	P. 2-30
G17/G18/G19	Plane Selection	P. 2-31
G20/G21	Inch Input/Metric Input	P. 2-32
G90/G91	Absolute Dimension/Incremental Dimension	P. 2-33

For coordinate system types, refer to the *NJ/NY-series NC Integrated Controller User's Manual* (Cat. No. O030).

G52 Local Coordinate System Set

This instruction creates coordinate system in the Work Coordinate System.

Modal/Non-modal		Non-modal	
Modal group		00 Non-modal	
Instruction format	Local Coordinate System Setting	Set a Local Coordinate System.	G52 X- Y- Z- A- B- C-
		Release a Local Coordinate System.	G52 X0 Y0 Z0 A0 B0 C0
Relevant G codes		G50, G51, G50.1, G51.1, G68, G69, G54 to G59	

Parameters

Parameter	Name	Description
X	X-axis offset	Specifies an X-axis offset [command units] of the coordinate system.
Y	Y-axis offset	Specifies a Y-axis offset [command units] of the coordinate system.
Z	Z-axis offset	Specifies a Z-axis offset [command units] of the coordinate system.
A	A-axis offset	Specifies an A-axis offset [command units] of the coordinate system.
B	B-axis offset	Specifies a B-axis offset [command units] of the coordinate system.
C	C-axis offset	Specifies a C-axis offset [command units] of the coordinate system.

Function

This command adds an offset specified by the parameter to the current coordinate system.

To release the offset, either set it to zero (0) or omit the all axis parameters.

This command releases Scaling (G50/G51), Mirroring (G50.1/G51.1), and Coordinate System Rotation (G68/G69).

G53 Dimension Shift Cancel

This instruction runs commands in the machine coordinate system.

Modal/Non-modal	Non-modal
Modal group	00 Non-modal
Instruction format	G53 X- Y- Z- A- B- C-
Relevant G codes	G50, G51, G50.1, G51.1, G68, G69, G52, G54 to G59, G40, G41, G42, G43, G44, G49

Parameters

Parameter	Name	Description
X	Target X-axis Position	Specifies the destination position [command units] on the X-axis.
Y	Target Y-axis Position	Specifies the destination position [command units] on the Y-axis.
Z	Target Z-axis Position	Specifies the destination position [command units] on the Z-axis.
A	Target A-axis Position	Specifies the destination position [command units] on the A-axis.
B	Target B-axis Position	Specifies the destination position [command units] on the B-axis.
C	Target C-axis Position	Specifies the destination position [command units] on the C-axis.

Function

This command runs rapid positioning commands in the machine coordinates, i.e., coordinates without compensation. The command values are always handled as absolute values, and other movement behaviors follow G00 Rapid Positioning.

This command releases Scaling (G50/G51), Mirroring (G50.1/G51.1), Coordinate System Rotation (G68/G69), and the Local Coordinate System Set (G52). It temporarily releases Zero Shift (G54 to G59) during operation, and maintains the current status of Inch Input/Metric Input (G20/G21). Tool Offset (G43/G44/G49) and Cutter Compensation (G40/G41/G42) must be released prior to execution of this command.

G54 to G59 Select Work Coordinate System

These instructions change the current Work Coordinate System.

Modal/Non-modal		Modal
Modal group		14 Coordinate System Selection
Instruction format	1st work coordinate system	G54
	2nd work coordinate system	G55
	3rd work coordinate system	G56
	4th work coordinate system	G57
	5th work coordinate system	G58
	6th work coordinate system	G59
Relevant G codes		G50, G51, G50.1, G51.1, G53, G68, G69

Parameters

This command does not have any parameters to set.

Function

Changes the current coordinate system to a specified one defined by the user by using the offsets of X-, Y-, Z-, A-, B-, and C-axis.

This command releases Scaling (G50/G51), Mirroring (G50.1/G51.1), and Coordinate System Rotation (G68/G69).

For offset settings of work coordinate system, refer to the *Work Coordinate System Offset Parameters of NJ/NY-series NC Controller User's Manual* (Cat. No. O030).

G17, G18, G19 Plane Selection

These instructions select a plane to be the basis of instructions.

Modal/Non-modal		Modal
Modal group		02 Plane
Instruction format	X-Y Plane	G17
	Z-X Plane	G18
	Y-Z Plane	G19
Relevant G codes		G02, G03, G41, G42, G68, G69

Parameters

This command does not have any parameters to set.

Function

This command selects a plane, the reference of Circular Interpolation (G02/G03), Cutter Compensation (G40/G41/G42), and Coordinate System Rotation (G68/G69). You can specify XY (G17), ZX (G18), and YZ (G19). XY is specified at startup. Refer to *G02, G03 Circular Interpolation* on page 2-8, *G40, G41, G42 Cutter Compensation* on page 2-40, *G68, G69 Coordinate System Rotation* on page 2-57 for details.

Precaution for Usage

Depending on plane selection of G17/G18/G19, some G codes change operation while others do not change operation. The following shows operations changed according to plane selection.

- G41/G42 (Cutter Compensation): The cutter radius is compensated for the selected plane. An error will occur if planes are switched during cutter compensation.
- G43/G44 (Tool Offset): The tool length is compensated for Z-axis regardless of the selected plane. No error will occur even if planes are switched during tool offset.
- G74/84 (Fixed Cycle): During a fixed cycle, the cutting is executed in the Z-axis direction regardless of the selected plane.

Refer to the following table for the relationship between plane selection and each G code.

G Code	G41/G42 (Cutter Compensation)	G43/G44 (Tool Offset)	G74/84 (Fixed Cycle)
G17 (XY Plane Selection)	The cutter radius is compensated for the XY plane.	The tool length is compensated in the Z-axis direction.	Fixed cycle operation is fixed to the Z-axis direction.
G18 (ZX Plane Selection)	The cutter radius is compensated for the ZX plane.		
G19 (YZ Plane Selection)	The cutter radius is compensated for the YZ plane.		

G20 Inch Input, G21 Metric Input

These instructions toggle the units.

Modal/Non-modal		Modal
Modal group		06 Unit
Instruction format	Inch input	G20
	Metric input	G21
Relevant G codes		---

Parameters

This command does not have any parameters to set.

Function

Switches all the settings of the CNC coordinate system, command values, and the unit of current values. You can select “inch” or “mm” for the unit. For example, for the maximum velocity of a CNC coordinate system, only the interpretation of the unit system can be changed without changing values.

G90 Absolute Dimension, G91 Incremental Dimension

These instructions set a feed command to the Absolute Dimension or Incremental Dimension command.

Modal/Non-modal		Modal
Modal group		03 Distance
Instruction format	Absolute command	G90
	Incremental command	G91
Relevant G codes		G00, G01, G02, G03, G28, G30, G31, G74, G84, G50, G51, G50.1, G51.1, G68, G69

Parameters

This command does not have any parameters to set.

Function

Absolute position mode and Incremental position mode is provided for operating functions. Executing G90 enables absolute position mode for all axes in the CNC coordinate system, and moves the axes to a specified position in the current coordinate system. Executing G91 enables Incremental position mode for all axes in the CNC coordinate system, and moves the axes a certain distance from the last command position. By default, absolute position mode is enabled for all axes.

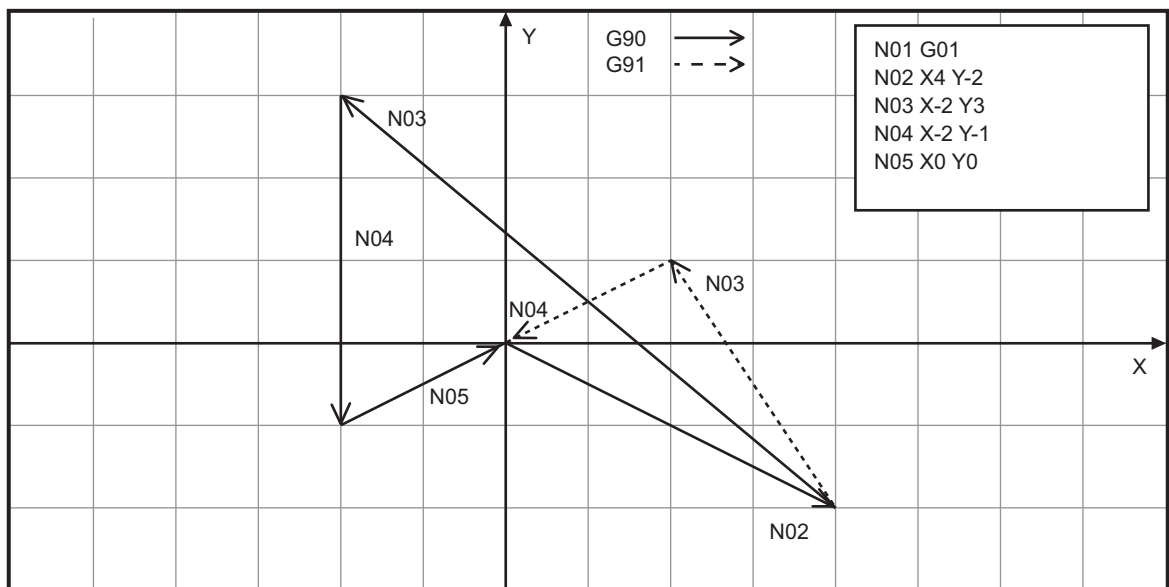

Reference Point

Instruction	Name	Page
G28	Return to Reference Point	P. 2-36
G30	Return to 2nd, 3rd and 4th Reference Point	P. 2-38

G28 Return to Reference Point

This instruction returns the tool automatically to the reference point via the specified middle point.

Modal/Non-modal	Non-modal
Modal group	00 Non-modal
Instruction format	G28 X- Y- Z- A- B- C-
Relevant G codes	G90, G91, G50, G51, G50.1, G51.1, G68, G69, G54 to G59, G40, G41, G42, G43, G44, G49

Parameters

Parameter	Name	Description
X	X-axis middle point	Specifies a middle point [command units] on the X-axis.
Y	Y-axis middle point	Specifies a middle point [command units] on the Y-axis.
Z	Z-axis middle point	Specifies a middle point [command units] on the Z-axis.
A	A-axis middle point	Specifies a middle point [command units] on the A-axis.
B	B-axis middle point	Specifies a middle point [command units] on the B-axis.
C	C-axis middle point	Specifies a middle point [command units] on the C-axis.

Function

The G28 command moves the tool to the optional middle point at rapid feed, then returns it to the reference point. If the middle point is not specified, the tool returns directly to the reference point.

- The tool is moved to the reference point (position 0) via the middle point.
- The middle point follows the specifications for the Absolute Dimension (G90) and Incremental Dimension (G91).
- The only axis that operates is the one for which the middle point is specified.
- Motion to each point follows the Rapid Positioning (G00) specifications.
- After the middle point is reached, this command releases Scaling (G50/G51), Mirroring (G50.1/G51.1), and Coordinate System Rotation (G68/G69). During motion between the middle point and reference point, this command also releases Zero Shift (G54 to G59) temporarily. It maintains the current status of Inch Input (G20) and Metric Input (G21). Tool Offset (G43/G44/G49) and Cutter Compensation (G40/G41/G42) must be released prior to execution of this command.

Programming Example

After cutting operation, the tool moves to the middle position (10, 10) and returns to the reference point (0, 0).

```

N01 G17 G91 G64 F1000
N02 M03 S500
N03 G00 X10 Y20
N04 G01 X40
N05 Y10
N06 X-40
N07 Y-10
N08 G28 X0 Y-10           // Return to reference point
N09 M30

```

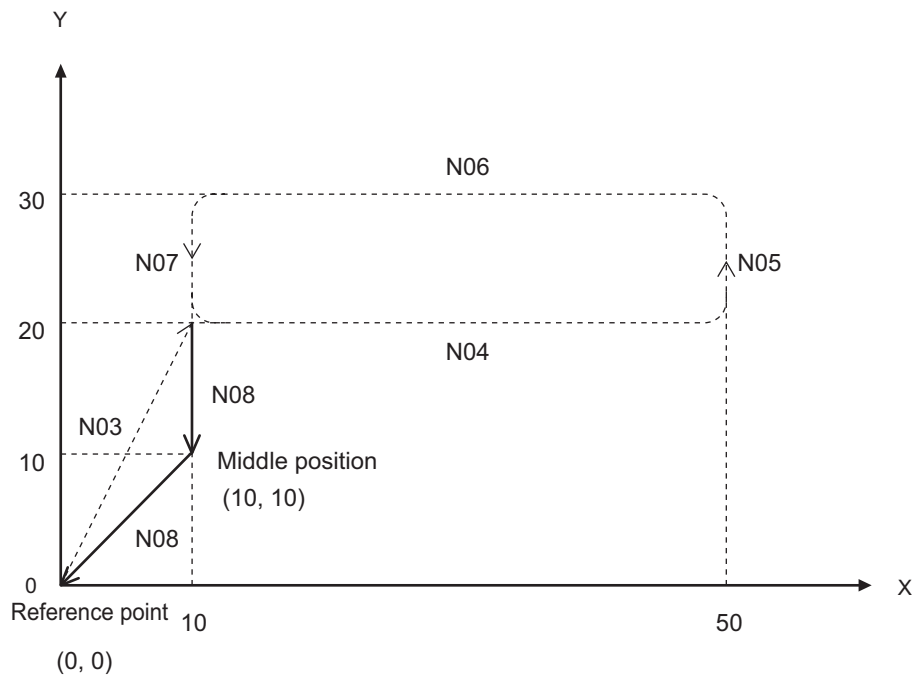

G30 Return to 2nd, 3rd and 4th Reference Point

This instruction returns the tool to the 2nd, 3rd, or 4th reference point.

Modal/Non-modal		Non-modal	
Modal group		00 Non-modal	
Instruction format	Return to 2nd, 3rd or 4th Reference Point	Return to 2nd Reference Point	G30 X- Y- Z- A- B- C-
		Return to 2nd Reference Point	G30 P2 X- Y- Z- A- B- C-
		Return to 3rd Reference Point	G30 P3 X- Y- Z- A- B- C-
		Return to 4th Reference Point	G30 P4 X- Y- Z- A- B- C-
Relevant G codes		G90, G91, G50, G51, G50.1, G51.1, G68, G69, G54 to G59, G40, G41, G42, G43, G44, G49	

Parameters

Parameter	Name	Description
X	X-axis middle point	Specifies a middle point [command units] on the X-axis.
Y	Y-axis middle point	Specifies a middle point [command units] on the Y-axis.
Z	Z-axis middle point	Specifies a middle point [command units] on the Z-axis.
A	A-axis middle point	Specifies a middle point [command units] on the A-axis.
B	B-axis middle point	Specifies a middle point [command units] on the B-axis.
C	C-axis middle point	Specifies a middle point [command units] on the C-axis.
P	Reference point setting	Reference point

Function

This command moves the tool to the 2nd, 3rd, or 4th reference point. The reference points follows the settings. The reference points are identified by the P word. The operation for this command is the same as that for the Return to Reference Point (G28).

Compensation Functions

Instruction	Name	Page
G40/G41/G42	Cutter Compensation	P. 2-40
G43/G44/G49	Tool Offset	P. 2-51
G50/G51	Scaling	P. 2-53
G50.1/G51.1	Mirroring	P. 2-55
G68/G69	Coordinate System Rotation	P. 2-57

G40, G41, G42 Cutter Compensation

These instructions compensate the path by considering the tool diameter.

Modal/Non-modal		Modal
Modal group		07 Tool radius
Instruction format	Cancels tool compensation	G40
	Tool Compensation, left	G41
	Tool Compensation, right	G42
Relevant G codes		G01, G02, G03, G17, G18, G19

Parameters

This command does not have any parameters to set.

Function

This command assumes the correction of cylindrical tool radius orthogonal to a plane. The correction offset adapts automatically to two axes vertical to the plane, and the corrected path shifts from the commanded path by the tool radius.

This command acts on G01, G02, and G03. The user can select XY, YZ, or ZX plane with Plane Selection (G17/G18/G19).

G40 is Cutter Compensation Cancel, G41 is Cutter Compensation Left, and G42 is Cutter Compensation Right.

The compensation cannot be started with Circular Interpolation (G02/G03).

The travel distance at startup must be greater than the cutter radius. However, when the tool moves inside the arc, the cutter radius must be smaller than the circular command.

The extent of correction depends on the selected tool.

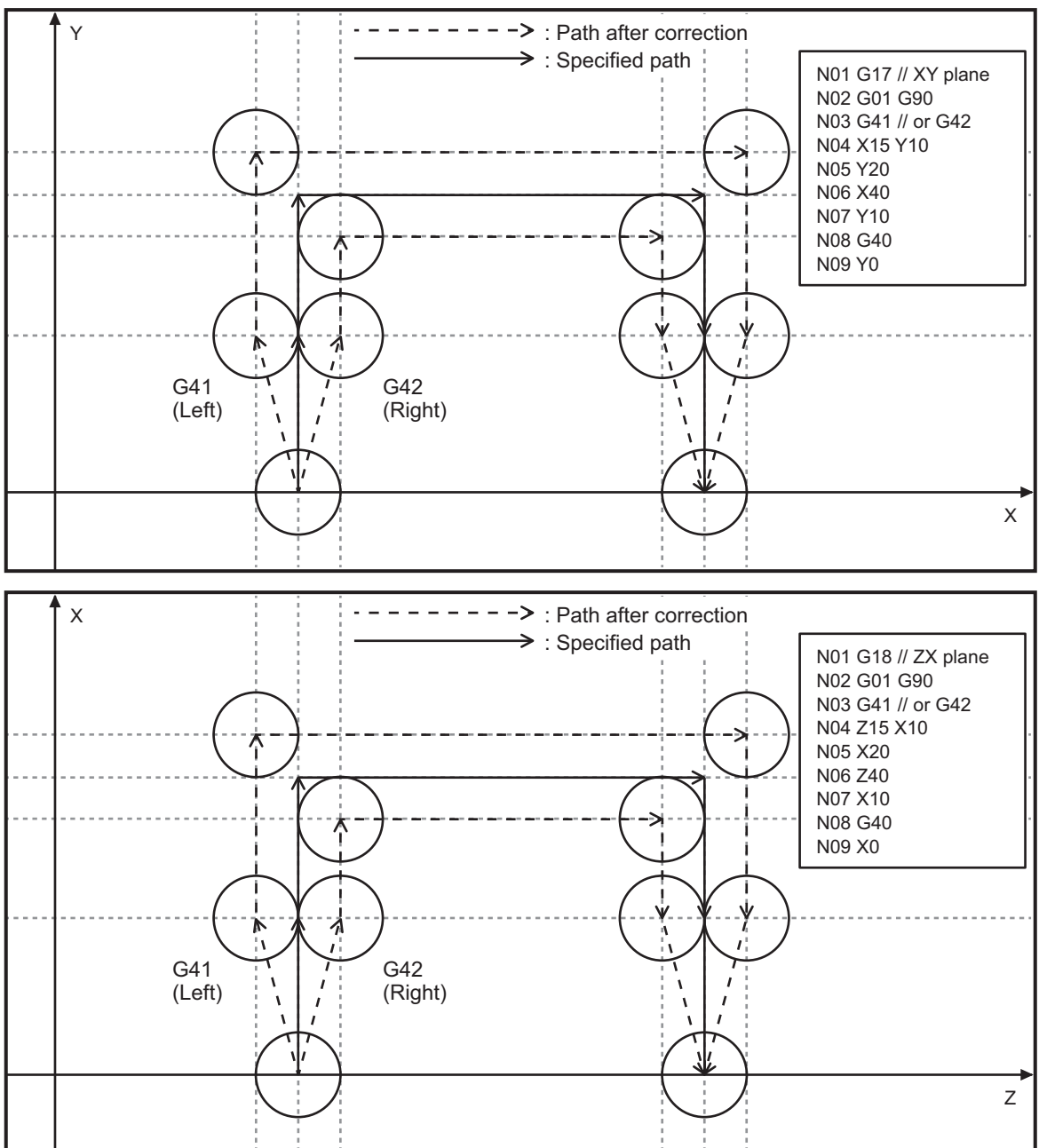

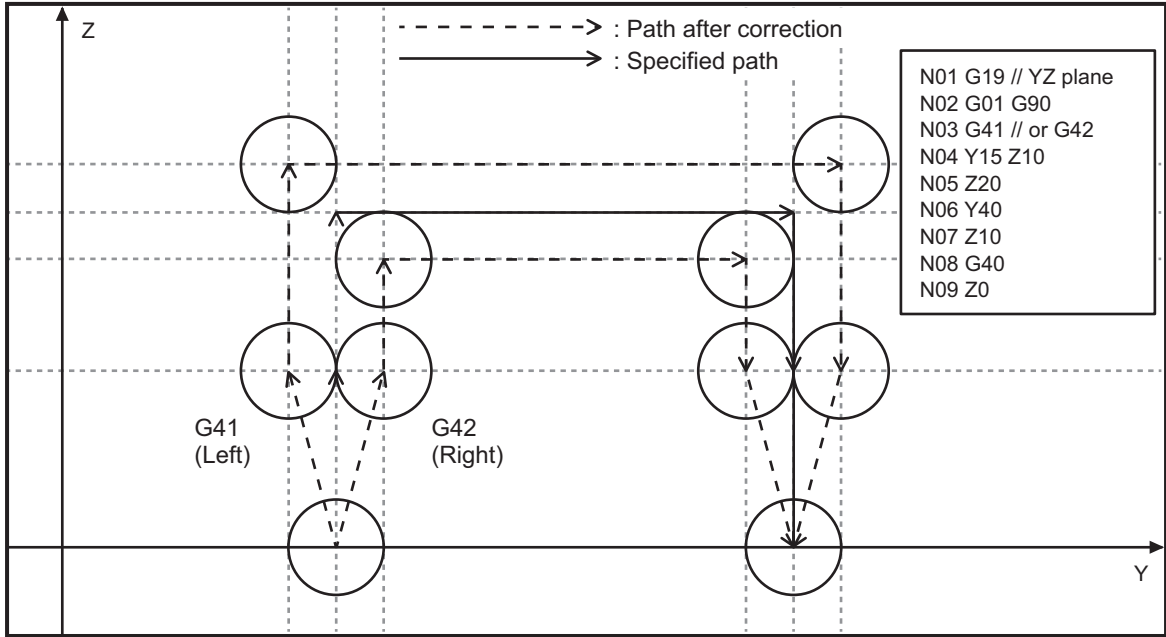

Compensated circular speed

When Circular Interpolation (G02/G03) is used simultaneously with G40, G41, or G42, the path of the tool center differs from the commanded path that applies to the tool edge. This makes the velocity different between the tool center and the commanded path.

The user can select the tool center path after correction or the tool edge path contacting with the command to move the tool at the specified velocity.

Tool diameter compensation: Corner circular interpolation (Added Arc)

When the angle of a corner exceeds 270 degrees, this command automatically adds an arc with the same radius as the cutter radius.

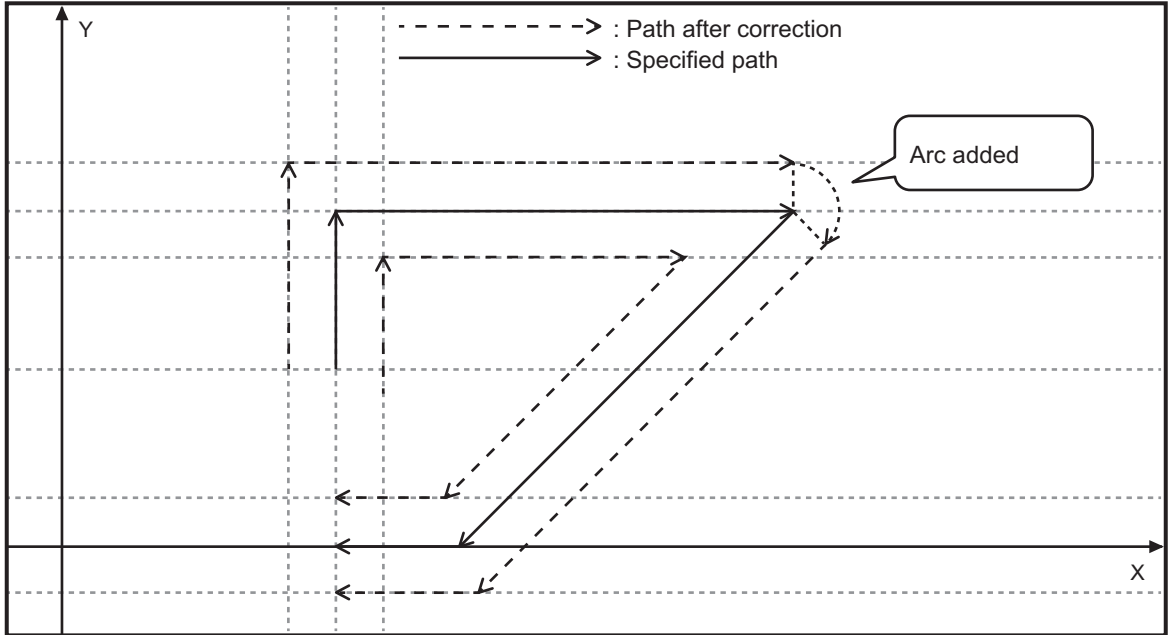

Start of Correction at Inside the Corner

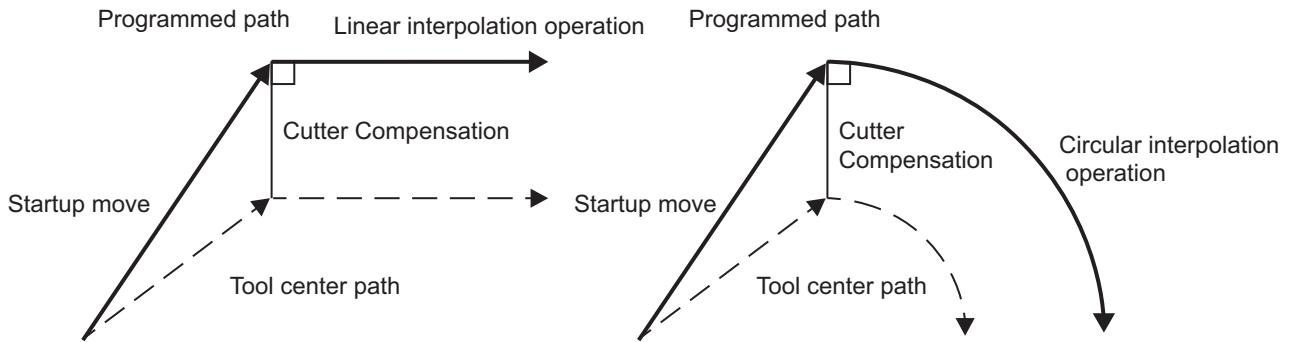

Start of Correction at Outside the Corner

- No arc is added

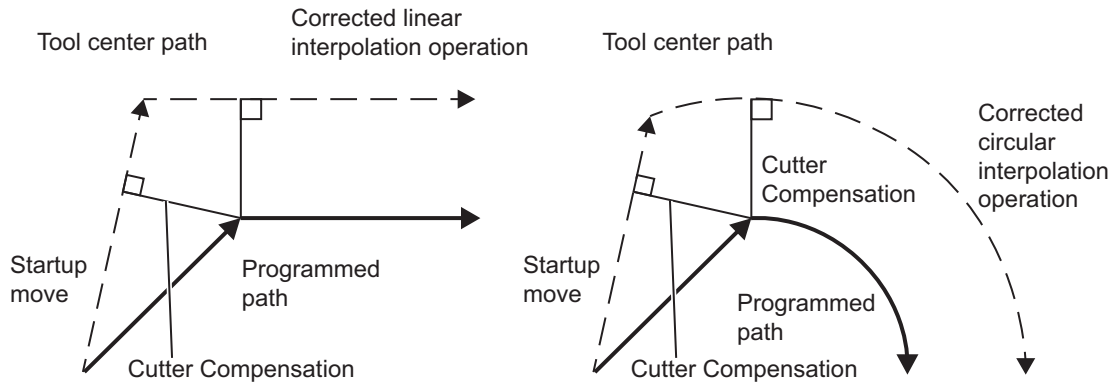

- An arc is added

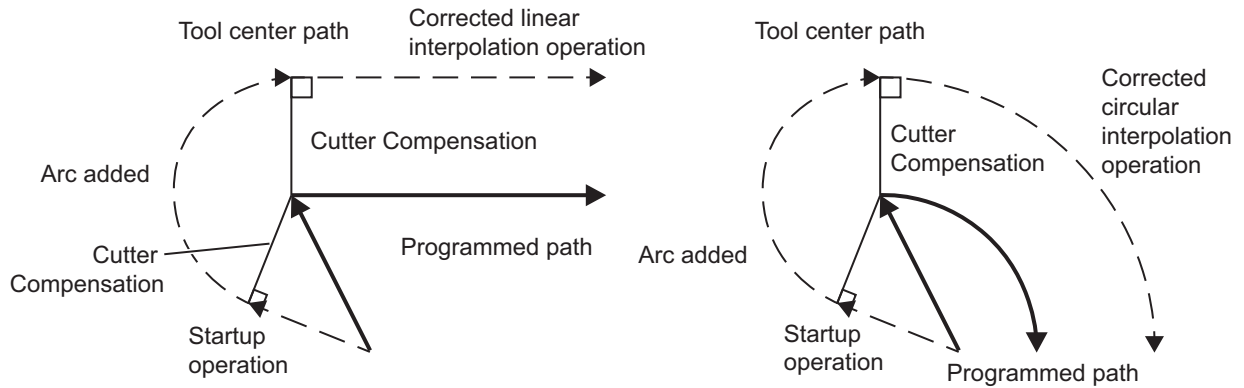

Correction processing at Inside the Corner

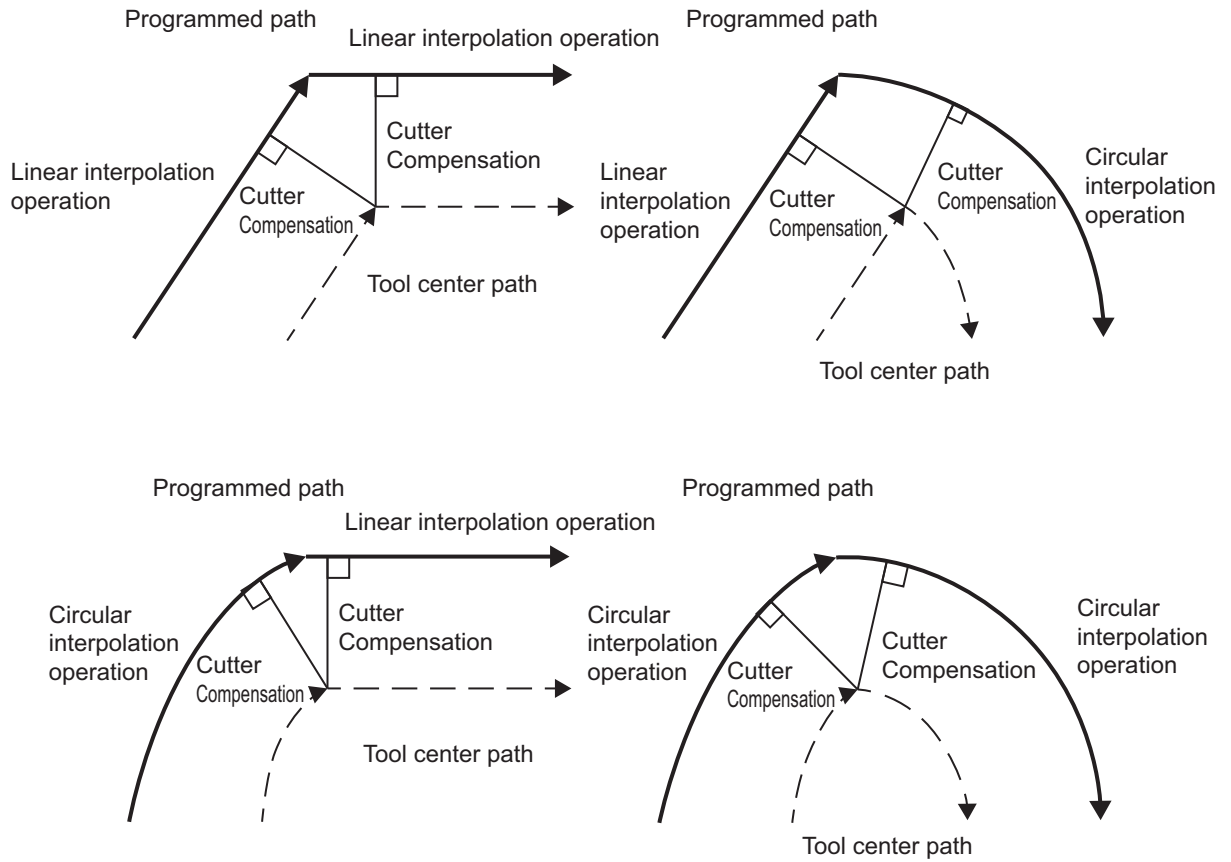

Correction processing at Outside the Corner

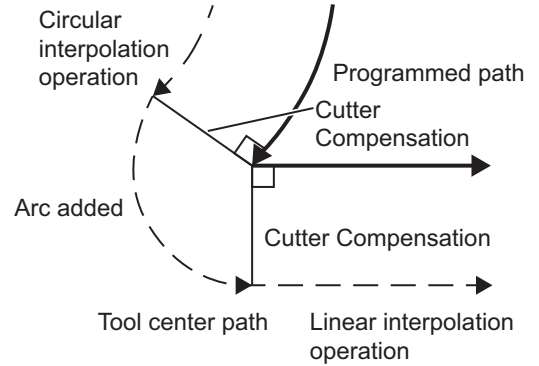
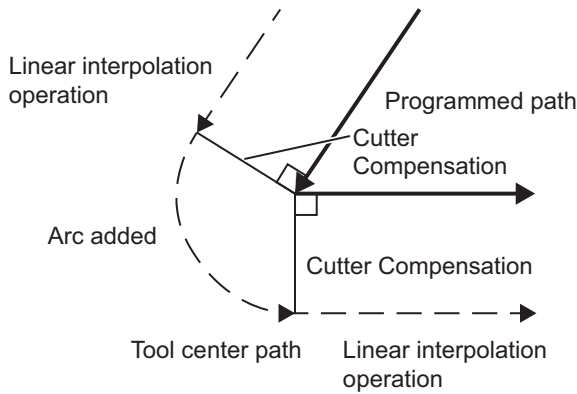

● Cutter radius correction of outside corner with a deep angle

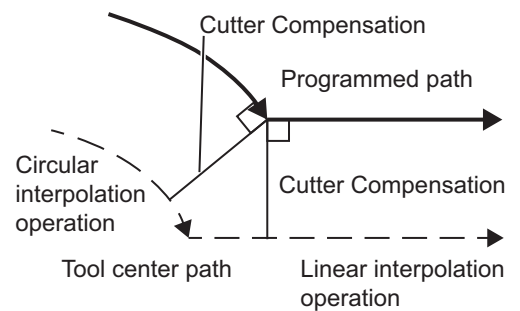
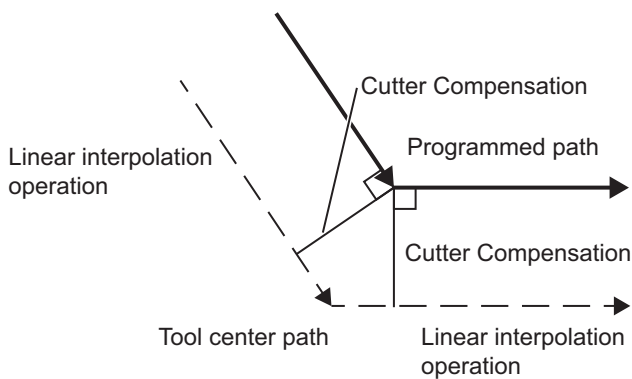
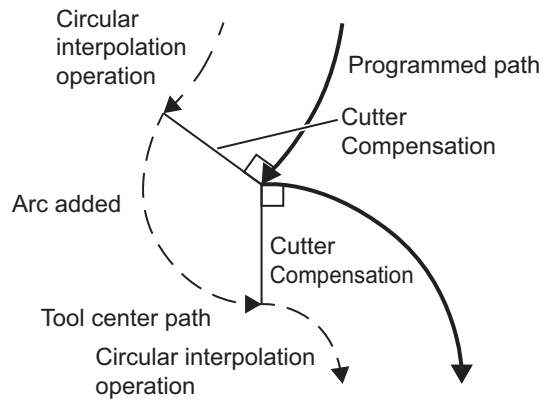
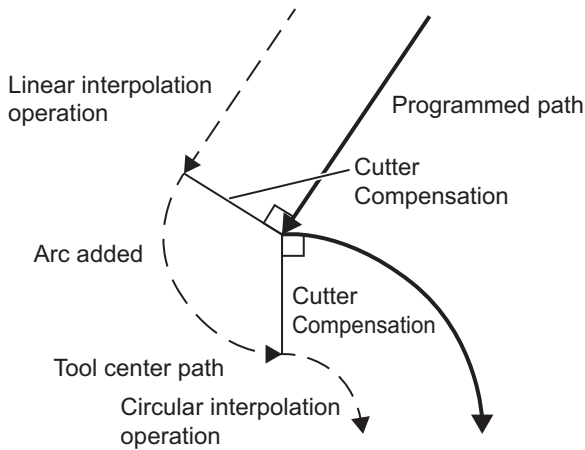

● **Cutter radius correction of outside corner with a shallow angle**

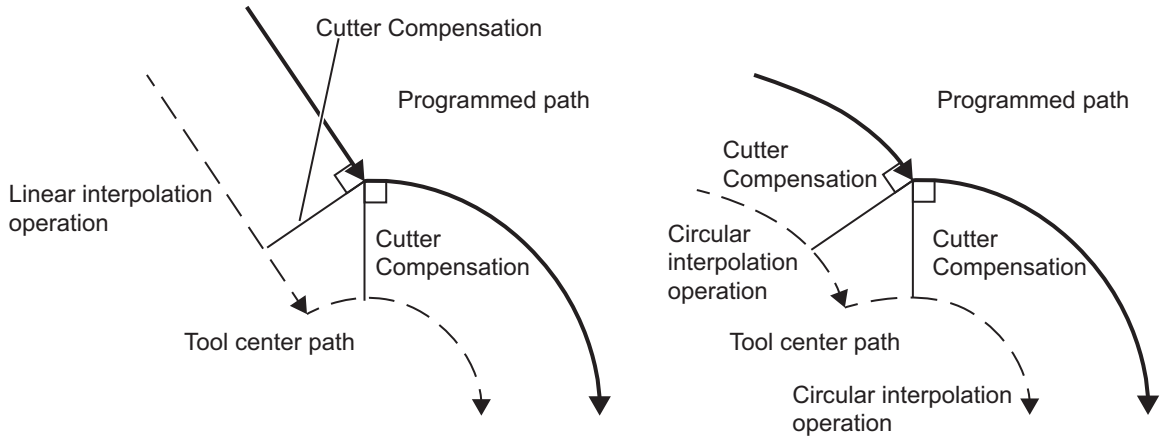

Termination of Correction at Inside the Corner

● **Cancellation of cutter radius correction at inside the corner**

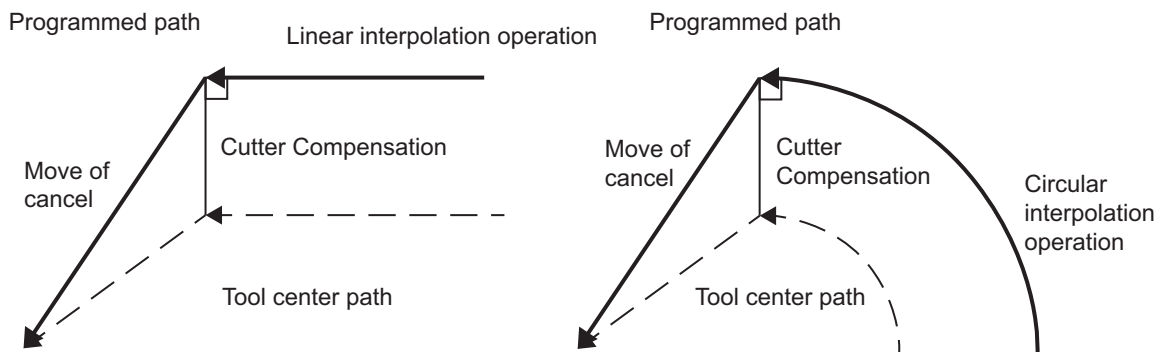

Termination of Correction at Outside the Corner

● **No arc is added**

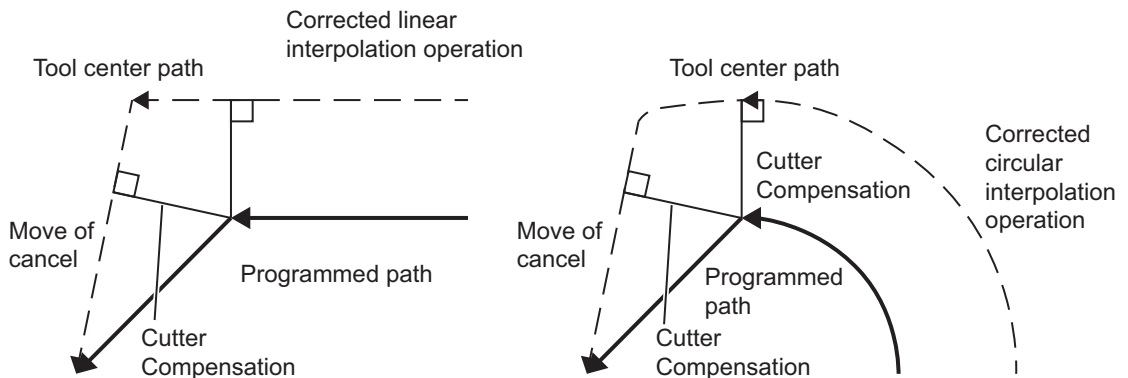

● An arc is added

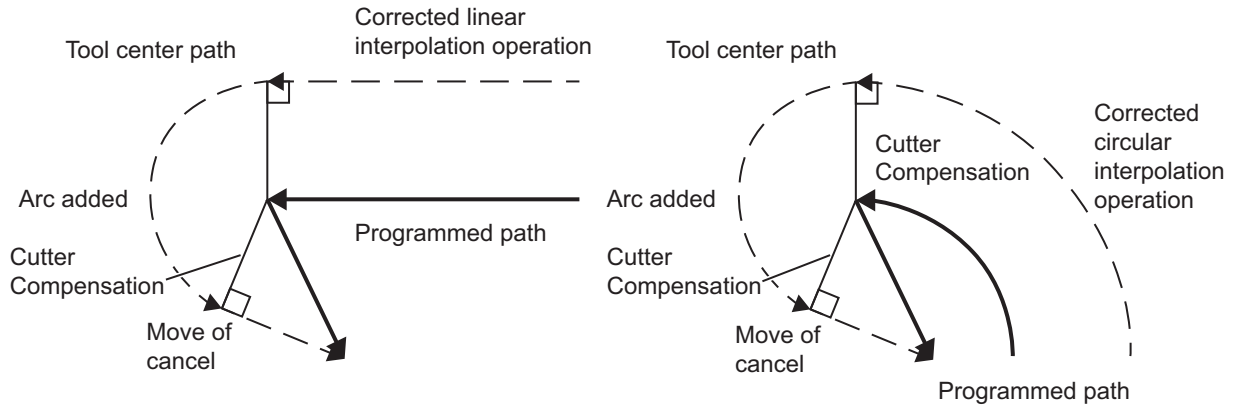

Detection of Overcut

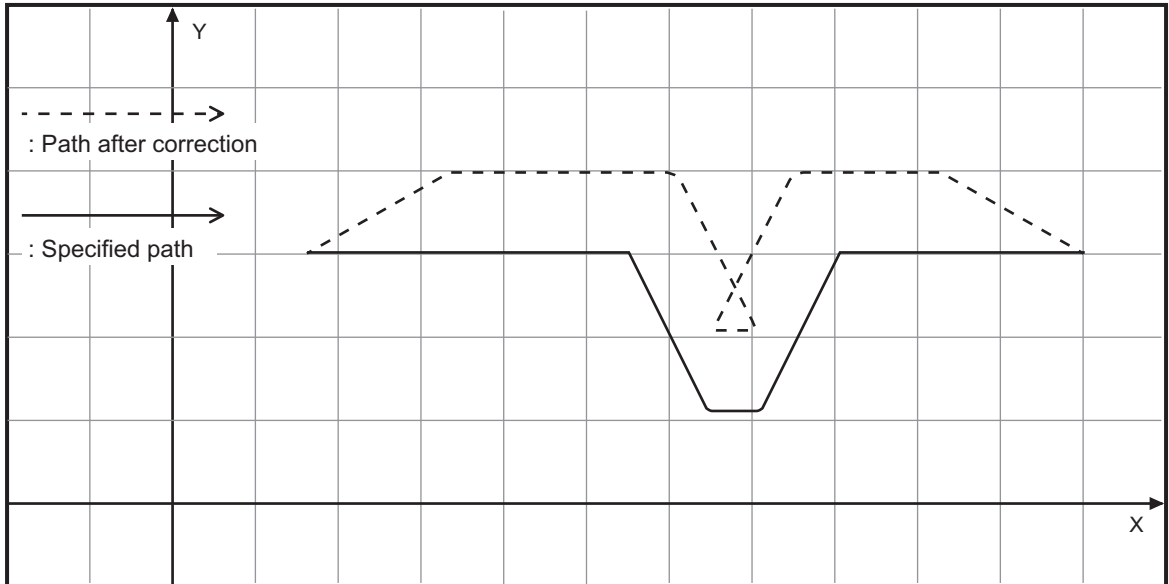

When an overcut is detected, the operation stops and an error occurs.

To detect an overcut, set the Overcut operation mode to Overcut detection. For details, refer to the *NJ/NY-series NC Integrated Controller User's Manual (Cat. No. O030)*.

Prevention of Overcut

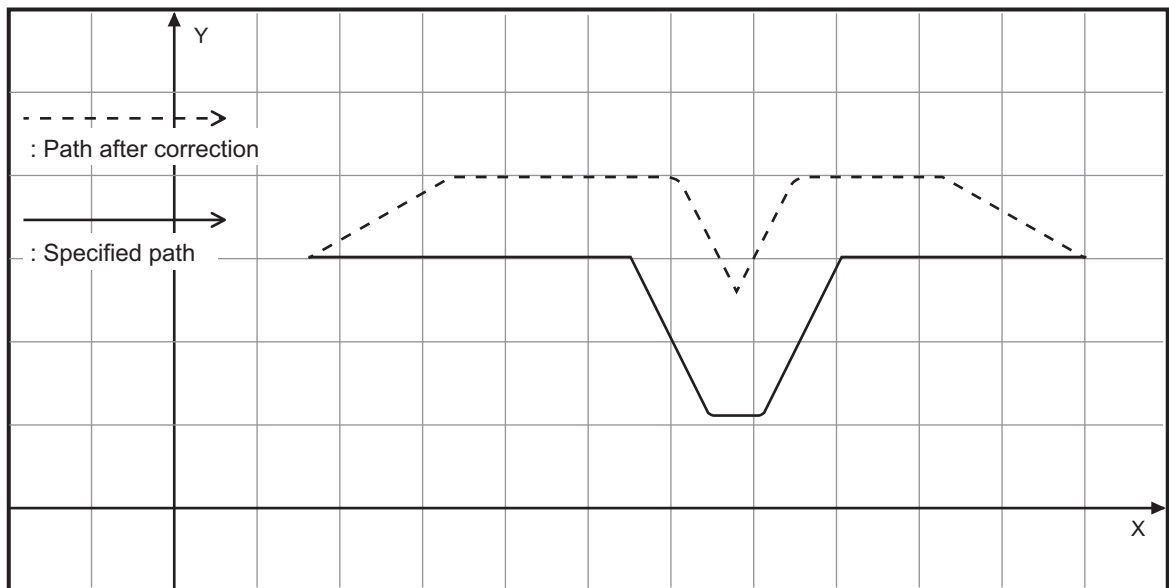

When an overcut is detected, some operations are skipped to prevent the overcut. If the tool passes the inside of an arc that is smaller than the tool, the error cannot be prevented. The user needs to use a tool smaller than the arc, or change the arc that causes the error to a straight line.

To prevent an over-cut, set the Over-cut operation mode to Prevention of over-cuts. For details, refer to the *NJ/NY-series NC Integrated Controller User's Manual* (Cat. No. O030).

Programming Example

The following program executes a series of operations from the start to the end of cutter compensation. The operations consist of the following three steps.

1. Startup operation: Movement to the cutting surface with the first operation command that enabled the cutter compensation by G41/42.
2. Correction operation: Cutting with operation commands between the startup operation and cancel operation.
3. Cancel operation: Leaving from the cutting surface with the first operation command that disabled the cutter compensation by G40.

```

N01 G500 G17 G64 G91 G01 F100
N02 M100 VA1 // Tool change Tool ID #1 (Cutter radius: 5)
N03 S300 M03
N04 G41 // Enables cutter compensation
N05 X10 // Startup operation
N06 X10 // Correction operation
N07 G40 // Disables cutter compensation
N08 X10 Y0 Z0 // Cancel operation
N09 M30

```

Use of M100 for transferring the tool change request to the sequence control program is an example. When using this command, refer to the instruction manual provided by the machine tool manufacturer.

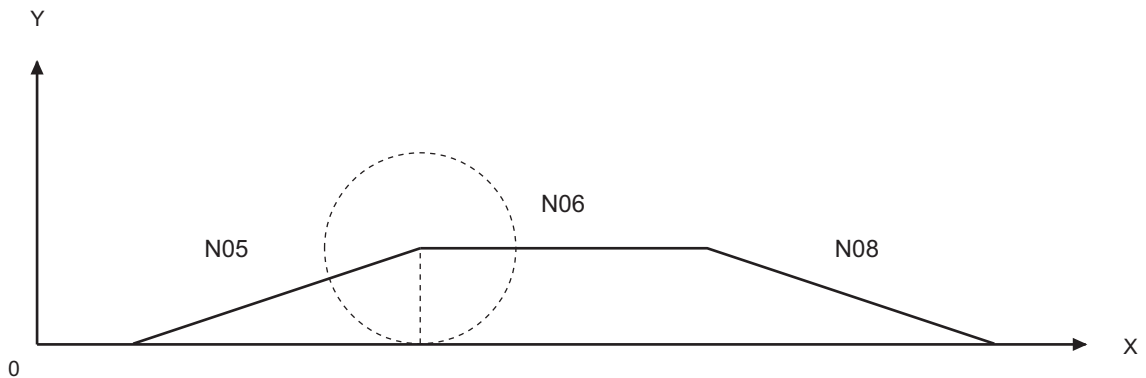

Cutter Compensation of G41/G42 has the following restrictions for operation during correction.

- A series of operations such as the startup operation, correction operation, and cancel operation must be provided.
- The modal that can be used during the correction operation is G01/02/03.
- G02/03 cannot be used for the startup operation and cancel operation.
- G00 cannot be used for the startup operation.
- The travel distance of the startup operation and the cancel operation must be equal to or greater than the cutter radius.
- Edge surfaces cannot be switched (between G41 and G42) during the correction operation. For the operation that the tool intersects the edge surface, cancel it once with G40 before switching edge surfaces.
- During tool compensation, M code for which the M code output timing (M code setting) is Synchronous, or M code for which parameters are specified cannot be used. For the M code output timing, refer to the *NJ/NY-series NC Integrated Controller User's Manual* (Cat. No. O030).
- During correction operation, a single block execution or the program stop by M00/M01 is not allowed.

G43, G44, G49 Tool Offset

These instructions compensate the path by considering the tool length.

Modal/Non-modal		Modal
Modal group		08 Tool length offset
Instruction format	Tool length correction, in positive direction	G43
	Tool length correction, in negative direction	G44
	 Cancels tool offset	G49
Relevant G codes		G01, G02, G03, G17, G18, G19

Parameters

This command does not have any parameters to set.

Function

This command immediately corrects the position in the Z-axis direction. G43 corrects the position in the positive direction, G44 in the negative direction, and G49 terminates the correction. The extent of correction depends on the selected tool.

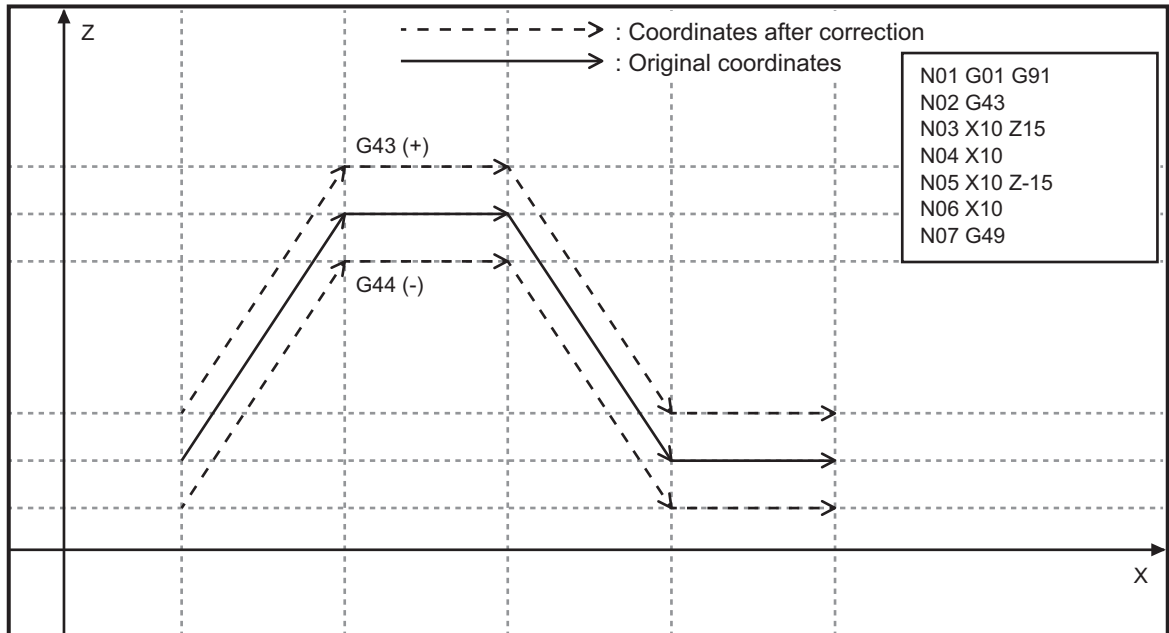

Programming Example

The following program executes a series of operations from the start to the end of tool offsetting. This sample programming shows the change of tool length during the cutting operation.

```

N01 G17 G64 G90 G01 F100
N02 M100 VA1 // Tool change Tool ID #1 (Tool length: 8)
N03 G43 // Enables tool offset
N04 X10 Z-10
N05 X20
N06 M100 VA2 // Tool change Tool ID #2 (Tool length: 6)
N07 G43 // Enables tool offset
N08 X30 Z-10
N09 X40
N10 G49 // Disables tool offset
N11 X50 Z0 // Cancels tool offset
N12 M30

```

Use of M100 for transferring the tool change request to the sequence control program is an example. When using this command, refer to the instruction manual provided by the machine tool manufacturer.

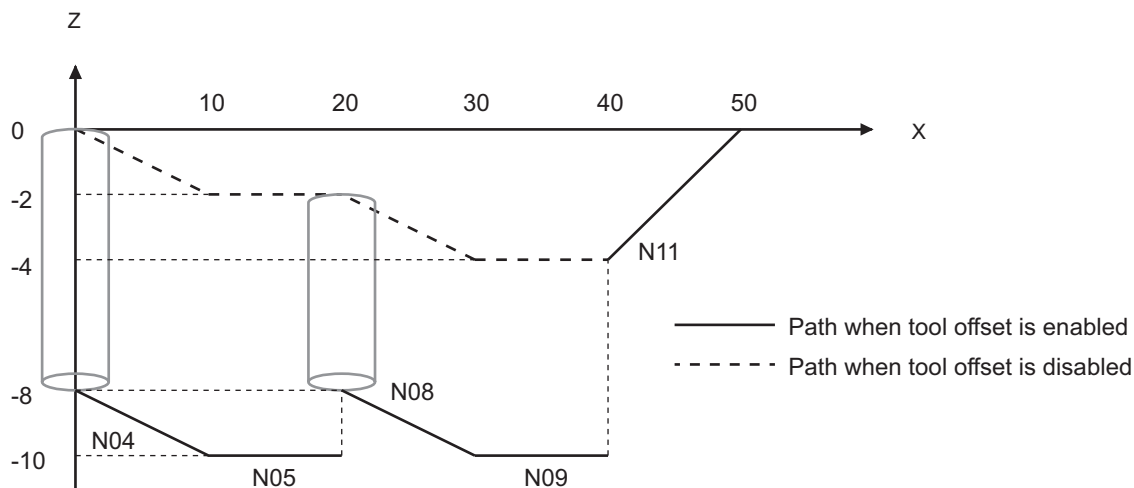

G50, G51 Scaling

These instructions magnifies or compresses a commanded shape.

Modal/Non-modal		Modal	
Modal group		11 Scaling	
Instruction format	Disables scaling	G50	
	Enables scaling	When specifying the X, Y and Z-axis scales simultaneously	G51 X- Y- Z- P-
		When specifying the X, Y and Z-axis scales separately	G51 X- Y- Z- I- J- K-
Relevant G codes		G00, G01, G02, G03, G90, G91	

Parameters

Parameter	Name	Description
X	X-axis center point	Specifies a center point [command units] on the X-axis.
Y	Y-axis center point	Specifies a center point [command units] on the Y-axis.
Z	Z-axis center point	Specifies a center point [command units] on the Z-axis.
I	X-axis scaling magnification	Specifies an X-axis magnification ratio.
J	Y-axis scaling magnification	Specifies a Y-axis magnification ratio.
K	Z-axis scaling magnification	Specifies a Z-axis magnification ratio.
P	Scaling ratio of all axes	Specifies a magnification ratio of all axes.

Function

The G50 and G51 scale the current coordinate system. G50 disables the scaling and G51 enables it. X, Y, and Z parameters indicate the center point. If any of them is omitted, the omitted value is handled as the current position. The values of X, Y, and Z parameters are handled as absolute position. The P parameter indicates the magnification ratio of all of the X-, Y-, and Z-axis, whereas I, J, or K parameter is the magnification ratio of each axis. The I, J, and K parameters are the magnification ratio of X-, Y-, and Z-axis respectively. If any of I, J, and K parameters is omitted, the omitted value is handled as the same size. P parameter is prioritized over I, J, and K parameters.

Programming Example

The following program enlarges the circle defined in the subprogram to double size.

```

N11 G64 G90 G01 F100
N12 M03 S300
N13 G51 X20 Y15 P2           // Sets scaling to double.
N14 M98 P1000                // Cuts the figure of double size (indicated by the solid
                             // line in the following figure).
N15 G50                       // Disables scaling
N16 G01 X0 Y0
N17 M98 P1000                // Cuts the figure of original size (indicated by the
                             // broken line in the following figure).

N18 M05
N19 M30

// Subprogram drawing a circle
// NC Program No.1000
N01 G17 G01 X20 Y10
N02 G02 X20 Y20 R5
N03 G02 X20 Y10 R5
N04 M99                       // End of the subprogram

```

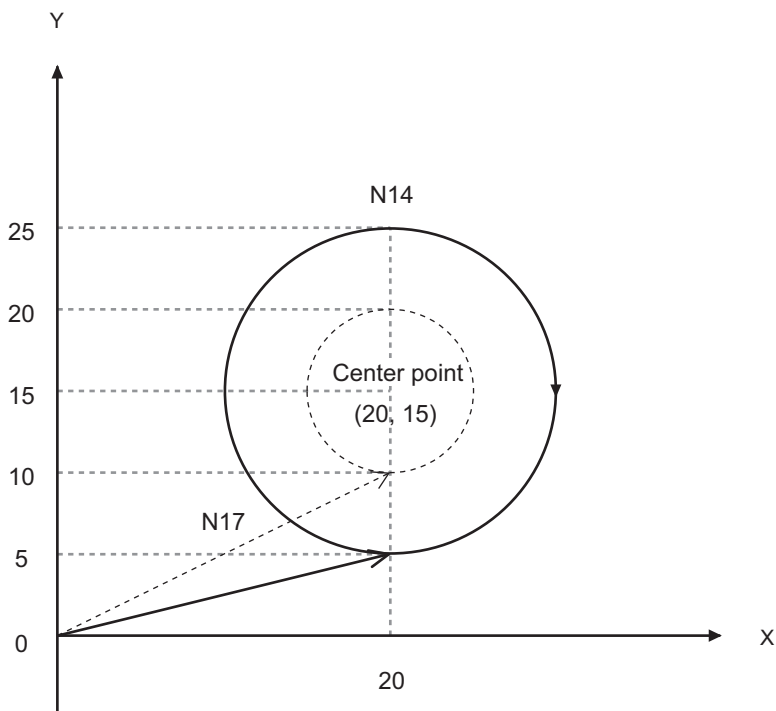

G50.1, G51.1 Mirroring

These instructions invert the path on the specified coordinate system.

Modal/Non-modal		Modal
Modal group		22 Mirroring
Instruction format	Disables mirroring	G50.1
	Enables mirroring	G51.1 X- Y- Z-
Relevant G codes		G00, G01, G02, G03, G17, G18, G19

Parameters

Parameter	Name	Description
X	X-axis center point	Specifies a center point [command units] on the X-axis.
Y	Y-axis center point	Specifies a center point [command units] on the Y-axis.
Z	Z-axis center point	Specifies a center point [command units] on the Z-axis.

Function

The G50.1 and G51.1 mirror the current coordinates. G50.1 disables mirroring, and releases the mirroring of symmetric axes specified by X, Y, and Z parameters in the instruction format. G51.1 enables mirroring. In the instruction format, X, Y, and Z parameters indicate the symmetric axes. If any of them is omitted, the axis is not mirrored. The values of X, Y, and Z parameters are handled as absolute positions.

Programming Example

The following program reverses a figure defined in the subprogram across the symmetric axes.

```

N11 G64 G90 G01 F100
N12 M03 S300
N13 G51.1 X30           // Line symmetry to X=30
N14 M98 P1000          // Cuts the mirrored figure by calling the subprogram
                        // (indicated by the solid line in the following figure).

N15 G50.1
N16 G01 X0 Y0
N17 M98 P1000          // Cuts the original figure by calling the subprogram
                        // (indicated by the broken line in the following figure).

N18 M05
N19 M30

// Subprogram drawing a figure
// NC Program No.1000
N01 G17 G01 X10 Y10
N02 G01 X20 Y10
N03 G01 X20 Y30
N04 G01 X15 Y30
N05 G03 X10 Y25 R5
N06 G01 X10 Y10
N07 M99                // End of the subprogram

```

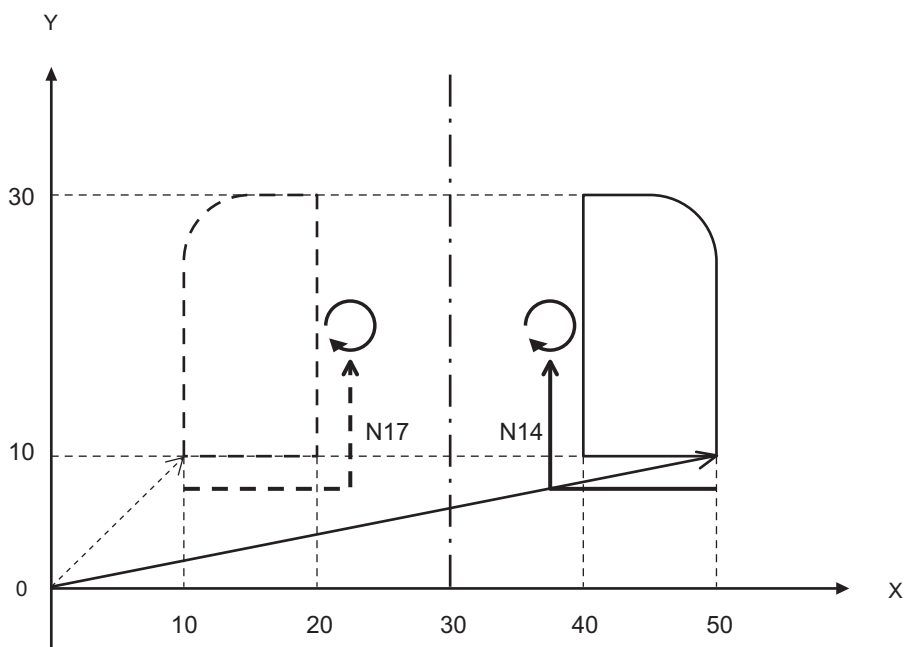

As shown in the above figure, the rotation direction of the spindle axis does not change in mirroring. As Up cut/Down cut are not maintained, adjust the rotation direction of the spindle axis according to your purpose.

G68, G69 Coordinate System Rotation

These instructions rotate a specified figure.

Modal/Non-modal		Modal
Modal group		16 rotation
Instruction format	Enables rotation	G68 X- Y- Z- R-
	Disables rotation	G69
Relevant G codes		G00, G01, G02, G03, G17, G18, G19

Parameters

Parameter	Name	Description
X	X-axis center point	Specifies a center point [command units] on the X-axis.
Y	Y-axis center point	Specifies a center point [command units] on the Y-axis.
Z	Z-axis center point	Specifies a center point [command units] on the Z-axis.
R	Rotation angle	Specifies a rotation angle [deg].

Function

The G68 and G69 rotate the current coordinates. G69 disables rotations, and G68 enables rotation. In the instruction format, X, Y, and Z indicate the center point. If any of them is omitted, the omitted value is handled as the current position. The X, Y, and Z values are handled as absolute positions. R indicates a rotation angle, and if it is omitted, an error occurs. The user can select XY, ZX, or YZ plane by using the G17, G18, or G19.

Programming Example

The following program rotates a figure defined in the subprogram.

```

N11 G17 G64 G91 G01 F1000
N12 M03 S500
N13 X10
N14 G68 X10 Y0 R90           // Sets the rotation angle to 90°
N15 M98 P1000                // Cuts the rotated figure (indicated by the solid
                             // line in the following figure)
N16 G69                       // Disables rotation
N17 M98 P1000                // Cuts the unrotated figure (indicated by the
                             // broken line in the following figure)

N18 M05
N19 M30

// Subprogram drawing a triangle
// NC Program No.1000
N01 G17 G01 X10 Y3
N02 Y-6
N03 X-10 Y3
N04 M99                       // End of the subprogram

```

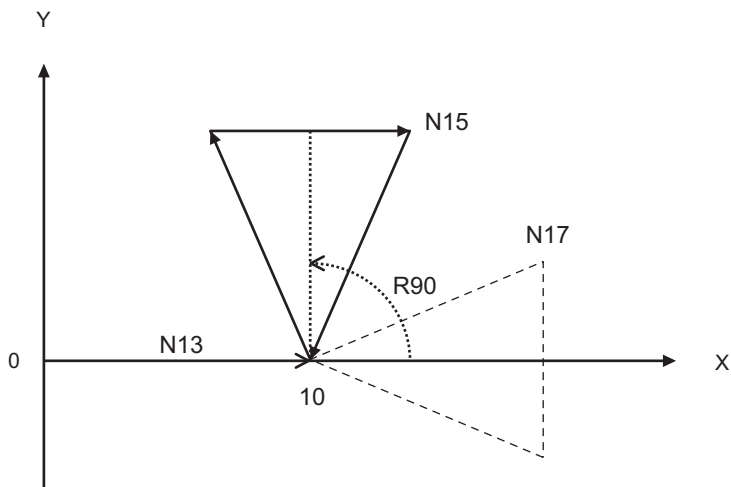

Utilities

Instruction	Name	Page
G74	Left-handed Tapping Cycle	P. 2-60
G80	Fixed Cycle Cancel	P. 2-62
G84	Tapping Cycle	P. 2-63
G98	Fixed Cycle Return to Initial Level	P. 2-66
G99	Fixed Cycle Return to R Point Level	P. 2-67

G74 Left-handed Tapping Cycle

This instruction performs reverse tapping machining.

Modal/Non-modal	Modal
Modal group	09 Fixed cycle
Instruction format	G74 X- Y- Z- R- P- K-
Relevant G codes	G80, G98, G99, G90, G91

Parameters

Parameter	Name	Description
X	Target X-axis Position	Specifies the destination position [command units] on the X-axis.
Y	Target Y-axis Position	Specifies the destination position [command units] on the Y-axis.
Z	Z point	Specifies the position of Z point [command units].
R	R point	Specifies the position of R point [command units].
P	Dwell time	Specifies a stop time [ms] at the Z point.
K	Number of repetitions	Specifies a number of repetitions of the fixed cycle.

Function

This command is convenient for tapping. Internally, it is substituted by the code corresponding to the following. This command uses an M code. Therefore, in order to execute the Left-handed Tapping Cycle (G74) or Tapping Cycle (G84) correctly, the M-code reset queue needs to be processed by the sequence control program correctly.

The X and Y words indicate the initial level, Z word indicates the Z point, R word the R point level, P word the dwell time, and K word the number of repetitions. If the K word is omitted, it is assumed to be K=1.

● When the CNC coordinate system has the spindle axis

```
G74 Xx Yy Zz Rr Pp Kk
```

```
//if G91 and G98 are activated
M19
//Execute below code k times
G00 Xx Yy //Initial level
G00 Zr //R point level
G01 Zz //Z point
G04 Pp //dwell
G01 Z-z //R point level
G00 Z-r //Initial level
//End of repetition
M5
```

```
//if G91 and G99 are activated
M19
//Execute below code k times
G00 Xx Yy //Initial level (first time) -> R point level (from the second)
(G00 Zr //R point level (first time only))
G01 Zz //Z point
G04 Pp //dwell
G01 Z-z //R point level
//End of repetition
M5
```

The spindle axis internally functions as the C-axis. In this case, positions of Z-axis and spindle axis synchronize.

If the spindle axis is assigned to the coordinate system, the number of rotations of spindle axis from the R point level to the Z point is as follows.

$$\text{Spindle speed} = \text{Z-axis movement amount} \times \frac{S}{F}$$

● When the CNC coordinate system does not have the spindle axis

<pre>G74 Xx Yy Zz Rr Pp Kk</pre>	
<pre>//if G91 and G98 are activated //Execute below code k times G00 Xx Yy //Initial level G00 Zr //R point level M19 M04 G01 Zz //Z point G04 Pp //dwell M03 G01 Z-z //R point level M04 G01 Z-r //Initial level</pre>	<pre>//if G91 and G99 are activated //Execute below code k times G00 Xx Yy //Initial level (first time) -> R point level (from the second) (G00 Zr //R point level (first time only)) M19 M04 G01 Zz //Z point G04 Pp //dwell M03 G01 Z-z //R point level M04</pre>

In this case, the Z-axis and spindle axis positions can be synchronized by using the sequence control program.

When the spindle axis is not assigned to the coordinate system and to determine the number of rotations of spindle axis, consult the instruction manual provided by the machine tool manufacturer.

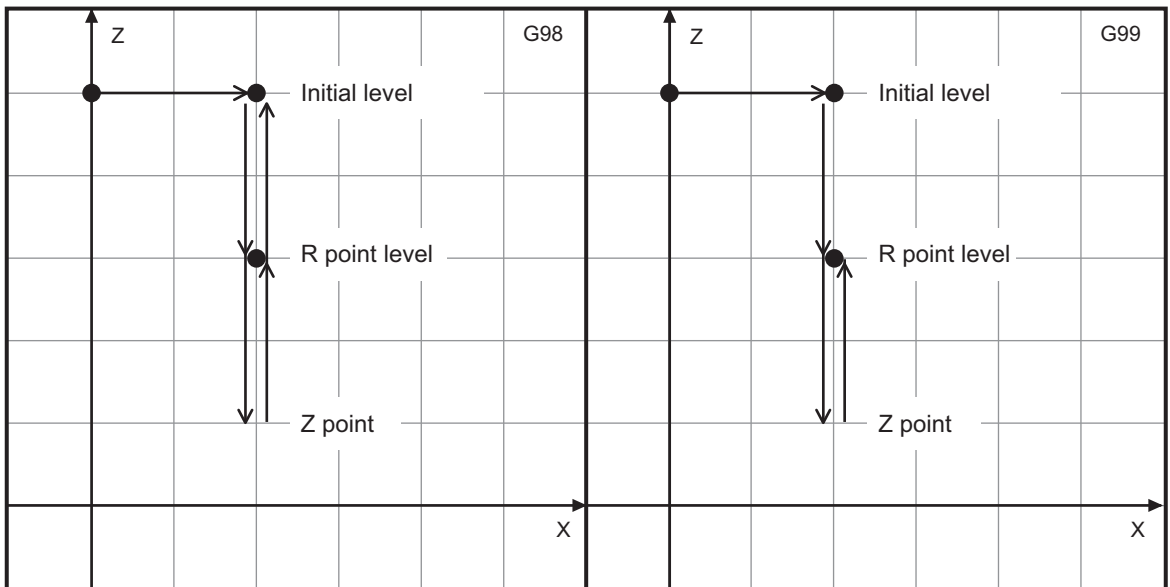

Programming Example

Refer to the programming example of *G84 Tapping Cycle* on page 2-63.

G80 Fixed Cycle Cancel

This instruction cancels a fixed cycle.

Modal/Non-modal	Modal
Modal group	09 Fixed cycle
Instruction format	G80
Relevant G codes	G74, G84

Parameters

This command does not have any parameters to set.

Function

This command must be inserted into the end of a fixed cycle.

G84 Tapping Cycle

This instruction performs tapping machining.

Modal/Non-modal	Modal
Modal group	09 Fixed cycle
Instruction format	G84 X- Y- Z- R- P- K-
Relevant G codes	G80, G98, G99, G90, G91

Parameters

Parameters are the same as for Left-handed Tapping Cycle (G74).

Function

This command is the same as Left-handed Tapping cycle (G74) except that the rotation direction of spindle axis is different. This command interchanges Spindle CW (M03) and Spindle CCW (M04) from Left-handed Tapping Cycle (G74).

Programming Example

The following program makes three holes consecutively. The return point of the first and last hole making is handled as the initial level, and that of other hole making as the R point to shorten the cycle time. The command position follows the specifications for the Absolute Dimension (G90) and Incremental Dimension (G91).

● Absolute dimension

```

N01 G17 G64 G90 F100 S300           // Absolute dimension
N02 G99 G84 X10 Y0 Z-10 R-5 P1000 K1 // Starts a tapping cycle
N03 G99 X20
N04 G98 X30
N05 G80                             // End of tapping cycle
N06 X40
N07 M30

```

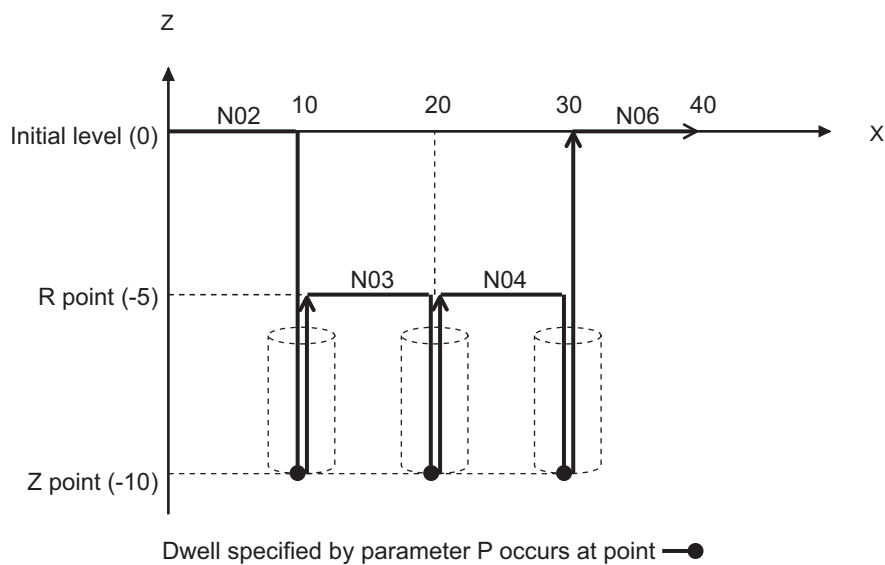

● Incremental dimension

```

N01 G17 G64 G91 F100 S300           // Incremental dimension
N02 G99 G84 X10 Y0 Z-10 R-5 P1000 K1 // Start of tapping cycle
N03 G99 X10
N04 G98 X10
N05 G80                             // End of tapping cycle
N06 X10
N07 M30

```

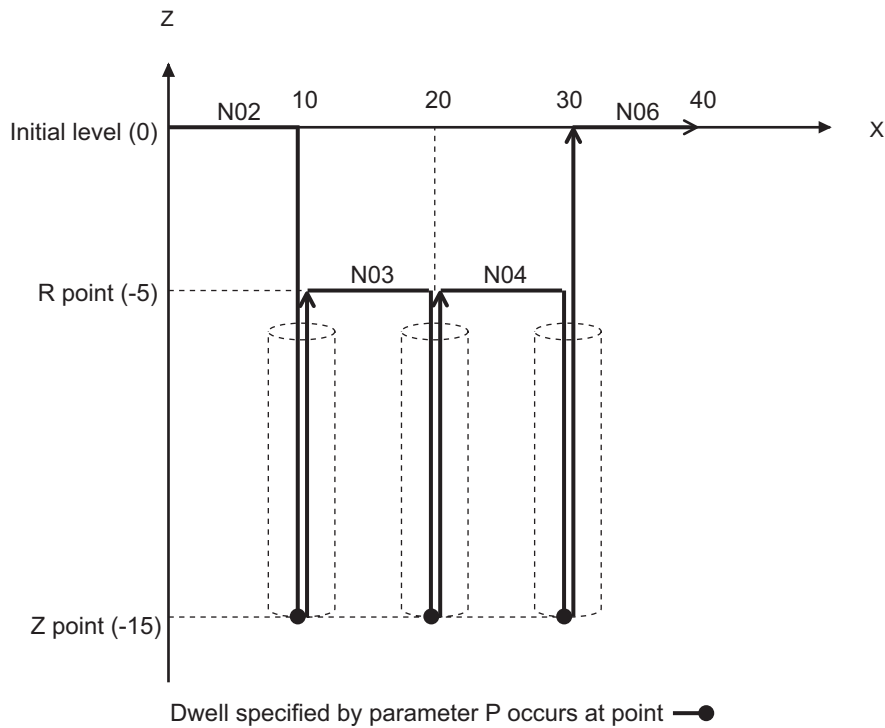

In a period between the start of Left-handed Tapping Cycle (G74) or Tapping Cycle (G84) and the call of Fixed Cycle Cancel (G80), the following restrictions apply.

- If Rapid Positioning (G00), Linear Interpolation (G01), or Circular Interpolation (G02/G03) is specified, the Fixed Cycle is canceled.
- Subprogram Call (M98) is disabled.
- Any code other than Left-handed Tapping Cycle (G74), Tapping Cycle (G84), Fixed Cycle Return to Initial Level (G98), and Fixed Cycle Return to R Point Level (G99) cannot be written.

G98 Fixed Cycle Return to Initial Level

This instruction sets the return position of a fixed cycle to the initial level.

Modal/Non-modal	Modal
Modal group	10 Return level
Instruction format	G98
Relevant G codes	G74, G84

Parameters

This command does not have any parameters to set.

Function

This command sets the return position of a fixed cycle to the initial level. Refer to each command for details.

G99 Fixed Cycle Return to R Point Level

This instruction sets the return position of a fixed cycle to the R-point level.

Modal/Non-modal	Modal
Modal group	10 Return level
Instruction format	G99
Relevant G codes	G74, G84

2

Parameters

Parameters

This command does not have any parameters to set.

Function

This command sets the return position of a fixed cycle to the R point level. Refer to each command for details.

Chamfer and Fillet Functions

This NC Integrated Controller does not support chamfer and fillet functions. These functions can use with Linear Interpolation (G01) and Circular Interpolation (G02, G03).

Supporting the chamfer function

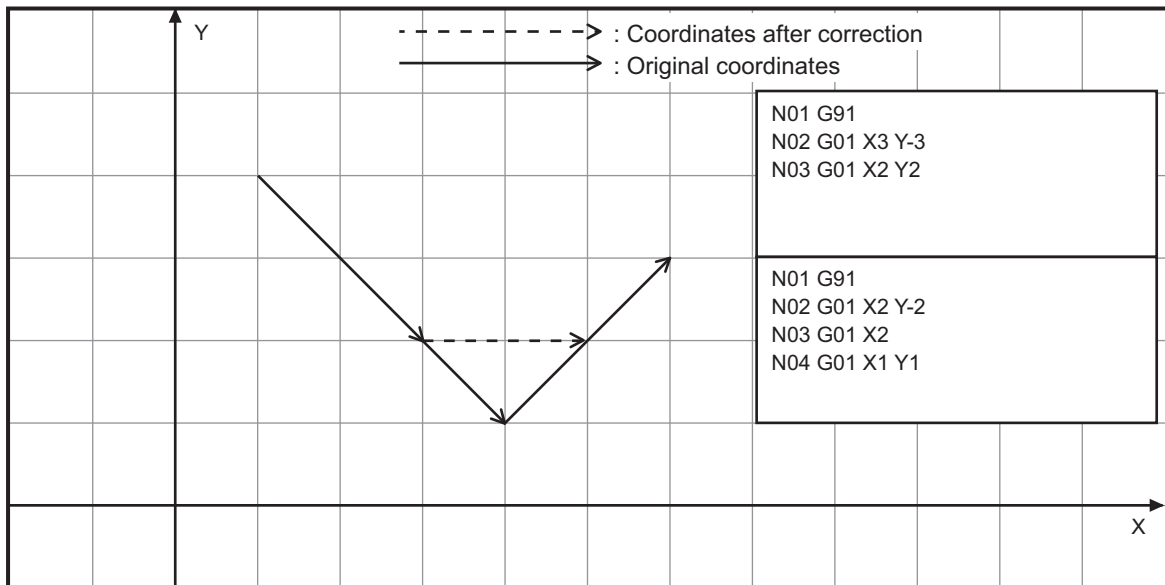

Supporting the fillet function

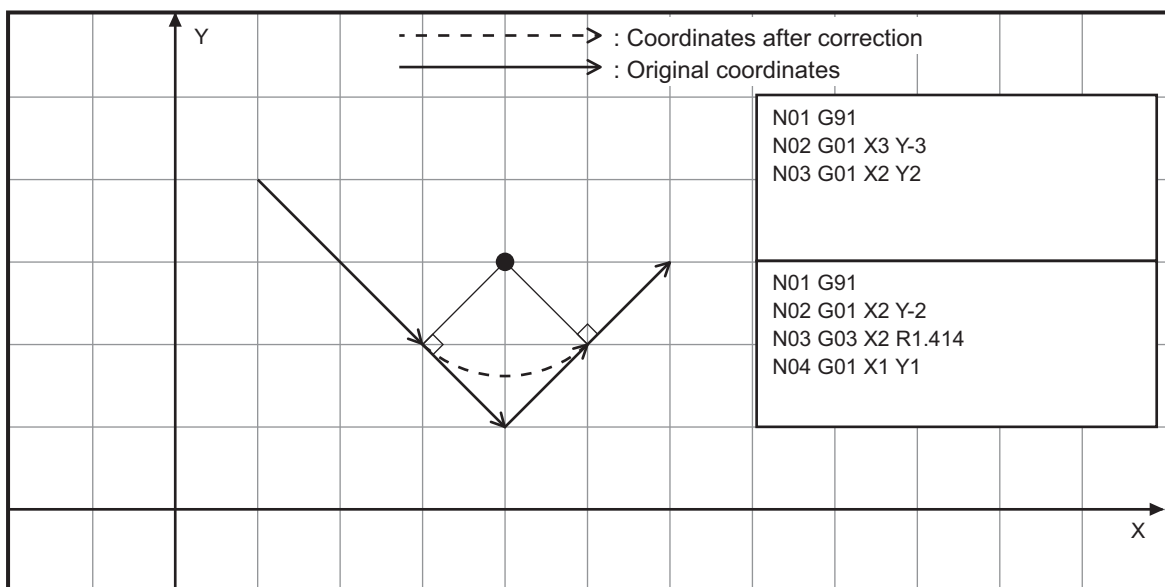

3

M Code

This section describes the specifications of the M code.

Auxiliary Function Output	3-3
Reservation Auxiliary Functions	3-7
Spindle Axis	3-11
Programming	3-19

Auxiliary Function Output

Instruction	Name	Page
M	Auxiliary Function Output	P. 3-5

Auxiliary Function Output sends the command from the NC program with machine auxiliary functions that are performed in the sequence control program. The sequence control program reads the output from the NC program with a CNC instruction.

Also, you can make a program to respond to the Auxiliary Function Output with a CNC instruction in the sequence control program. The Auxiliary Function Output is reset with a CNC instruction in the sequence control program.

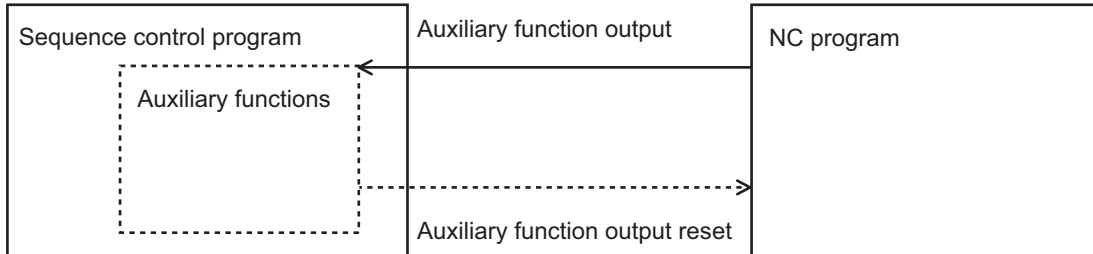

The output timing can be defined for each auxiliary function, whether it is simultaneously with the movement command or after completion of movement.

An auxiliary function defined to output after completion of movement stops its pre-read when it is executed. (Modal status does not change.)

```
N30 G1 X1000
N40 M10
N50 G1 X2000
```

● **After completion of movement**

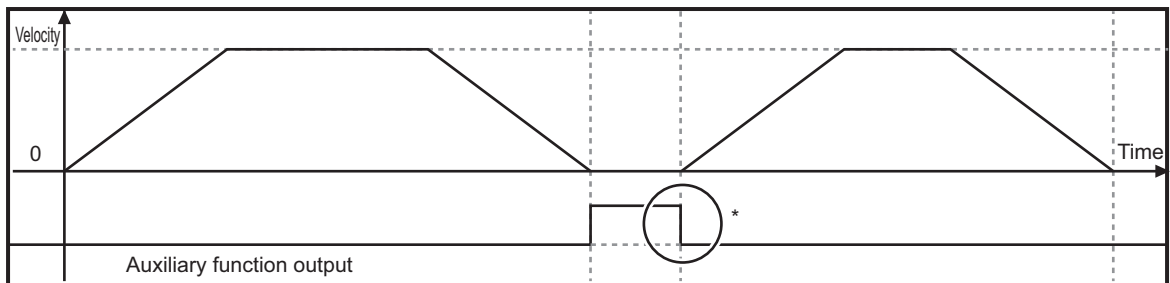

The block is not progressed until the output is reset.

● **Simultaneously with movement command**

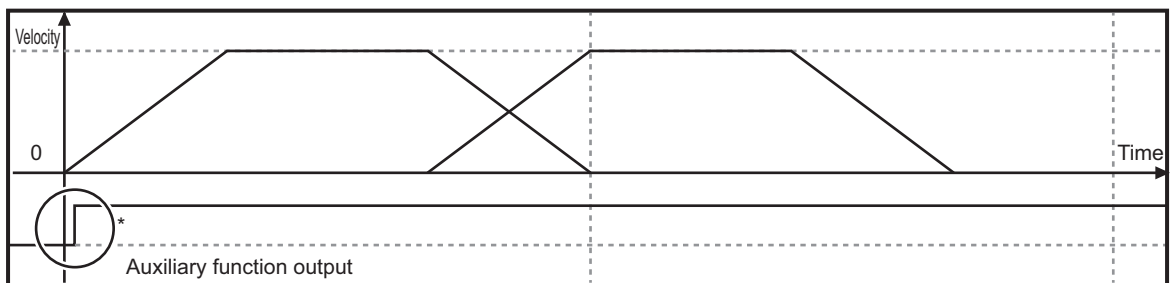

This is the timing of command interpretation, and does not synchronize with operations.

M Code Descriptions

The M code is information used to interlock with external devices in each process of positioning operation.

Instruction format	M{data}[[VA{data} VB{data} VC{data} VD{data} VE{data} VF{data} VG{data} VH{data}]]
---------------------------	--

- Specify a number (0 to 191) after M-code.
- M code is independent for each CNC coordinate system.
- Up to eight parameters (VA to VH) can be specified for each M code.
- Auxiliary Function Outputs that have parameters are always executed after completion of movement.
- An Auxiliary Function Output that has parameters waits for completion of auxiliary function (reset from the sequence control program) in a block with the auxiliary function outputs setting.
- Specify the parameters if you want to make the NC program wait until machine control is completed by the sequence control program.
- No parameters can be specified for M00, M01, M02, M30 and M99.
- M98 specifies an inherent parameter. Refer to *M98 Subprogram Call* on page 3-20 for details.
- A reset from the sequence control program must be commanded for each M code.
- A single auxiliary function output can be commanded to a single block.

Reservation Auxiliary Functions

Instruction	Name	Page
M00	Program Stop	P. 3-8
M01	Optional Stop	P. 3-9
M02/M30	End of Program	P. 3-10

M00 Program Stop

This instruction stops the NC program.

Instruction format	M00
Relevant M codes	---

The NC program is stopped at the block where M00 is commanded.

The machine status (modal status) does not change after the stop until the operation is restarted or wound back.

M01 Optional Stop

This instruction stops the NC program by optional input.

Instruction format	M01
Relevant M codes	---

As is the case with M00, execution of the NC program is stopped at the block where M01 is commanded, subject to Optional input.

M02, M30 End of Program

These instructions end the NC program.

Instruction format	M02 M30
Relevant M codes	---

Indicates the end of the NC program.

The NC program is stopped to enable reset mode.

When a block where M30 is specified is executed, return to the head of the program.

Therefore, the blocks after M30 or M02 are ignored.

M02 and M30 have the same function.

Spindle Axis

Instruction	Name	Page
S	Spindle Axis Rotation Function (S function)	P. 3-12
M03	Spindle CW	P. 3-13
M04	Spindle CCW	P. 3-14
M05	Spindle OFF	P. 3-15
M19	Spindle Orientation	P. 3-16

Spindle Axis Rotation Function (S function)

This instruction specifies a rotational speed of the spindle axis.

Modal/Non-modal	Modal
Instruction format	S{data}
Relevant M codes	M03, M04

Specifies the rotational speed of the spindle axis with a number (0 or positive number) next to S code.

The unit of rotational speed is r/min (revolutions per minute).

The spindle axis is not operated simply by specifying the rotational speed.

To run the spindle axis, use the Auxiliary Function Output (M03/M04).

When the spindle axis is rotated by auxiliary function output (M03/M04) and if the S-code value is changed, it is reflected on the spindle axis speed immediately.

M03 Spindle CW

This instruction rotates the spindle clockwise (CW).

Instruction format	M03
Relevant M codes	S{data}, M05

Rotates the spindle axis in the clockwise direction at the specified speed.

If the spindle axis is already activated, its speed is changed according to the rotation direction and the rotational speed that is set.

For the information on the spindle axis operation and the timing of completion of M03, refer to the instruction manual provided by the machine tool manufacturer.

For the acceleration/deceleration at startup, reversing, and changing velocity, also refer to the instruction manual provided by the machine tool manufacturer.

Programming Example

The following program operates the spindle axis in the order of clockwise and counter-clockwise, then stop.

```

N01 S300
N02 M03      // Spindle CW
N03 G04 X1
N04 M04      // Spindle CCW
N05 G04 X1
N06 M05      // Spindle OFF
N07 M30

```

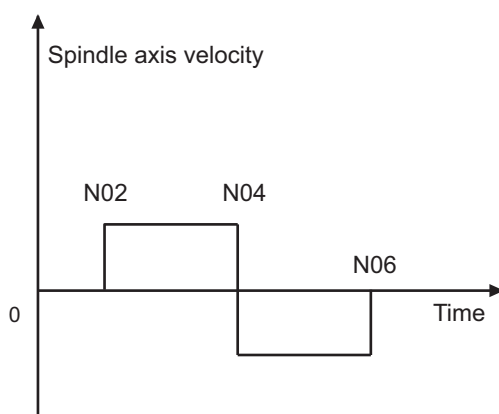

M04 Spindle CCW

This instruction rotates the spindle counter-clockwise (CCW).

Instruction format	M04
Relevant M codes	S{data}, M05

Operates the spindle axis in the counter-clockwise direction at the specified speed.

If the spindle axis is already activated, its speed is changed according to the rotation direction and the rotational speed that is set.

For the information on the spindle axis operation and the timing of completion of M04, refer to the instruction manual provided by the machine tool manufacturer.

For the acceleration/deceleration at startup, reversing, and changing velocity, also refer to the instruction manual provided by the machine tool manufacturer.

Programming Example

Refer to the programming example of *M03 Spindle CW* on page 3-13.

M05 Spindle OFF

This instruction stops the spindle.

Instruction format	M05
Relevant M codes	S{data}, M03, M04

Stops the spindle axis.

For the information on the spindle axis operation and the timing of completion of M05, refer to the instruction manual provided by the machine tool manufacturer.

For the deceleration at stopping, also refer to the instruction manual provided by the machine tool manufacturer.

Programming Example

Refer to the programming example of *M03 Spindle CW* on page 3-13.

M19 Spindle Orientation

This instruction stops the spindle at the specified phase position.

Instruction format	M19
Relevant M codes	M03, M04, M05

Use this command to adjust phase of the spindle axis when you replace tools and carry out other tasks.

This function rotates the spindle axis at the Spindle orientation velocity setting, and stops it at the phase position specified for the Spindle orientation position setting. It is a positioning function specified the rotation position (angle) of a tool.

If the spindle axis is already activated, it changes its speed to the Spindle orientation velocity and stops at the Spindle orientation position.

For the information on the spindle axis operation and the timing of completion of M19, refer to the instruction manual provided by the machine tool manufacturer.

For the deceleration at stopping, also refer to the instruction manual provided by the machine tool manufacturer.

Programming Example

The following program returns the tool to the reference point and the spindle axis to a tool change position, from the state where the spindle axis is rotating, while moving the tool rotation position to a position where the tool can be changed.

```

N01 G17 G64 G91 G01 F100
N02 M03 S300
N03 M19 // Starts stopping with spindle orientation.
N04 G28 // Moves to a tool change position.
N05 M30

```

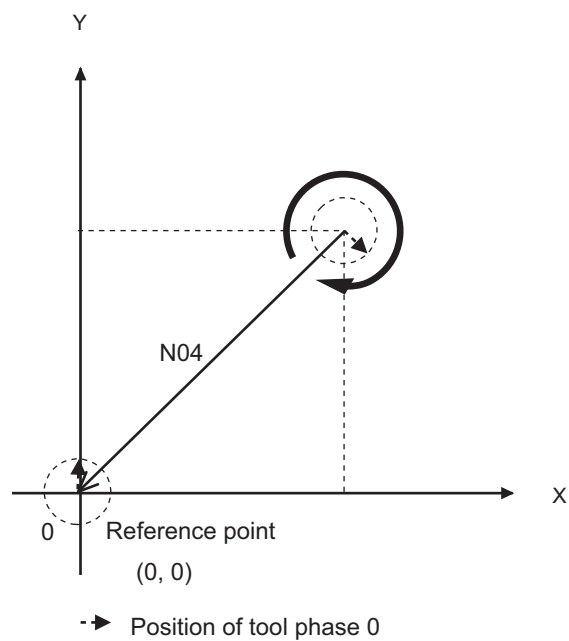

Programming

Instruction	Name	Page
M98	Subprogram Call	P. 3-20
M99	Subprogram End	P. 3-21

M98 Subprogram Call

The M98 is a function to call a subprogram from the program currently running.

Specify a subprogram to call by a number next to the P argument.

The called subprogram is executed from the first block.

When M99 is executed in the subprogram, the execution control returns to the main program from which the subprogram was called.

If the specified subprogram is not found, an alarm is output and the program stops running.

Instruction format	M98 P{data} [L{data}]
Relevant M codes	M99

When you specify P1000 as shown in the following sample, subprogram 1000 is called.

```
N30 M98 P1000 // Calls subprogram P1000.
N40 G00 X100
```

Also when you specify the number 10 after the L argument as shown in the following, the subprogram can be called 10 times.

```
N30 M98 P1000 L10 // Calls the P1000 subprogram 10 times.
N40 G00 X100
```

Subprograms must be called within the depth of 8. The depth is counted from 1.

If the depth exceeds 8, subprograms are not invoked but the next block is executed.

Programming Example

Refer to the programming example of *G50.1, G51.1 Mirroring* on page 2-55.

M99 Subprogram End

The M99 is a function to return the execution control from the program currently running to the other program from which the current program was called.

The M99 function behaves differently between when a subprogram is called by a subprogram and when it is called by a main program.

When the subprogram is called from a subprogram, it returns execution control to the main program from which the subprogram was called (M98).

When the subprogram is executed by the main program, it terminates the program by executing M30.

Instruction format	M99
Relevant M codes	M98

4

PROGRAM CODES

This section describes the specifications of program codes.

4

4-1	Calculation and Logic Operation	4-2
4-1-1	Operator priority	4-2
4-1-2	Arithmetic operators	4-2
4-1-3	Functions	4-3
4-1-4	Condition comparators	4-5
4-1-5	Conditional join operators	4-5
4-2	Branch and Repetition	4-6
4-2-1	if/else	4-6
4-2-2	switch/case	4-6
4-2-3	while	4-6
4-2-4	do/while	4-6
4-3	User Variables	4-7
4-3-1	Local Variables ("L")	4-7
4-3-2	Coordinate System Global Variables ("Q")	4-7
4-3-3	Global Variables ("P")	4-7
4-3-4	Variable Indirection	4-7

4-1 Calculation and Logic Operation

4-1-1 Operator priority

Priority	Operators	Combination order
High	- (Unary)	
	!	
	*, /, %	Left combination
	+, -	Left combination
	==, !=, <, >, <=, >=	
	&&	
Low		

4-1-2 Arithmetic operators

Addition (+)

This operator adds numbers. This is a binary operator and cannot be used as a unary operator.

```
L3=L1+L2 // OK
L2=+L1 // NG
L2=+1 // OK. Just numerical value
```

Subtraction and positive/negative inversion (-)

This operator subtracts numbers, or converts the polarity of a number. It performs subtraction when used as a binary operator, or conversion when used as a unary operator.

```
L3=L1-L2 // OK
L2=-L1 // OK
L2=-1 // OK. Just numerical value
```

Multiplication (*)

This operator is a binary operator that multiplies numbers.

```
L3=L1*L2 // OK
```

Division (/)

This operator is a binary operator that divides numbers.

```
L3=L1/L2 // OK
L0=0/0 // nan
L0=1/0 // inf
L0=-1/0 // -inf
```

Modulo (%)

This binary operator gives a surplus (remainder of division).

```
L0=7%3 // 1
L0=-7%3 // -1
L0=7%-3 // 1
L0=-7%-3 // -1
L0=7%4.5 //2.5
L0=7%0 // nan
```

4-1-3 Functions

Scalar function

Syntax	Operation	Domain [Unit]	Range [Unit]
abs({expression})	Absolute value	All real numbers	A real number that is not a negative value
acos({expression})	Arc cosine (arccos) of trigonometric function	-1.0 to +1.0	0 to Pi [Radian]
acosd({expression})	Arc cosine (arccos) of trigonometric function	-1.0 to +1.0	0 to 180 [degree]
acosh({expression})	Inverse hyperbolic cosine	Positive real number > 1.0	Positive real number [Radian]
asin({expression})	Arc sine (arcsin) of trigonometric function	-1.0 to +1.0	-Pi/2 to Pi/2 [Radian]
asind({expression})	Arc sine (arcsin) of trigonometric function	-1.0 to +1.0	-90 to +90 [degree]
asinh({expression})	Inverse hyperbolic sine	All real numbers	All real numbers [Radian]
atan({expression})	Arctangent (arctan) of trigonometric function	All real numbers	-Pi/2 to Pi/2 [Radian]
atan2({expression1}, {expression2})	Arctangent (arctan) of trigonometric function of two arguments	All real numbers in both arguments (but never two become zero at the same time)	-Pi to +Pi [Radian]
atan2d({expression1}, {expression2})	Arctangent (arctan) of trigonometric function of two arguments	All real numbers in both arguments (but never two become zero at the same time)	-180 to +180 [degree]
atand({expression})	Arctangent (arctan) of trigonometric function	All real numbers	-90 to +90 [degree]

Syntax	Operation	Domain [Unit]	Range [Unit]
atanh({expression})	Inverse hyperbolic tangent	-1.0 to +1.0	All real numbers [Radian]
cbrt({expression})	Cube root	All real numbers	All real numbers
ceil({expression})	Round to a larger integer	All real numbers	All real numbers
cos({expression})	Cosine of trigonometric function (cos)	All real numbers [Radian]	-1.0 to +1.0
cosd({expression})	Cosine of trigonometric function (cos)	All real numbers [Degree]	-1.0 to +1.0
cosh({expression})	Hyperbolic cosine	All real numbers [Radian]	Positive real number ≥ 1.0
exp({expression})	Power of base e (e^x)	All real numbers	Positive real number
exp2({expression})	Power of base e (2^x)	All real numbers	Positive real number
floor({expression})	Round to a smaller integer	All real numbers	All real numbers
int({expression})	Round to a smaller integer	All real numbers	All real numbers
isnan({expression})	Check for nonnumeric (NaN)	Display of all real numbers, not a number (NaN)	0, 1 (0: False, 1: True)
log({expression})	Natural logarithm	Positive real number	All real numbers
log10({expression})	Logarithm of base 10	Positive real number	All real numbers
log2({expression})	Logarithm of base 2	Positive real number	All real numbers
pow({expression}, {expression})	Exponentiation	All real numbers	All real numbers
qnr({expression})	Fifth root	All real numbers	All real numbers
qr({expression})	Fourth root	A real number that is not a negative value	A real number that is not a negative value
rint({expression})	Rounding off	All real numbers	All real numbers
sin({expression})	Sine of trigonometric function (sin)	All real numbers [Radian]	-1.0 to +1.0
sind({expression})	Sine of trigonometric function (sin)	All real numbers [Degree]	-1.0 to +1.0
sinh({expression})	Hyperbolic sine	All real numbers [Radian]	All real numbers
sgn({expression})	Arithmetic code	All real numbers	-1, 0, +1
sqrt({expression})	Square root	A real number that is not a negative value	A real number that is not a negative value
tan({expression})	Tangent of trigonometric function (tan)	All real numbers other than $\pm(2N-1)\pi/2$ [Radian]	All real numbers
tand({expression})	Tangent of trigonometric function (tan)	All real numbers other than $\pm(2N-1)90^\circ$ [Degree]	All real numbers
tanh({expression})	Hyperbolic positive	All real numbers [Radian]	-1.0 to +1.0

4-1-4 Condition comparators

Condition comparators are used to compare numbers. The result of comparison is represented by a truth-value (TRUE or FALSE). The truth-value is not adapted to general numerical expressions.

Syntax	Operation
{exp1} == {exp2}	Equality comparison operator
{exp1} != {exp2}	None equality comparison operator
{exp1} < {exp2}	Less than comparison operator
{exp1} > {exp2}	Greater than comparison operator
{exp1} <= {exp2}	Less than or equal comparison operator
{exp1} >= {exp2}	Greater than or equal comparison operator

4-1-5 Conditional join operators

Conditional join operators are used to join truth-values.

Syntax	Operation
{condition1} && {condition2}	Logical AND operation
{condition1} {condition2}	Logical OR operation
!({condition})	Logical negation

Logical negation operator (!) always require ().

4-2 Branch and Repetition

4-2-1 if/else

For conditional sentence “if({condition})”, the command(s) right after this sentence is executed when the condition is TRUE. If the left brace ({) is found right after this conditional sentence, all the subsequent commands to the right brace (}) are executed in accordance with the condition.

If the “else” statement follows the command right after the “if({condition})” sentence or the command set enclosed by braces, the command or command set enclosed by braces right after the “else” statement are executed when “if” statement is FALSE. The “else” statement may be omitted.

4-2-2 switch/case

For “switch({expression})” conditional sentence, the value of the expression is evaluated and the value is truncated to an integer value if necessary. If a “case” conditional sentence that specifies the matching integer is found, the program execution moves to that “case” conditional sentence. The execution continues until “break” statement is found. It also continues if a subsequent “case” branch is found. “break” statement makes the execution jump to a program command following the end line of the whole “switch” conditional description.

If “break” statement is not written after the “case” branch, the execution continues until the whole “switch” conditional description ends, then proceeds to the following commands. If no “case” conditional sentence is found that matches the evaluated value of the “switch” expression, the program execution jumps to the “default” branch. If the “default” branch is not found, the execution jumps to a program command right after the end of the whole “switch” conditional description.

4-2-3 while

For conditional sentence “while({condition})”, the command(s) right after this sentence is executed when the condition is TRUE. If the left brace ({) is not found right after this conditional sentence, the program is executed when only one of the subsequent commands is TRUE.

If the left brace ({) is found right after this conditional sentence, the program is executed when all the subsequent commands to the right brace (}) are TRUE. When the execution of a command or command set enclosed by braces is completed, the process automatically returns to the “while” conditional sentence, and the loop ends.

When the condition of the “while” statement is FALSE, the execution skips the command right after the “while” conditional sentence or command set enclosed by braces, and jumps to a command right after it.

4-2-4 do/while

For conditional sentence “do..while({condition})”, the command right after the “do” statement or command set enclosed by braces is always executed once. When the condition of the “while” statement after this command or command set is TRUE, the execution returns to the “do” statement, and the loop ends. When the condition is FALSE, the execution continues the following command.

4-3 User Variables

4-3-1 Local Variables ("L")

These variables can be shared by the same subprograms. They are 64-bit floating point arrays independent in each subprogram. The user can use from L0 to L255, but cannot use L256 and subsequent variables.

4-3-2 Coordinate System Global Variables ("Q")

These variables can be shared by the same CNC coordinate systems. They are 64-bit floating point arrays independent in each CNC coordinate system. The user can use from Q0 to Q4095, but cannot use Q4096 and subsequent variables.

4-3-3 Global Variables ("P")

They are the sole 64-bit floating point arrays that can be shared inside the Controller. The user can use from P0 to P32767, but cannot use P32768 and subsequent variables.

4-3-4 Variable Indirection

Indirection of variables that are used for parameters is available. It must be written in the form of Variable prefix [Variable name].

```
N01 G17 G64 G91 F300
N02 M03 S300
N03 L12=10 Q34=20 L56=30 // Substitution of values
N04 G01 X[L12] Y[Q34] Z[L56]// Set in the target
position for linear interpolation.
N05 M05
N06 M30
```

The indirection cannot be used in the program code.

```
P[P++] // Disabled
P[P0]=P1 // Disabled
P0=P[P1] // Disabled
if(Q[L0]==1){M99} // Disabled
```

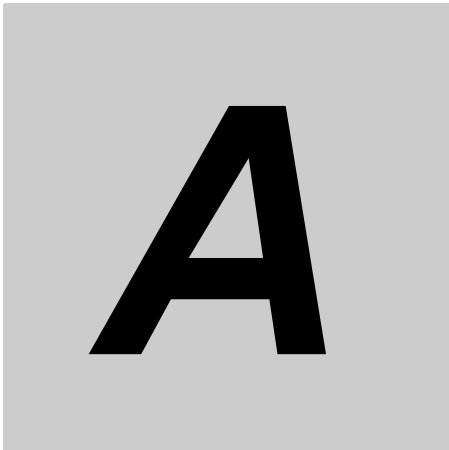
Appendices

A-1	Program Parsing by CNC Operator	A-2
A-1-1	Intermediate code format	A-2
A-1-2	Program Parsing Example	A-4



A-1 Program Parsing by CNC Operator

When a user creates an NC program, the CNC Operator converts it into intermediate codes and transfers them to an external SD card mounted on the NC Integrated Controller.

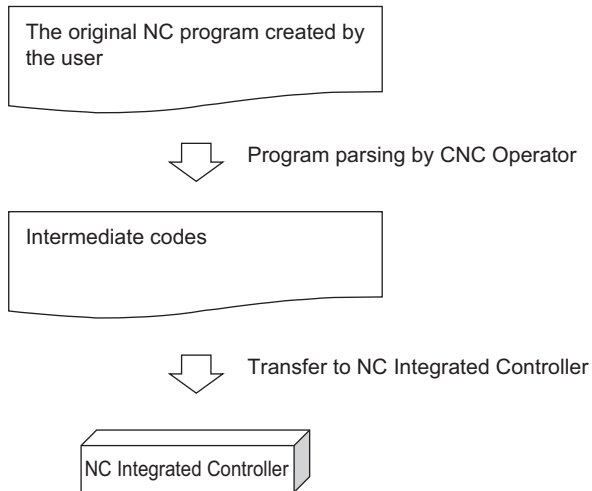

An NC program is converted into intermediate codes under the following rules.

Remember that intermediate codes cannot be converted reversely into the original NC program. Therefore, be sure to save the original NC program.

A-1-1 Intermediate code format

The following explains the intermediate code format that is generated in program parsing by CNC Operator.

File extension

The intermediate codes are created as a text file having the .pmc extension.

Header and Footer

In the main program, the open prog (program-number) header is inserted into the beginning of file. The close footer is inserted into the end of file.

In a subprogram, the open subprog (program-number) header is inserted into the beginning of file. The return/close footer is inserted into the end of file.

M99

A return is inserted into the block where M99 is written.

Between words

A space is inserted between words.

Block number

A block number is created as N + G-code line number before program parsing, regardless of its description or not.

Comment

Any content described as a comment is ignored by intermediate codes.

EOB (End of Block)

M999.001 or M999.002 is inserted into the end of block.

These M codes are necessary for the NC Integrated Controller for program interpretation, and it is not necessary for users be conscious about it. Therefore, waiting for an M code or resetting it is not required.

Optional Block Skip

"/" is replaced by "cskip".

Variable Indirection

A pair of square brackets "[]" is replaced by a pair of parentheses "()".

G74/G84

Internal G-code G80.001 is inserted immediately before G74/G84 that starts the fixed cycle.

M-code Parameters

If M-code parameters VA to VH are given, code V is removed and it is replaced by A to H.

A-1-2 Program Parsing Example

The following gives an example of program parsing by CNC Operator.

● The original NC program created by the user

Main program

```

N01 G17 G64 G91 G01 F1000
                                     // block-number = N{line-number}
N02 M03 S1000
/1 N03 X10                             // Optional Block Skip
N04 X[P0]                               // Variable Indirection
N05 if (Q0==1){X10}                    // Control syntax
N06 M98 P1000                           // Subprogram call
N07 M100 VA0                             // M-code

N11 G91 G99 G84 X10 Y0 Z-10 R-5 P1000 K1// Start of Tapping Cycle
N12 G99 X10
N13 G98 X10
N14 G80                                 // End of Tapping Cycle
N15 M05
N16 M30                                 // End of program

```

Subprogram

```

N01 G04 P100
N02 M99                                 // End of subprogram

```

● NC program after program parsing by CNC Operator

Main program

```

open prog 1
N1 G17 G64 G91 G01 F1000 M999.002
N3 M03 S1000 M999.002
cskip1 N4 X10 M999.002
N5 X(P0) M999.002
if(Q0 == 1)
{
N6 X10 M999.002
}
N7 M98 P1000 M999.002
N8 M100 A0 M999.002
N10 G91 G99 G80.001 G84 X10 Y0 Z-10 R-5 P1000 K1 M999.002
N11 G99 G84 X10 M999.002
N12 G98 G84 X10 M999.002
N13 G80 M999.002
N14 M05 M999.002
N15 M30 M999.002
close

```

Subprogram

```

open subprog 1000
N1 G04 P100 M999.002
N2 M99 M999.002 return
close

```

OMRON Corporation Industrial Automation Company
Kyoto, JAPAN

Contact: www.ia.omron.com

Regional Headquarters

OMRON EUROPE B.V.

Wegalaan 67-69, 2132 JD Hoofddorp
The Netherlands
Tel: (31)2356-81-300/Fax: (31)2356-81-388

OMRON ELECTRONICS LLC

2895 Greenspoint Parkway, Suite 200
Hoffman Estates, IL 60169 U.S.A.
Tel: (1) 847-843-7900/Fax: (1) 847-843-7787

OMRON ASIA PACIFIC PTE. LTD.

No. 438A Alexandra Road # 05-05/08 (Lobby 2),
Alexandra Technopark,
Singapore 119967
Tel: (65) 6835-3011/Fax: (65) 6835-2711

OMRON (CHINA) CO., LTD.

Room 2211, Bank of China Tower,
200 Yin Cheng Zhong Road,
PuDong New Area, Shanghai, 200120, China
Tel: (86) 21-5037-2222/Fax: (86) 21-5037-2200

Authorized Distributor:

© OMRON Corporation 2017-2018 All Rights Reserved.
In the interest of product improvement,
specifications are subject to change without notice.

Cat. No. O031-E1-02

0718