

# OMRON

Automation Software

# Sysmac Studio Version 1

## Drive Functions Operation Manual

SYSMAC-SE2□□□



**SYSMAC**  
always in control

I589-E1-06

## NOTE

All rights reserved. No part of this publication may be reproduced, stored in a retrieval system, or transmitted, in any form, or by any means, mechanical, electronic, photocopying, recording, or otherwise, without the prior written permission of OMRON.

No patent liability is assumed with respect to the use of the information contained herein. Moreover, because OMRON is constantly striving to improve its high-quality products, the information contained in this manual is subject to change without notice. Every precaution has been taken in the preparation of this manual. Nevertheless, OMRON assumes no responsibility for errors or omissions. Neither is any liability assumed for damages resulting from the use of the information contained in this publication.

## Trademarks

- Sysmac and SYSMAC are trademarks or registered trademarks of OMRON Corporation in Japan and other countries for OMRON factory automation products.
- Microsoft, Windows, Windows Vista, Excel, and Visual Basic are either registered trademarks or trademarks of Microsoft Corporation in the United States and other countries.
- EtherCAT® is registered trademark and patented technology, licensed by Beckhoff Automation GmbH, Germany.
- ODVA, CIP, CompoNet, DeviceNet, and EtherNet/IP are trademarks of ODVA.
- The SD and SDHC logos are trademarks of SD-3C, LLC. 
- NVIDIA, the NVIDIA logo, GeForce, and the GeForce logo are the trademarks or registered trademarks of NVIDIA Corporation in the USA and other countries.
- ATI™, Radeon™ is a trademark of Advanced Micro Devices, Inc..
- Celeron, Intel and Intel Core are trademarks of Intel Corporation in the U.S. and / or other countries.

Other company names and product names in this document are the trademarks or registered trademarks of their respective companies.

## Copyrights

Microsoft product screen shots reprinted with permission from Microsoft Corporation.

# Introduction

---

Thank you for purchasing Sysmac Studio Automation Software.

Sysmac Studio allows you to use a computer to program and set up Sysmac devices.

This manual describes the operating procedures of Sysmac Studio mainly for drive functions.

Use this manual together with the *Sysmac Studio Version 1 Operation Manual* (Cat. No. W504) and the user's manuals of the devices that you use.

## Intended Audience

This manual is intended for the following personnel, who must also have knowledge of electrical systems (an electrical engineer or the equivalent).

- Personnel in charge of introducing FA systems.
- Personnel in charge of designing FA systems.
- Personnel in charge of installing and maintaining FA systems.
- Personnel in charge of managing FA systems and facilities.

For programming, this manual is intended for personnel who understand the programming language specifications in international standard IEC 61131-3 or Japanese standard JIS B 3503.

## Notice

This manual contains information that is necessary to use the Sysmac Studio. Please read and understand this manual before using the Sysmac Studio. Keep this manual in a safe place where it will be available for reference during operation.

# Manual Structure

## Page Structure

The following page structure is used in this manual.

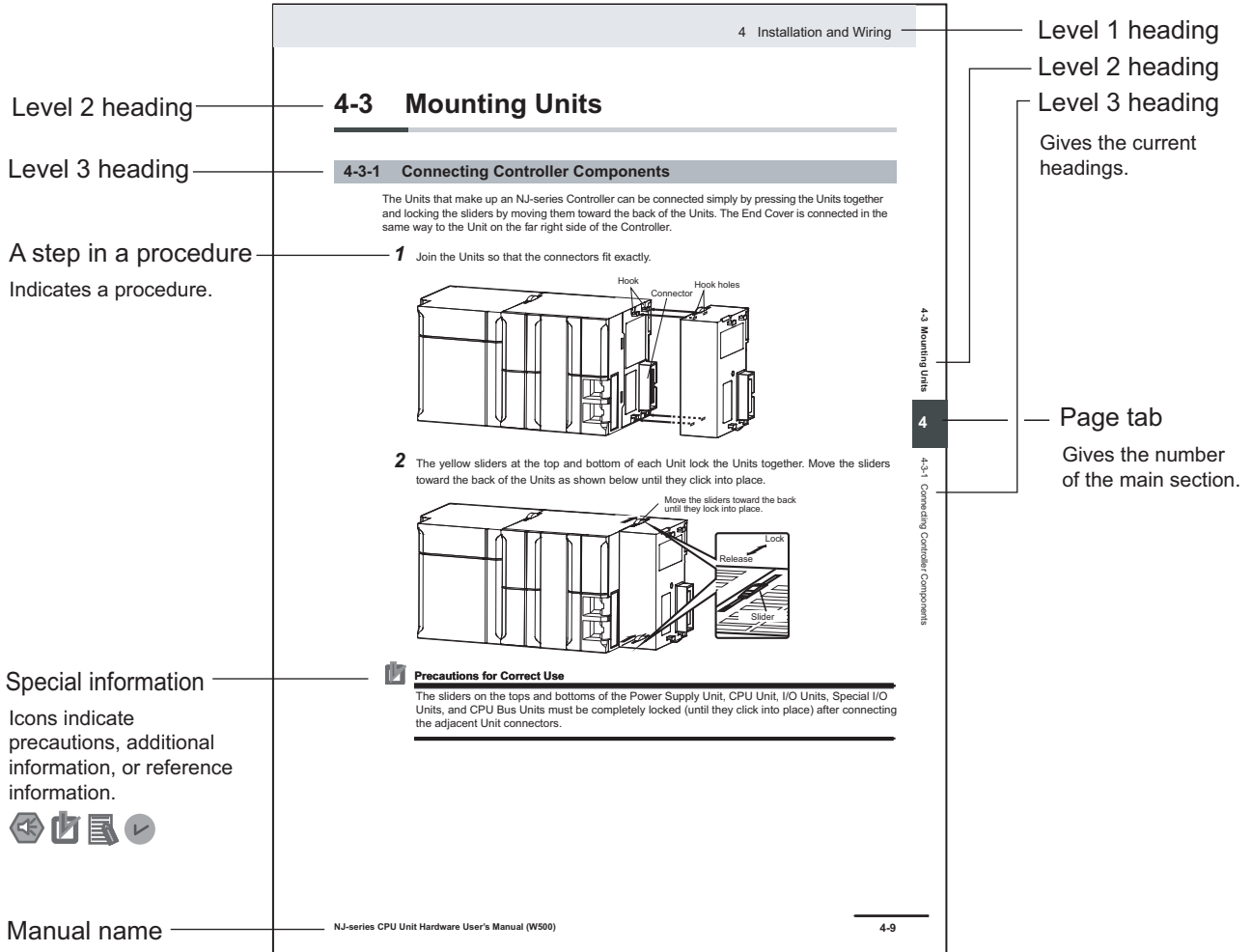

This illustration is provided only as a sample. It may not literally appear in this manual.



## Special Information

Special information in this manual is classified as follows:



### Precautions for Safe Use

Precautions on what to do and what not to do to ensure safe usage of the product.



### Precautions for Correct Use

Precautions on what to do and what not to do to ensure proper operation and performance.



### Additional Information

Additional information to read as required.

This information is provided to increase understanding or make operation easier.



### Version Information

Information on differences in specifications and functionality for CPU Units with different unit versions and for different versions of the Sysmac Studio is given.

Note References are provided to more detailed or related information.

## Precaution on Terminology

- In this manual, “download” refers to transferring data from the Sysmac Studio to the physical Controller and “upload” refers to transferring data from the physical Controller to the Sysmac Studio.  
For the Sysmac Studio, synchronization is used to both upload and download data. Here, “synchronize” means to automatically compare the data for the Sysmac Studio on the computer with the data in the physical Controller and transfer the data in the direction that is specified by the user.
- The Sysmac Studio supports the NJ/NX/NY-series Controllers. Unless another Controller series is specified, the operating procedures and screen captures used in the manual are examples for the NJ-series Controllers.

## Terminology

For descriptions of the Controller terms that are used in this manual, refer to information on terminology in the manuals that are listed in *Related Manuals* on page 19.



# Sections in this Manual

---

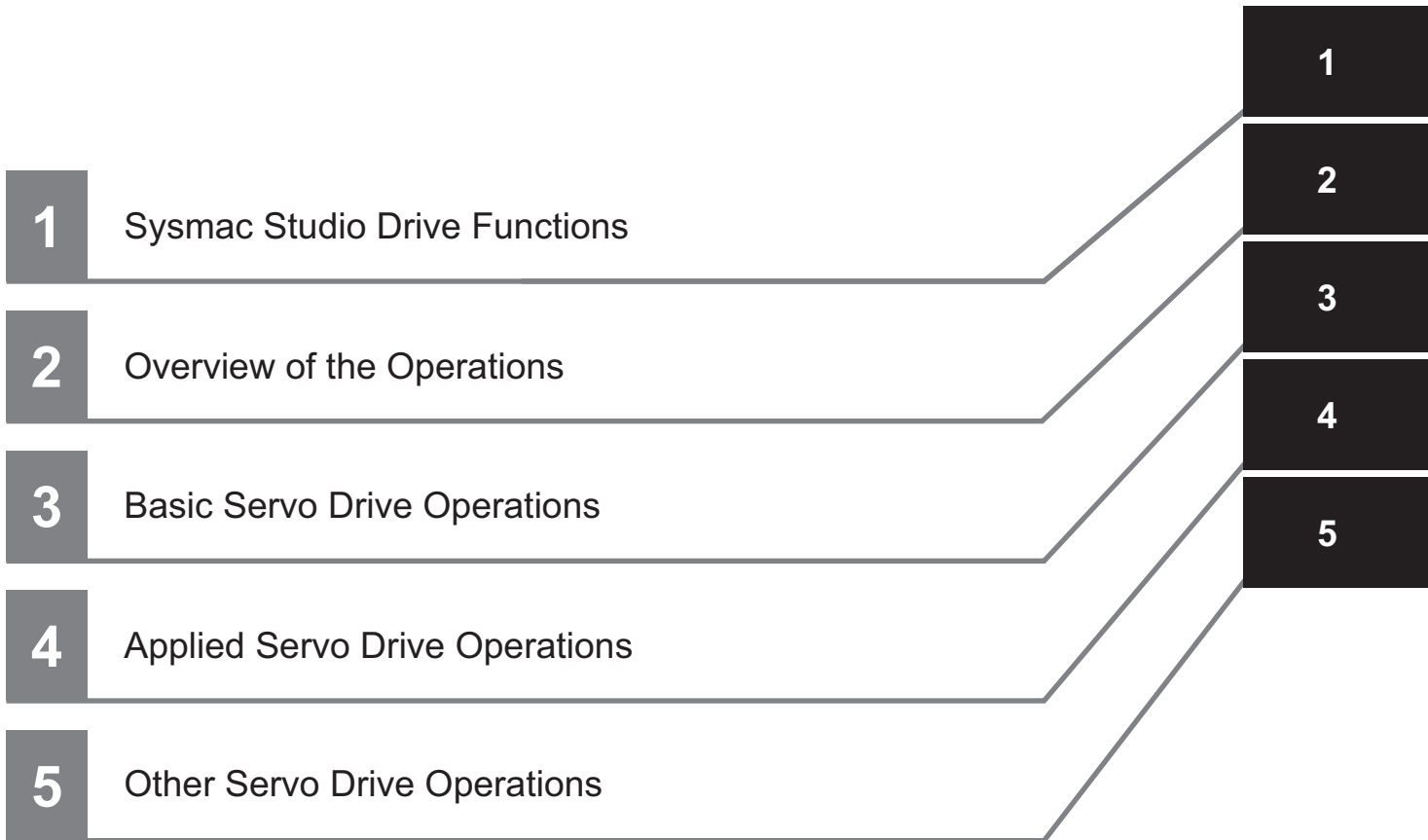

# CONTENTS

---

<b>Introduction .....</b>	<b>1</b>
Intended Audience.....	1
Notice.....	1
<b>Manual Structure .....</b>	<b>2</b>
Special Information.....	3
<b>Sections in this Manual .....</b>	<b>5</b>
<b>Terms and Conditions Agreement.....</b>	<b>8</b>
<b>Safety Precautions .....</b>	<b>9</b>
Definition of Precautionary Information.....	9
Symbols.....	9
<b>Precaution for Safe Use.....</b>	<b>12</b>
<b>Precautions for Correct Use.....</b>	<b>14</b>
<b>Regulations and Standards.....</b>	<b>15</b>
Software Licenses and Copyrights.....	15
<b>Versions .....</b>	<b>16</b>
Unit Versions .....	16
Checking Versions.....	16
Unit Versions and Sysmac Studio Versions .....	18
<b>Related Manuals .....</b>	<b>19</b>
<b>Revision History .....</b>	<b>20</b>

## Section 1      Sysmac Studio Drive Functions

---

<b>1-1 Sysmac Studio Drive Functions.....</b>	<b>1-2</b>
<b>1-2 System Configuration .....</b>	<b>1-3</b>
1-2-1 Connection to Drive.....	1-3
1-2-2 Applicable Drives and Communications Types.....	1-5

## Section 2      Overview of the Operations

---

<b>2-1 Basic Operation Flow.....</b>	<b>2-2</b>
2-1-1 1S Series.....	2-2
2-1-2 G5 Series .....	2-6
<b>2-2 Installation and Uninstallation .....</b>	<b>2-8</b>
<b>2-3 Creating a Project.....</b>	<b>2-9</b>
2-3-1 Using a Drive with an OMRON NJ/NX/NY-series Controller.....	2-9
2-3-2 Using a Drive Independently .....	2-10
<b>2-4 Areas of the Application Window .....</b>	<b>2-12</b>
2-4-1 Overview of the Application Window.....	2-12
2-4-2 Multiview Explorer.....	2-13
2-4-3 Toolbar.....	2-16
<b>2-5 Project Data.....</b>	<b>2-17</b>

2-5-1	Project Management.....	2-17
2-5-2	Project Data.....	2-18
2-5-3	Import and Export.....	2-19
<b>2-6</b>	<b>Functions, Use Cases, and Operation Procedures .....</b>	<b>2-20</b>
2-6-1	1S Series.....	2-20
2-6-2	G5 Series.....	2-22
2-6-3	Function and Operation Procedures for Each Drive.....	2-23
<b>2-7</b>	<b>Online Connection Procedure.....</b>	<b>2-24</b>

## Section 3 Basic Servo Drive Operations

---

<b>3-1</b>	<b>Displaying and Editing Parameters .....</b>	<b>3-2</b>
3-1-1	Displaying and Editing Drive Parameters.....	3-2
3-1-2	Displaying and Editing Multi-drive Parameters (Drive Setting Table).....	3-9
<b>3-2</b>	<b>Auto Tuning .....</b>	<b>3-11</b>
3-2-1	Auto Tuning for 1S Series.....	3-11
3-2-2	Auto Tuning for G5 Series.....	3-12
<b>3-3</b>	<b>Test Run .....</b>	<b>3-18</b>
<b>3-4</b>	<b>Status Monitor .....</b>	<b>3-22</b>
<b>3-5</b>	<b>Troubleshooting .....</b>	<b>3-23</b>
<b>3-6</b>	<b>Data Tracing.....</b>	<b>3-24</b>
<b>3-7</b>	<b>Motors and Encoders.....</b>	<b>3-34</b>
3-7-1	Motor Properties.....	3-34
3-7-2	Encoder Properties.....	3-35
<b>3-8</b>	<b>Setup and Tuning Wizard .....</b>	<b>3-36</b>
3-8-1	Overview.....	3-36
3-8-2	Quick Parameter Setup and I/O Monitor.....	3-37
3-8-3	Test Run and Function Status.....	3-45
3-8-4	Easy Tuning (Single Drive).....	3-48
3-8-5	Easy Tuning (Multiple Drives).....	3-59

## Section 4 Applied Servo Drive Operations

---

<b>4-1</b>	<b>Manual Tuning .....</b>	<b>4-2</b>
4-1-1	1S Series Advanced Tuning.....	4-2
4-1-2	1S Series Manual Tuning (Single Drive).....	4-14
4-1-3	1S Series Manual Tuning (Multiple Drives).....	4-17
4-1-4	G5 Series Manual Tuning.....	4-18
<b>4-2</b>	<b>Other Tuning Functions.....</b>	<b>4-19</b>
4-2-1	FFT.....	4-19
4-2-2	Damping Control.....	4-23
<b>4-3</b>	<b>Motor Settings (only for Linear Motor Type of G5 Series).....</b>	<b>4-27</b>

## Section 5 Other Servo Drive Operations

---

<b>5-1</b>	<b>Initialization of the Drive .....</b>	<b>5-2</b>
<b>5-2</b>	<b>Drive Properties.....</b>	<b>5-3</b>

# Terms and Conditions Agreement

---

## ● WARRANTY

- The warranty period for the Software is one year from the date of purchase, unless otherwise specifically agreed.
- If the User discovers defect of the Software (substantial non-conformity with the manual), and return it to OMRON within the above warranty period, OMRON will replace the Software without charge by offering media or download from OMRON's website. And if the User discovers defect of media which is attributable to OMRON and return it to OMRON within the above warranty period, OMRON will replace defective media without charge. If OMRON is unable to replace defective media or correct the Software, the liability of OMRON and the User's remedy shall be limited to the refund of the license fee paid to OMRON for the Software.

## ● LIMITATION OF LIABILITY

- THE ABOVE WARRANTY SHALL CONSTITUTE THE USER'S SOLE AND EXCLUSIVE REMEDIES AGAINST OMRON AND THERE ARE NO OTHER WARRANTIES, EXPRESSED OR IMPLIED, INCLUDING BUT NOT LIMITED TO, WARRANTY OF MERCHANTABILITY OR FITNESS FOR PARTICULAR PURPOSE. IN NO EVENT, OMRON WILL BE LIABLE FOR ANY LOST PROFITS OR OTHER INDIRECT, INCIDENTAL, SPECIAL OR CONSEQUENTIAL DAMAGES ARISING OUT OF USE OF THE SOFTWARE.
- OMRON SHALL HAVE NO LIABILITY FOR DEFECT OF THE SOFTWARE BASED ON MODIFICATION OR ALTERNATION TO THE SOFTWARE BY THE USER OR ANY THIRD PARTY.
- OMRON SHALL HAVE NO LIABILITY FOR SOFTWARE DEVELOPED BY THE USER OR ANY THIRD PARTY BASED ON THE SOFTWARE OR ANY CONSEQUENCE THEREOF.

## ● APPLICABLE CONDITIONS

USER SHALL NOT USE THE SOFTWARE FOR THE PURPOSE THAT IS NOT PROVIDED IN THE ATTACHED USER MANUAL.

## ● CHANGE IN SPECIFICATION

The software specifications and accessories may be changed at any time based on improvements and other reasons.

## ● ERRORS AND OMISSIONS

The information in this manual has been carefully checked and is believed to be accurate; however, no responsibility is assumed for clerical, typographical, or proofreading errors, or omissions.

# Safety Precautions

## Definition of Precautionary Information

The following notation is used in this manual to provide precautions required to ensure safe usage of the drive functions of Sysmac Studio.

The safety precautions that are provided are extremely important to safety. Always read and heed the information provided in all safety precautions.

The following notation is used.



### WARNING

Indicates a potentially hazardous situation which, if not avoided, could result in death or serious injury. Additionally, there may be severe property damage.



### Caution

Indicates a potentially hazardous situation which, if not avoided, may result in minor or moderate injury, or property damage.



### Precautions for Safe Use

Indicates precautions on what to do and what not to do to ensure safe usage of the product.



### Precautions for Correct Use

Indicates precautions on what to do and what not to do to ensure proper operation and performance.

## Symbols



The circle and slash symbol indicates operations that you must not do. The specific operation is shown in the circle and explained in text. This example indicates prohibiting disassembly.



The triangle symbol indicates precautions (including warnings). The specific operation is shown in the triangle and explained in text. This example indicates a precaution for electric shock.



The triangle symbol indicates precautions (including warnings). The specific operation is shown in the triangle and explained in text. This example indicates a general precaution.





The filled circle symbol indicates operations that you must do.  
 The specific operation is shown in the circle and explained in text.  
 This example shows a general precaution for something that you must do.

 **WARNING**

- Always confirm safety at the destination node before you transfer parameters or data from Sysmac Studio to another node. Not doing so may result in injury.

- When you change the Drive's mode to Test Run mode or RUN mode, the motor operation generator is switched between the host controller and Sysmac Studio. Ensure safety before changing the mode.



- Sometimes you may be unable to stop the motor from your computer. Install an external emergency stop device so that you can stop the motor immediately if needed.



- Confirm the axis number carefully before you perform an operation from Sysmac Studio.





 **Caution**

- Please check the safety of the machines during FFT analysis which requires some drastic movements of motor.  
 To prevent the dangers please monitor the machine and be ready to make the servo OFF any time.  
 Please do not use FFT analysis if there are any risks of damaging machine by moving the motor in wide range.  
 Please do analysis under setting the gain as low as possible.

- Check the parameters for proper execution before you use them for actual operation.

- Don't turn OFF the power supply to the Drive while flash memory is being written. In the worst case, the flash memory may be damaged.

- If the absolute encoder setting function is executed, the multiturn counter and encoder alarm are reset in the absolute serial encoder. When the multiturn counter in the absolute serial encoder is reset to 0, the previously defined machine system changes to a different coordinate system. After the encoder is set normally, reset the zero point of the mechanical system.





---

Confirm that the machine will not be adversely affected before you enable the function to automatically transfer the changed parameters to the Drive.



---

During autotuning or during automatic motor setting for a Linear Motor, the motor operates and the workpiece moves greatly. Provide a means so that you can turn OFF the Servo immediately during autotuning.



---

If you perform FFT analysis, the motor velocity may change drastically. Provide a means so that you can turn OFF the Servo immediately During the FFT analysis.



---

If you use the damping control function, the motor response may change drastically. Provide a means so that you can turn OFF the Servo Drive during the damping control.



---

Conform that the related parameters have been applied to the Drive before performing the automatic motor setting for the Linear Motor in order to prevent unintended operation.



# Precaution for Safe Use

---

## Displaying and Editing Parameters

---

- When you restart a Servo Drive, the ESM state of the Servo Drive will change in the following order: Operational → Init → Operational.
- By the above state transition, the commands to the Servomotor will be stopped. If the device is running, make sure to stop the operation before executing the restart operation.
- When you use the NJ/NX/NY-series, the Controller will enter the minor fault state due to the ESM state transition. Therefore, connect Sysmac Studio to the Controller and execute troubleshooting to reset the error.

## Auto Tuning

---

- The motor operates during the adjustment. Confirm safety at the destination node.
- If abnormal noise or vibration occurs, immediately turn OFF the power supply or the Servo.
- Gain adjustment is automatically performed by the Servo Drive. The motor operates during the adjustment. Follow the following safety precautions.
  - (1) Provide a means to perform an emergency stop (i.e., to turn OFF the power supply). The response may greatly change during the adjustment.
  - (2) Confirm safety around all moving parts. Always confirm that there are no obstacles in the movement range and directions of the motor and that the motor can operate safely. Provide protective measures for unexpected motion.
  - (3) Before you start the adjustment, make sure that the device that is being adjusted is not out of place. Before you start normal operation, make sure to perform homing to reset the position. If home is not reset before the adjustment is performed, the motor may run away, creating a very hazardous condition. Confirm the safety of the system if you use a vertical axis. Make sure that the object that is being adjusted does not fall when the Servo is turned OFF.
  - (4) If vibration or oscillation occurs when auto tuning is performed, manually reduce the gain until the system is stable.
- During auto tuning, the motor operates and the workpiece moves greatly. Provide a means so that you can turn OFF the Servo immediately during auto tuning.
- Always confirm safety at the destination node before you perform easy tuning on multiple Drives.

## Manual Tuning

---

- The advanced tuning for 1S Series is made through a simulation of motor operations. The actual operation may be different from the simulated operations. Ensure safety before the actual operation after the tuning.
- Always confirm safety at the destination node before you perform manual tuning on multiple Drives.

## Test Run

---

- Confirm the axis number carefully before you perform a test run.
- A test run operation involves motor operation. Refer to the operation manual before you execute a test run.

Be particularly careful of the following points.

  - Confirm safety around all moving parts.
  - When you click the start button, the motor begins actual operation at the specified velocity. Begin the motor operation only when you are absolutely sure there is no danger if you start the motor.

- Always have an external emergency stop device available.
- Sometimes you may be unable to stop the motor from your computer. Install an external emergency stop device so that you can stop the motor immediately if needed.
- Only operate the motor when you can clearly confirm the motor operation so that you can react quickly in the case of any danger that may arise due to operation of the motor.
- When you perform a test run via an NJ/NX/NY-series Controller, perform the test run operations after establishing EtherCAT communications.
- A communications error will occur if you attempt to begin operations without EtherCAT communications. Always establish EtherCAT communications first.
- When operation is performed, such data as a travel distance and velocity calculated from the unit conversion settings for the axes assigned on the project file is displayed. Before performing operation, carefully check safety by using units of drive measurement such as command units.
- Precautions during Test Run Operation
  - During test run execution, only Sysmac Studio has any control of the operation. Any commands from motion control instructions are ignored.
  - Make sure that you are operating the correct axis.

## Motors and Encoders

If the absolute encoder setting function is executed, the multiturn counter and encoder alarm are reset in the absolute serial encoder. When the multiturn counter in the absolute encoder is reset to 0, the previously defined machine system changes to a different coordinate system. After the encoder is set normally, reset the zero point of the mechanical system.

## Damping Control

Damping control is automatically performed by the Servo Drive. The motor operates during the adjustment. Follow the following safety precautions.

- Provide a means to perform an emergency stop (i.e., to turn OFF the power supply). The response may greatly change during the adjustment.
- Confirm safety around all moving parts. Always confirm that there are no obstacles in the movement range and directions of the motor and that the motor can operate safely. Provide protective measures for unexpected motion.
- Before you start the adjustment, make sure that the device that is being adjusted is not out of place. Before you start normal operation, make sure to perform homing to reset the position. If home is not reset before the adjustment is performed, the motor may run away, creating a very hazardous condition. Confirm the safety of the system if you use a vertical axis. Make sure that the object that is being adjusted does not fall when the Servo is turned OFF.

## Motor Setup (only for Linear Motor Type of G5 Series)

- After the completion of processing, the related parameters are automatically saved to the non-volatile memory.
- Before moving to the next step, perform the following operations.
  - Go offline with the Servo Drive.
  - Cycle the power supply to the Servo Drive to apply the settings of the parameters that become valid at the startup.
  - If an EtherCAT cable is connected to the Servo Drive, remove it.
  - Go online with the Servo Drive.

# Precautions for Correct Use

---

- Observe the following precautions while the Drive is in Test Run mode.
  - Commands from Sysmac Studio are disabled when you restart the Controller, clear all memory, backup and restore the Controller, or disconnect an EtherCAT slave. Confirm the safety of the system before you perform the operations.
  - If Sysmac Studio goes offline with the Controller or Drive, the Drive enters RUN mode automatically. In RUN mode, commands from Sysmac Studio are disabled, and commands from the Controller are enabled. Confirm the safety of the system before you perform the operation.
  - Do not perform following operations from other computers during a test run for the Drive: restarting the Controller, clearing all memory, restoring the Controller, or disconnecting an EtherCAT slave. Communications between Sysmac Studio and the Drive is disconnected and commands from Sysmac Studio are disabled.
  - If you change more than one Drive to Test Run mode, command transmission time to each Drive will become longer and the Test Run mode may be cancelled.
  - Test Run mode may be cancelled if the personal computer does not satisfy the 'recommended' system requirements for Sysmac Studio because the sending time for each command for drive may become longer than expected. As a result, the drive may detect a disconnection of the cable. The system requirements for recommended environment can be seen at 'Applicable Computers', section 1 'Introduction' in the 'Sysmac Studio Version 1 Operation Manual (W504)'.
  - Be sure to set the value before applying electronic gear ratio in the Drive as the step distance when you perform the operation.
- Do not perform go online to a Drive from more than one copy of Sysmac Studio in one personal computer via USB connection. Communication between Sysmac Studio and the Drive is stopped.

# Regulations and Standards

---

## Software Licenses and Copyrights

- This product incorporates certain third party software. The license and copyright information associated with this software is available at [http://www.fa.omron.co.jp/nj\\_info\\_e/](http://www.fa.omron.co.jp/nj_info_e/).
- This software uses knowledge media technology that was developed by the Meme Media Laboratory (VBL) of Hokkaido University.

# Versions

## Unit Versions

Hardware revisions and unit versions are used to manage the hardware and software in NJ/NX-series Units and EtherCAT slaves. The hardware revision or unit version is updated each time there is a change in hardware or software specifications. Even when two Units or EtherCAT slaves have the same model number, they will have functional or performance differences if they have different hardware revisions or unit versions.

This section describes NJ/NX-series CPU Units and EtherCAT slaves as examples.

## Checking Versions

You can check versions on the ID information indications or with the Sysmac Studio.

### Checking Unit Versions on ID Information Indications

The unit version is given on the ID information indication on the side of the product.

The ID information on an NX-series NX701-□□□□ CPU Unit is shown below.

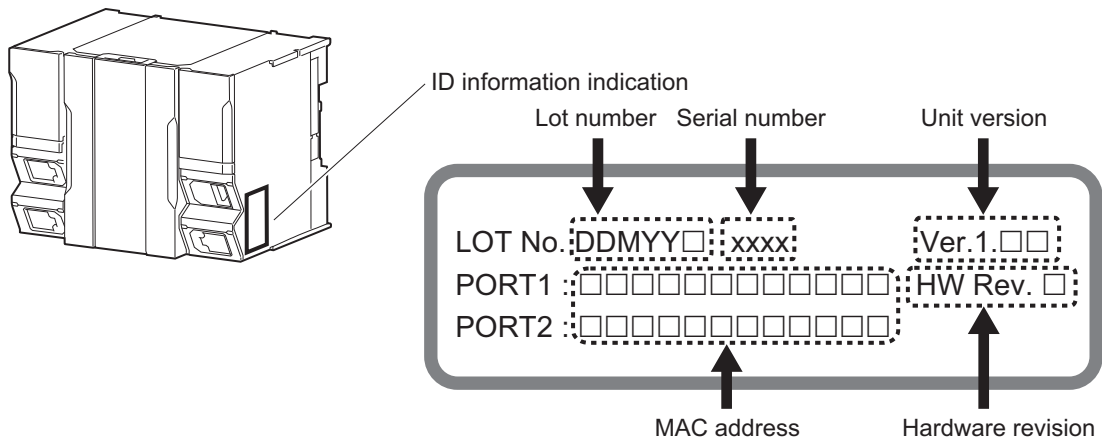

Note The hardware revision is not displayed for the Unit that the hardware revision is in blank.

The ID information on an NJ-series NJ501-□□□□ CPU Unit is shown below.

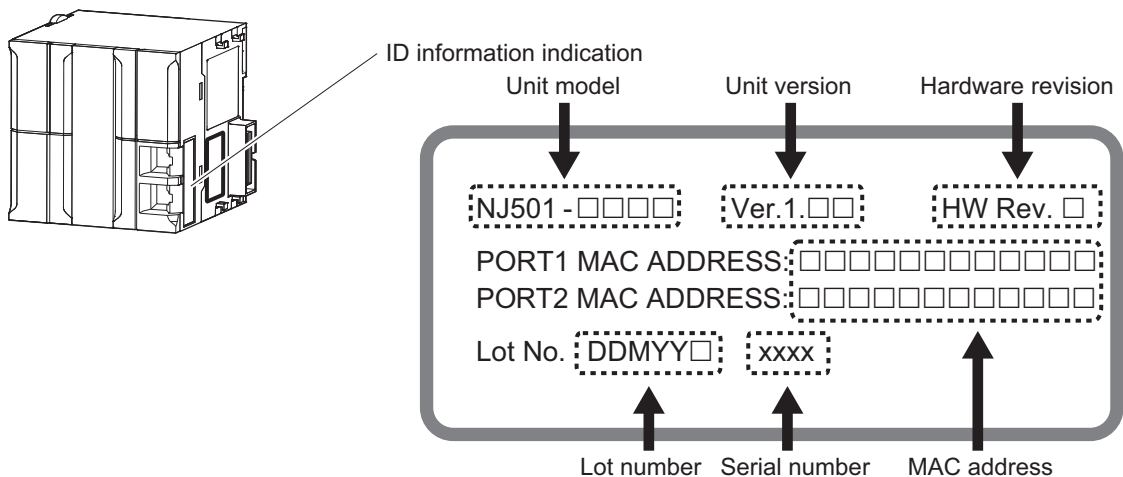

Note The hardware revision is not displayed for the Unit that the hardware revision is in blank.

## Checking Unit Versions with the Sysmac Studio

You can use the Production Information Dialog Box while the Sysmac Studio is online to check the unit version of a Unit.

You can check the unit version of the following Units.

- CPU Units
- CJ-series Special I/O Units and CPU Bus Units
- EtherCAT slaves

The unit versions of CJ-series Basic I/O Units cannot be checked from the Sysmac Studio.

Refer to the *Sysmac Studio Version 1 Operation Manual* (Cat. No. W504) for details on the Unit production information displays.

### ● NX-series CPU Units

- 1 Right-click **CPU Rack** under **Configurations and Setup – CPU/Expansion Racks** in the Multi-view Explorer and select **Display Production Information**.

The Production Information Dialog Box is displayed.

The unit version is displayed after *Ver.* to the right of the Unit model number.

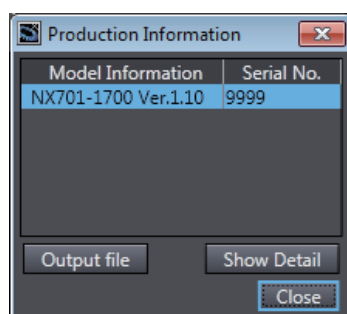

### ● NJ-series CPU Units and CJ-series Units

- 1 Double-click **CPU/Expansion Racks** under **Configurations and Setup** in the Multiview Explorer. Or, right-click **CPU/Expansion Racks** under **Configurations and Setup** and select **Edit** from the menu.

The Unit Editor is displayed.

- 2 Right-click any open space in the Unit Editor and select **Production Information**.

The Production Information Dialog Box is displayed.

The unit version is displayed after *Ver.* to the right of the Unit model number.

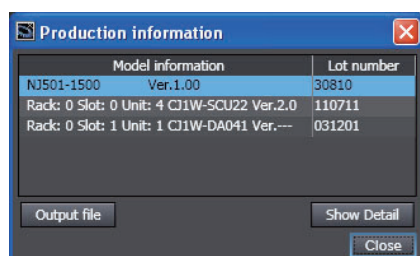

### ● EtherCAT Slaves

- 1 Double-click **EtherCAT** under **Configurations and Setup** in the Multiview Explorer. Or, right-click **EtherCAT** under **Configurations and Setup** and select **Edit** from the menu.

The EtherCAT Tab Page is displayed.

- 2 Right-click the master on the EtherCAT Tab Page and select **Display Production Information**. The Production Information Dialog Box is displayed. The unit version is displayed after Rev. to the right of the Unit model number.

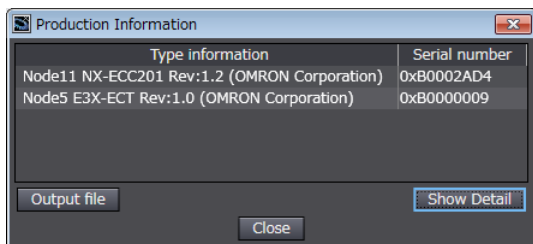

**Additional Information**

- Refer to the manual for the specific Unit for the unit versions of the CPU Units to which the database connection service and other functions were added, as well as for the unit versions of the Communications Coupler Units, NX Units, and Safety Control Units.
- This manual sometimes refers to the unit version of the CPU Unit as the unit version of the Controller.

## Unit Versions and Sysmac Studio Versions

The functions that are supported by a Unit depend on its unit version. The version of Sysmac Studio that supports the functions that were added for an upgrade is required to use those functions. Refer to the *NJ/NX-series CPU Unit Software User's Manual* (Cat. No. W501) for the relationship between the unit versions of the NJ/NX-series CPU Units and the Sysmac Studio versions, and for the functions that are supported by each unit version. Refer to the relevant manuals for the Communications Coupler Unit and NX Units for differences in the functional support provided by each unit version.



# Related Manuals

The following manuals are related. Use these manuals for reference.

Manual name	Cat. No.	Model numbers	Application	Description
Sysmac Studio Drive Functions Operation Manual (this manual)	I589	SYS-MAC-SE2□□□	Learning about the drive functions of Sysmac Studio.	Describes the operating procedures for the drive functions of Sysmac Studio.
Sysmac Studio Version 1 Operation Manual	W504	SYS-MAC-SE2□□□	Learning about the operating procedures and functions of Sysmac Studio besides the drive functions.	Describes the operating procedures for other functions of Sysmac Studio.
1S-series AC Servomotors and Servo Drives User's Manual (with Built-in EtherCAT® Communications)	I586	R88M-1□, R88D-1SN□-ECT	Learning about the 1S-series AC Servomotors and Servo Drives with built-in EtherCAT communications	Describes the hardware, setting methods, and functions of 1S-series AC Servomotors and Servo Drives with built-in EtherCAT communications.
1S-Series AC Servomotors and Servo Drives User's Manual (with Built-in EtherCAT® Communications and Safety Functionality)	I621	R88M-1AL□/1AM□, R88D-1SAN□-ECT	Learning about the 1S-series AC Servomotors and Servo Drives with built-in EtherCAT communications and Safety Functionality.	Describes the hardware, setting methods, and functions of 1S-series AC Servomotors and Servo Drives with built-in EtherCAT communications and Safety Functionality.
G5-series AC Servomotors and Servo Drives User's Manual (with Built-in EtherCAT® Communications)	I576	R88M-K□, R88D-KN□-ECT	Learning about the G5-series AC Servomotors and Servo Drives with built-in EtherCAT communications.	Describes the hardware, setting methods, and functions of G5-series AC Servomotors and Servo Drives with built-in EtherCAT communications.
G5-series Linear Motors/Servo Drives User's Manual (with Built-in EtherCAT® Communications)	I577	R88L-EC-□, R88D-KN□-ECT-L	Learning about the G5-series Linear Motors and Servo Drives with built-in EtherCAT communications.	Describes the hardware, setting methods, and functions of G5-series Linear Motors and Servo Drives with built-in EtherCAT communications.
CJ1W-NC□81/□82 Position Control Unit User's Manual	W487	CJ1W-NC□81/□82	Learning about the CJ-series Position Control Unit CJ1W-NC□8□.	Describes the hardware, setting methods, and functions of CJ1W-NC□8□ Position Control Unit.

# Revision History

---

A manual revision code appears as a suffix to the catalog number on the front and back covers of the manual.

**Cat. No. I589-E1-06**

↑  
Revision code

Revision code	Date	Revised content
01	July 2016	Original production
02	April 2017	Revisions for an upgrade to Sysmac Studio version 1.18.
03	October 2017	Revisions for an upgrade to Sysmac Studio version 1.20.
04	April 2018	Revisions for an upgrade to Sysmac Studio version 1.22.
05	July 2019	Revisions for an upgrade to Sysmac Studio version 1.29.
06	April 2020	Revisions for an upgrade to Sysmac Studio version 1.40.

# 1

## Sysmac Studio Drive Functions

This section provides an overview of the Sysmac Studio drive functions and describes its features, system configuration, and use cases.

---

<b>1-1</b>	<b>Sysmac Studio Drive Functions</b>	<b>1-2</b>
<b>1-2</b>	<b>System Configuration</b>	<b>1-3</b>
1-2-1	Connection to Drive	1-3
1-2-2	Applicable Drives and Communications Types	1-5

# 1-1 Sysmac Studio Drive Functions

---

Sysmac Studio Automation Software provides an integrated development environment to set up, program, debug, and maintain SYSMAC NJ/NX/NY-series Controllers and other Machine Automation Controllers, as well as EtherCAT slaves. Sysmac Studio offers various functions for specific Drives installed as EtherCAT slaves, for example, parameter settings, transfer, and comparison as well as test runs, tuning, monitoring, and data tracing. These functions are collectively called “drive functions”.

This manual describes the operation procedures of Sysmac Studio drive functions.

## Support for OMRON Drives

---

1S-series Servo Drives and G5-series Servo Drives are supported.

## Easy and Secure Drive Parameter Settings

---

Parameters can be selected by specifying a category or filtering the list.

You can customize a category to make your own favorite category.

## Efficient Drive Setup and Tuning Navigated by the Setup and Tuning Wizard (1S Series Only)

---

For 1S-series Drives, the Setup and Tuning wizard is provided to perform a series of operations from basic parameter settings<sup>\*1</sup> and transfer, test run, and tuning to data tracing. With the wizard, you can reduce the time required for drive settings and tuning.

\*1. With the Setup and Tuning wizard for a 1S-series Drive, you can assign functions to external I/O signals (i.e., control I/O connectors) easily while checking the connector pin numbers and arrangement diagram.

## Support of Various Tuning Methods (1S Series Only)

---

For 1S Series, three kinds of tuning methods are provided; easy tuning, advanced tuning, and manual tuning.

In Easy tuning and Manual tuning, tuning can be simultaneously performed on multiple Drives.

- Easy tuning: Gains and filters are automatically adjusted by repeating motor operations. Use this method when you want to perform the tuning easily.
- Advanced tuning: You can adjust gains and filters by minimum motor operations through a simulation. Gain and filter settings can be adjusted individually.
- Manual tuning: You can adjust gains and filters at the same time by editing only one parameter.

# 1-2 System Configuration

This section describes the system configuration for the functions available when *Drive* is selected in a Sysmac Studio project.

## 1-2-1 Connection to Drive

Sysmac Studio can be connected to a Drive by the following four methods.

- Direct connection to a Drive via USB
- Connection to a Drive on an EtherCAT network through an NJ/NX-series CPU Unit connected via USB or Ethernet
- Connection to a Drive on an EtherCAT network through a Programmable Multi-Axis Controller connected via Ethernet
- Connection to a Drive on an EtherCAT network through a CJ-series CPU unit connected via USB or Ethernet, equipped with a CJ1W-NC□8□ Position Control Unit

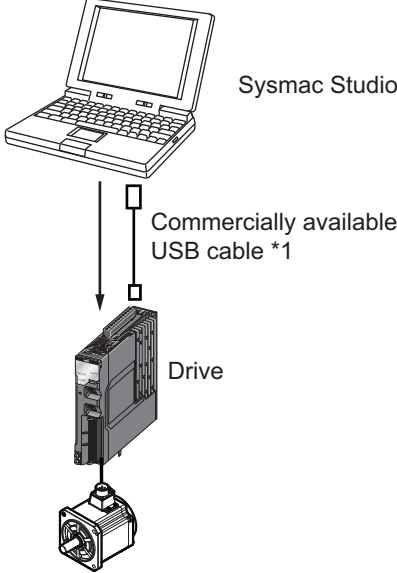
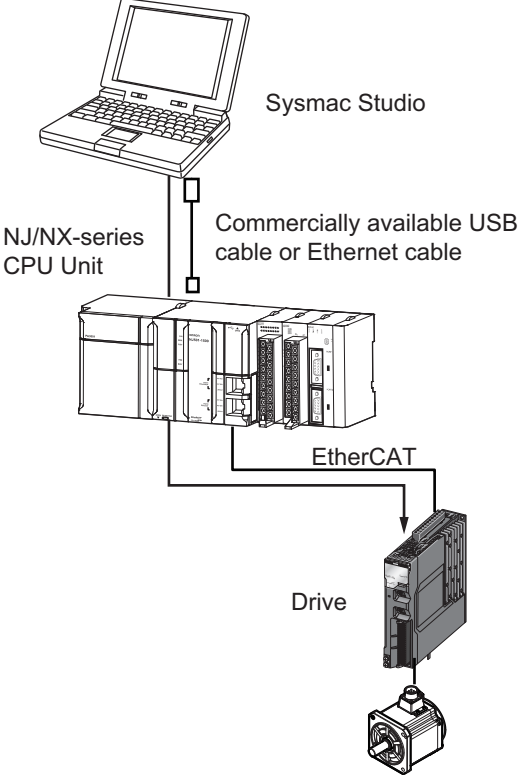
Connection method	●Direct connection via USB	●EtherCAT connection via an NJ/NX-series CPU Unit
Drive	1S Series and G5 Series	
Connection diagram	 <p>The diagram shows a laptop labeled 'Sysmac Studio' connected to a 'Drive' unit. A 'Commercially available USB cable *1' connects the laptop to the drive. Below the drive is a servo motor.</p> <p>*1. Refer to the manuals of each Servo Drive for the USB cable.</p>	 <p>The diagram shows a laptop labeled 'Sysmac Studio' connected to an 'NJ/NX-series CPU Unit'. A 'Commercially available USB cable or Ethernet cable' connects the laptop to the CPU unit. The CPU unit is connected to a 'Drive' via an 'EtherCAT' network. Below the drive is a servo motor.</p>

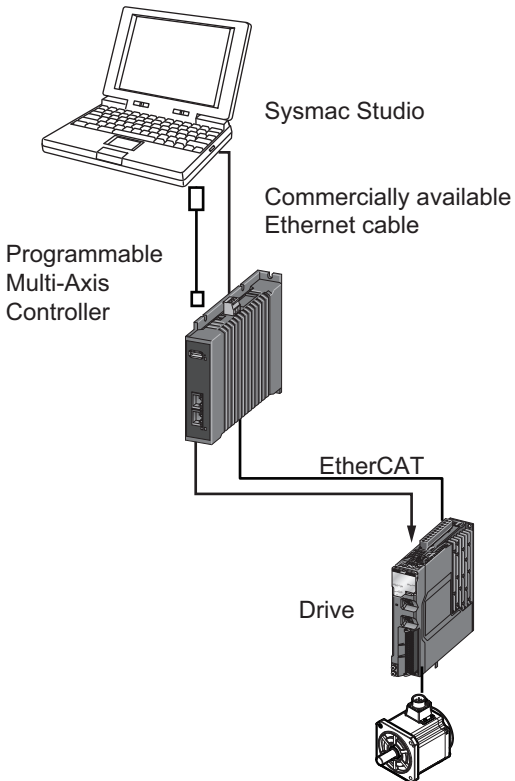
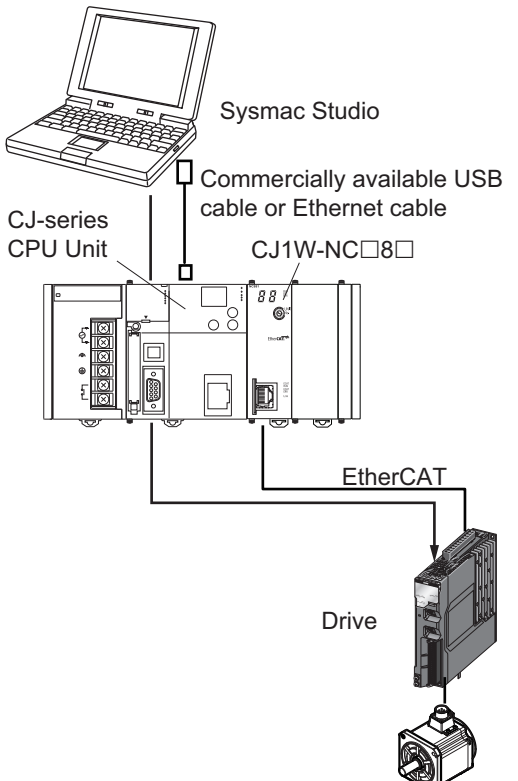
Connection method	●EtherCAT connection via a Programmable Multi-Axis Controller	●EtherCAT connection via CJ1W-NC□8□ Position Controller
Drive	1S Series and G5 Series	1S Series
Connection diagram	 <p>Diagram illustrating the EtherCAT connection via a Programmable Multi-Axis Controller. A laptop labeled "Sysmac Studio" is connected to a "Programmable Multi-Axis Controller" using a "Commercially available Ethernet cable". The controller is connected to a "Drive" via an "EtherCAT" cable, which is then connected to a motor.</p>	 <p>Diagram illustrating the EtherCAT connection via CJ1W-NC□8□ Position Controller. A laptop labeled "Sysmac Studio" is connected to a "CJ-series CPU Unit" using a "Commercially available USB cable or Ethernet cable". The CPU Unit is connected to a "CJ1W-NC□8□" position controller, which is then connected to a "Drive" via an "EtherCAT" cable, which is then connected to a motor.</p>

Refer to 2-7 *Online Connection Procedure* on page 2-24 for the online connection procedure with the Drive.

## 1-2-2 Applicable Drives and Communications Types

Sysmac Studio supports the following Drives. Each Drive supports the communications given in the table.

Device category	Drive name	Type	Model	Reference manual	Communications with Sysmac Studio			
					Direct connection via USB	EtherCAT connection via an NJ/NX/NY-series CPU Unit	EtherCAT connection via Programmable Multi-Axis Controller	EtherCAT connection via CJ1W-NC □8□ Position Controller
Servo Drive	AC Servo Drive	1S-series AC Servomotors and Servo Drives with Built-in EtherCAT Communications	R88D-1SN□-ECT	I586	Possible	Possible	Possible	Possible
		1S-Series AC Servomotors and Servo Drives with Built-in EtherCAT Communications and Safety Functionality	R88D-1SAN□-ECT	I621				Possible
		G5-series AC Servomotors and Servo Drives with Built-in EtherCAT Communications	R88D-KN□-ECT	I576				Not possible
	Linear Drive	G5-series Linear Motors and Servo Drives with Built-in EtherCAT Communications	R88D-KN□-ECT-L	I577				Not possible





# 2

## Overview of the Operations

This section describes the basic drive operation flow and user interfaces of Sysmac Studio.

---

<b>2-1 Basic Operation Flow</b>	<b>2-2</b>
2-1-1 1S Series	2-2
2-1-2 G5 Series	2-6
<b>2-2 Installation and Uninstallation</b>	<b>2-8</b>
<b>2-3 Creating a Project</b>	<b>2-9</b>
2-3-1 Using a Drive with an OMRON NJ/NX/NY-series Controller	2-9
2-3-2 Using a Drive Independently	2-10
<b>2-4 Areas of the Application Window</b>	<b>2-12</b>
2-4-1 Overview of the Application Window	2-12
2-4-2 Multiview Explorer	2-13
2-4-3 Toolbar	2-16
<b>2-5 Project Data</b>	<b>2-17</b>
2-5-1 Project Management	2-17
2-5-2 Project Data	2-18
2-5-3 Import and Export	2-19
<b>2-6 Functions, Use Cases, and Operation Procedures</b>	<b>2-20</b>
2-6-1 1S Series	2-20
2-6-2 G5 Series	2-22
2-6-3 Function and Operation Procedures for Each Drive	2-23
<b>2-7 Online Connection Procedure</b>	<b>2-24</b>

## 2-1 Basic Operation Flow

This section describes the basic Sysmac Studio operation flows for the Drives.

### 2-1-1 1S Series

This section gives the basic operation flow for 1S Series.

#### Creating a Project

Procedure	Online	Offline	Operation	Reference
Starting Sysmac Studio and creating a new project on the start page.	Possible	Possible	<ul style="list-style-type: none"> <li>Setup and Tuning for Independent Drives: Select <b>New Project</b>, and select <b>Drive</b> in the <b>Category</b> field and the applicable model number in the <b>Device</b> field. Then, click the <b>Create</b> button.</li> <li>Using the Drive with an OMRON NJ/NX/NY-series Controller: After creating a project for the Controller, register the applicable model to the EtherCAT configuration. (Refer to the <i>Sysmac Studio Version 1 Operation Manual</i> (Cat. No. W504) for details.)</li> <li>Using the Drive with an OMRON Programmable Multi-Axis Controller: Select <b>New Project</b>, and select <b>Drive</b> in the <b>Category</b> field and the applicable model number in the <b>Device</b> field. Then, click the <b>Create</b> button. Once the drive project is created, right-click on the drive and select <b>Communications Setup</b> from the menu. Once opened, configure the <b>Remote connection via Programmable Multi-Axis Controller (EtherCAT)</b>.</li> <li>Using the Drive with an OMRON CJ-series CPU Unit equipped with CJ1W-NC□8□ Position Control Unit: Select <b>New Project</b>, and select <b>Drive</b> in the <b>Category</b> field and the applicable model number in the <b>Device</b> field. Then, click the <b>Create</b> button. Once the drive project is created, right-click on the drive and select <b>Communications Setup</b> from the menu. Once opened, configure the <b>Remote connection via CJ1W-NC[8] Position Controller (EtherCAT)</b>.</li> </ul>	2-3 <i>Creating a Project</i> on page 2-9

## Setup and Tuning through Troubleshooting

Procedure		Online	Offline	Operation	Reference
Step 1:	Going online/offline with the Drive	Possible	Possible	Select <b>Online</b> or <b>Offline</b> .	2-7 <i>Online Connection Procedure</i> on page 2-24
↓					
Step 2:	Startup	---	---	Select <b>Setup and Tuning</b> .	3-8 <i>Setup and Tuning Wizard</i> on page 3-36
	1. Setup of an absolute encoder	Possible	---	Select <b>Quick Parameter Setup and I/O Monitor</b> in the Setup and Tuning wizard.	3-8-2 <i>Quick Parameter Setup and I/O Monitor</i> on page 3-37
	2. Function assignment to external I/O signals	Possible	Possible		
	3. Test run	Possible	---		
	4. Tuning	Possible	---	Select <b>Setup and Tuning</b> .	
	Note Refer to <i>Tuning Method Selection Flow</i> on page 2-5 below for how to select a tuning method.				
	Easy Tuning	Possible	---	Select <b>Easy Tuning</b> in the Setup and Tuning wizard.	3-8-4 <i>Easy Tuning (Single Drive)</i> on page 3-48
	Advanced Tuning	Possible	---	Select <b>Advanced Tuning</b> in the Setup and Tuning wizard.	4-1 <i>Manual Tuning</i> on page 4-2
	Manual Tuning	Possible	---	Select <b>Manual Tuning</b> in the Setup and Tuning wizard.	
↓					
Step 3:	Detailed Settings and Tuning				
	1. Editing the parameters (except for the function assignment to external I/O signals)	Possible	Possible	Double-click <b>Parameters</b> .	3-1 <i>Displaying and Editing Parameters</i> on page 3-2
	2. Test run	Possible	---	Select <b>Test Run</b> .	3-3 <i>Test Run</i> on page 3-18
	3. Data tracing	Possible	---	Right-click <b>Data Trace Settings</b> and select <b>Add - Data Trace</b> from the menu. Then, double-click the data trace created.	3-6 <i>Data Tracing</i> on page 3-24
	4. FFT (Fast Fourier Transform) analysis	Possible	---	Double-click <b>FFT</b> .	4-2-1 <i>FFT</i> on page 4-19

Procedure		Online	Offline	Operation	Reference
5.	Damping control	Possible	---	Select <b>Damping Control</b> .	<i>4-2-2 Damping Control</i> on page 4-23
↓					
Step 4:	Status monitoring and troubleshooting	Possible	---	Select <b>Status Monitor</b> or <b>Troubleshooting</b> .	<i>3-4 Status Monitor</i> on page 3-22 <i>3-5 Troubleshooting</i> on page 3-23

## Tuning Method Selection Flow

Follow this flow to select a tuning method.

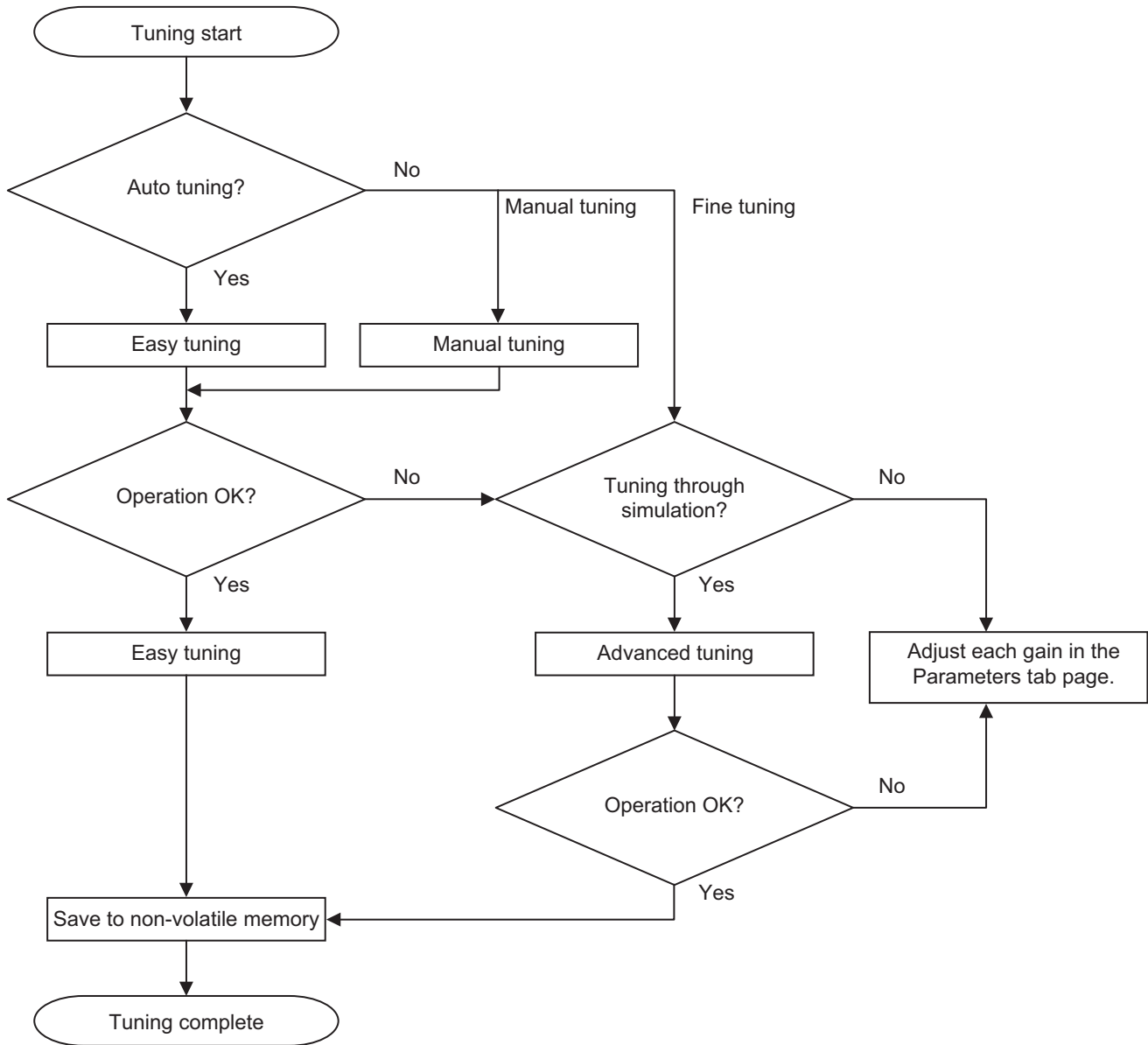

## 2-1-2 G5 Series

This section gives the basic operation flow for G5 Series.

### Creating a Project

Procedure	Online	Offline	Operation	Reference
Starting Sysmac Studio and creating a project on the start page.	Possible	Possible	<ul style="list-style-type: none"> <li>• Setup and Tuning for Independent Drives: Select <b>New Project</b>, and select <b>Drive</b> in the <b>Category</b> field and the applicable model number in the <b>Device</b> field. Then, click the <b>Create</b> button.</li> <li>• Using the Drive with an OMRON NJ/NX/NY-series Controller: After creating a project for the Controller, register the applicable model to the EtherCAT configuration. (Refer to the <i>Sysmac Studio Version 1 Operation Manual</i> (Cat. No. W504) for details.)</li> <li>• Using the Drive with an OMRON Programmable Multi-Axis Controller: Select <b>New Project</b>, and select <b>Drive</b> in the <b>Category</b> field and the applicable model number in the <b>Device</b> field. Then, click the <b>Create</b> button. Once the drive project is created, right-click on the drive and select <b>Communications Setup</b> from the menu. Once opened, configure the <b>Remote connection via Programmable Multi-Axis Controller (EtherCAT)</b>.</li> </ul>	2-3 <i>Creating a Project</i> on page 2-9

## Setup and Tuning through Troubleshooting

Procedure	Online	Offline	Operation	Reference
Step 1: Going online/offline with the Drive To be also executed in the subsequent steps as necessary.	Possible	Possible	Select <b>Online</b> * <sup>1</sup> or <b>Offline</b> .	2-7 <i>Online Connection Procedure</i> on page 2-24
Step 2: Editing the parameters	Possible	Possible	Double-click <b>Parameters</b> .	3-1 <i>Displaying and Editing Parameters</i> on page 3-2
Step 3: Test run (To be also executed in the subsequent steps as necessary)	Possible	---	Select <b>Test Run</b> .	3-3 <i>Test Run</i> on page 3-18
Step 4: Setup of an absolute encoder	Possible	---	Select <b>Motor and Encoder</b> .	3-7 <i>Motors and Encoders</i> on page 3-34
Step 5: Data tracing (To be also executed in the subsequent steps as necessary)	Possible	---	Right-click <b>Data Trace Settings</b> and select <b>Add - Data Trace</b> from the menu. Then, double-click the data trace created.	3-6 <i>Data Tracing</i> on page 3-24
Step 6: Auto tuning Easy tuning	Possible	---	Select <b>Auto Tuning</b> .	3-2-2 <i>Auto Tuning for G5 Series</i> on page 3-12
Step 7: FFT (Fast Fourier Transform) analysis and damping control, as necessary	Possible	---	Double-click <b>FFT</b> . Select <b>Damping Control</b> .	4-2-1 <i>FFT</i> on page 4-19
Step 8: Status monitoring (To be also executed in the earlier steps as necessary) and troubleshooting	Possible	---	Select <b>Status Monitor</b> or <b>Troubleshooting</b> .	3-4 <i>Status Monitor</i> on page 3-22 3-5 <i>Troubleshooting</i> on page 3-23

\*1. In the EtherCAT connection via an NJ/NX/NY-series CPU Unit, when Sysmac Studio goes online with the CPU Unit, the online status with each Drive is established automatically.

## 2-2 Installation and Uninstallation

---

Refer to the *Sysmac Studio Version 1 Operation Manual* (Cat. No. W504).



## 2-3 Creating a Project

This section describes how to create a project including Drives in Sysmac Studio.

Use the following two methods to register a Drive to a project in Sysmac Studio.

- Registering a Drive as an EtherCAT slave in a project
- Registering an independent Drive in a project

### 2-3-1 Using a Drive with an OMRON NJ/NX/NY-series Controller

When you use a Drive with an OMRON NJ/NX/NY-series Controller, you register the Drive as an EtherCAT slave in a project. Register the applicable Drive to the EtherCAT configuration in the Controller project.

- 1** When creating a new project, select **Controller** in the **Category** field of the **Select Device** area. Then, select an NJ/NX/NY-series CPU Unit in the **Device** field.  
Or, add a Controller to an existing project and select an NJ/NX/NY-series CPU Unit as **Device**.
- 2** Select the Controller that was registered in the previous step and register the applicable Drive in the EtherCAT configuration tab page.

Refer to *2-5 Project Data* on page 2-17 for positioning of the drive-related data in the Sysmac Studio project. Refer to *EtherCAT Configuration and Setup of the Sysmac Studio Version 1 Operation Manual* (Cat. No. W504) for details of the registration in the EtherCAT configuration tab page.

### Changing the Model of a Drive

You can change the model of a registered Drive.

- 1** Right-click a Drive on the EtherCAT Tab Page and select **Change Model**.  
The Drives that you can change to are displayed in the Change Model dialog box.
- 2** Select the Drive to change to and then click the **OK** button.  
A dialog box that alerts you to the change of the model is displayed.
- 3** Click the **OK** button.  
The Drive is changed to the selected model and unit version.



#### Precautions for Correct Use

- For G5-series unit version earlier than 2.0 (excluding Linear Servo Drives) and between different types of Servo Drives, you cannot change the model.
- Any settings in the Drive before the change that are not supported by the Drive after the change will be lost when you change the model.

## 2-3-2 Using a Drive Independently

An independent Drive is registered to the Drive group in a project. Use the following two methods for registration:

- Selecting **Drive** in the **Category** field of the **Select Device** area when you create a new project
- Adding the **Drive** to an existing project

Refer to *2-5 Project Data* on page 2-17 for positioning of the drive-related data in the Sysmac Studio project.

Refer to the *Sysmac Studio Version 1 Operation Manual* (Cat. No. W504) for basic operations of Sysmac Studio.

### Selecting a Drive as a Device when Creating a New Project

When creating a new project file, select a Drive as a device.

- 1 Click the **New Project** button in the project window.
- 2 In the Project Properties dialog box, enter values in the **Project name**, **Author** (optional) and **Comment** (optional) fields and select the following in the **Category** and **Device** fields in the **Select Device** area.

Field	Item to select
Category	Drive
Device	Applicable Drive model

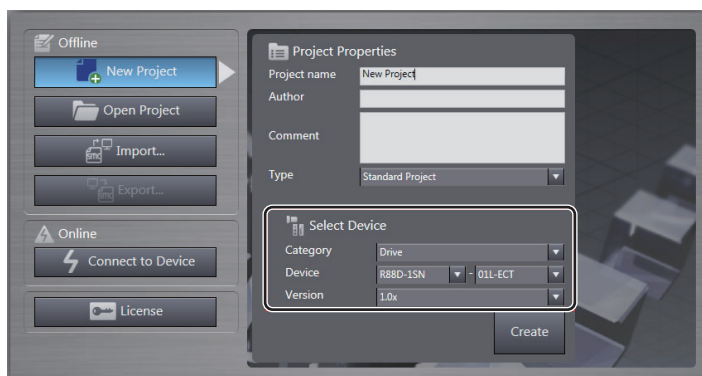

**Note** When the computer with Sysmac Studio running is directly connected to a Drive via USB, a new project can be automatically created for the connected Drive. To do so, click the **Connect to Device** button without opening a project in the above start page of Sysmac Studio. Refer to *Going Online from the Start Page of Sysmac Studio* on page 2-26 of *2-7 Online Connection Procedure* on page 2-24 for details.

- 3 Click the **Create** button at the bottom right of the **Select Device** area.  
A new project is created and the following window is displayed.

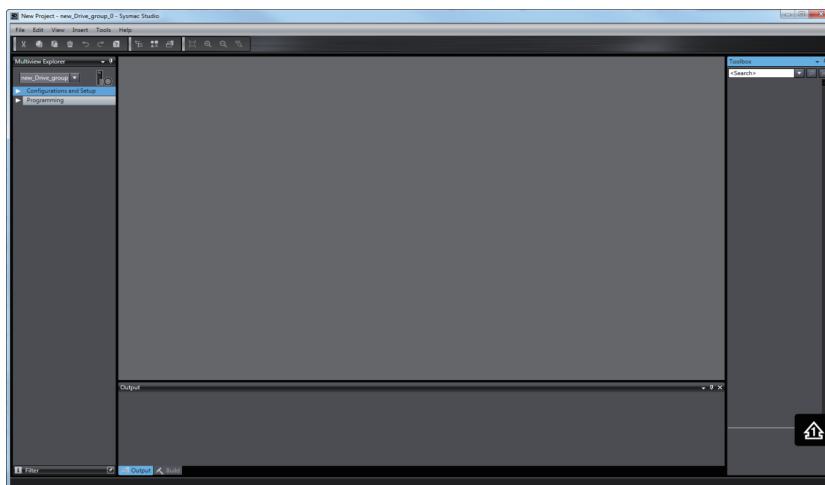

## Adding a Drive to an Existing Project

- 1 Select **Drive** from the **Insert** menu in the main menu bar.  
Or, right-click **Device Group** in the Multiview Explorer and select **Add** from the menu.
- 2 The following **Add Device** dialog box is displayed. Select the applicable model number.

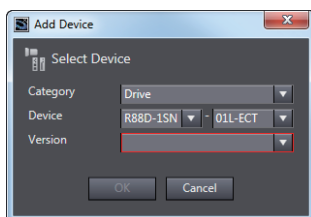

- 3 Click the **OK** button. The selected Drive is registered.

## Changing the Model of a Registered Drive

- 1 Right-click a registered Drive and select **Change Device** from the menu.
- 2 The drive selection dialog box is displayed. Change the Drive to the model that you want to set.
- 3 Click the **OK** button. If the following dialog box is displayed, confirm that no problem will occur, and then click the **Yes** Button.

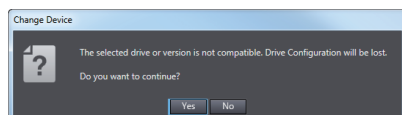

## 2-4 Areas of the Application Window

This section gives the names of the parts specific to Sysmac Studio.

### 2-4-1 Overview of the Application Window

When you open a project, the following application window is displayed.

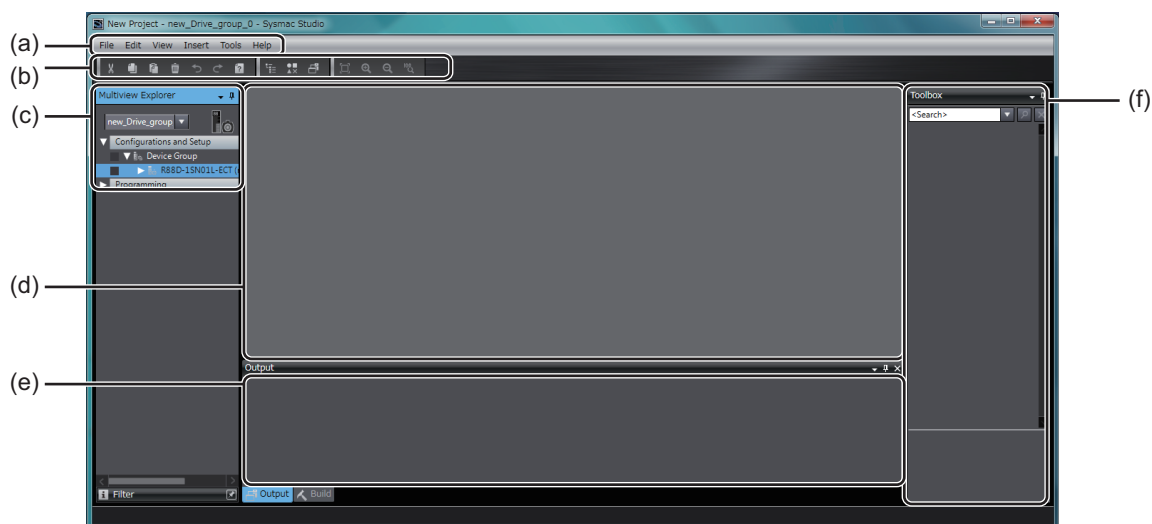

No.	Name	Description
(a)	Menu bar	Menu names are displayed in this bar.
(b)	Toolbar	Buttons and icons are displayed in this bar.
(c)	Multiview Explorer	This pane is your access point for all Sysmac Studio data.
(d)	Edit pane	The edit pane is used to display and edit the data for any of the items.
(e)	Output tab page	Operation execution status and errors are displayed in this tab page.
(f)	Toolbox	Not used.
	Properties pane	The data trace and FFT properties are displayed in this pane.

## 2-4-2 Multiview Explorer

This pane is your access point for all Drive data.

### Drive Display Position and Method

- **Drives Independently Registered in the Project**

For each Drive, its model number is displayed under **Configurations and Setup - Device Group**.

- **Drives Registered as EtherCAT Slaves in the Project**

For each Drive, its node address, and model number followed by the Drive name in parentheses are displayed under **Configurations and Setup - EtherCAT**.

### Operation Procedure for Each Function

The operation procedure of Sysmac Studio differs according to the functions.

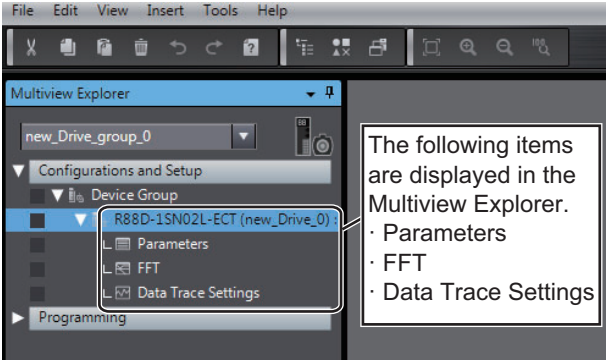
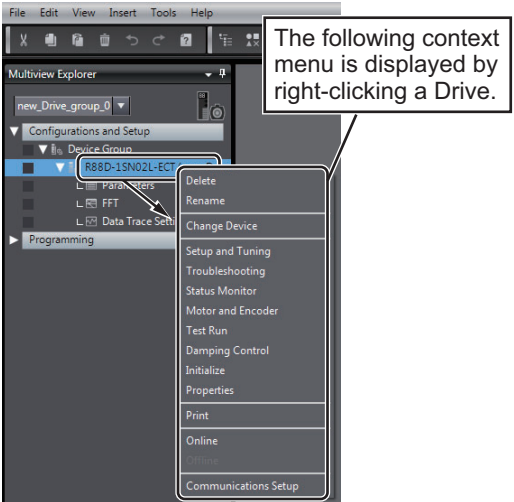
Category	Functions (item name/menu name)	Operation
Functions executed from the Multiview Explorer	<ul style="list-style-type: none"> <li>• Parameters</li> <li>• FFT</li> <li>• Data Trace Settings</li> </ul>	<p>Select an item from the tree structure in the Multiview Explorer.</p>  <p>The following items are displayed in the Multiview Explorer.</p> <ul style="list-style-type: none"> <li>• Parameters</li> <li>• FFT</li> <li>• Data Trace Settings</li> </ul>
Functions executed from the context menu <sup>*1</sup>	<ul style="list-style-type: none"> <li>• Setup and Tuning (1S Series only)</li> <li>• Auto Tuning (G5 Series only (both the AC servomotor type and linear motor type))</li> <li>• Troubleshooting</li> <li>• Status Monitor</li> <li>• Motor and Encoder</li> <li>• Test Run</li> <li>• Damping Control</li> <li>• Initialize</li> <li>• Properties</li> </ul>	<p>Right-click the Drive and select a command from the menu.</p>  <p>The following context menu is displayed by right-clicking a Drive.</p> <p>Refer to the following page for the differences between Drive types.</p>

\*1. Context menu displayed by right-clicking each Drive type

The context menu displayed by right-clicking each Drive differs by the Drive types as shown below.

The displayed menu also differs according to how the Drive is registered in the project, i.e., whether the Drive is registered as an EtherCAT slave or the Drive is independently registered in the project.

Drive type	1S Series	G5 Series (Except for linear motor type)	G5 Series (Linear motor type)
Registered as an EtherCAT slave in the project	<ul style="list-style-type: none"> <li>Setup and Tuning</li> <li>Troubleshooting</li> <li>Status Monitor</li> <li>Motor and Encoder</li> <li>Test Run</li> <li>Damping Control</li> <li>Initialize</li> <li>Properties</li> <li>Print</li> <li>Online</li> <li>Offline</li> <li>Direct Connection (USB) ▶</li> </ul>	<ul style="list-style-type: none"> <li>Auto Tuning</li> <li>Troubleshooting</li> <li>Status Monitor</li> <li>Motor and Encoder</li> <li>Test Run</li> <li>Damping Control</li> <li>Initialize</li> <li>Properties</li> <li>Print</li> <li>Online</li> <li>Offline</li> <li>Direct Connection (USB) ▶</li> </ul>	<ul style="list-style-type: none"> <li>Auto Tuning</li> <li>Motor Setup</li> <li>Troubleshooting</li> <li>Status Monitor</li> <li>Test Run</li> <li>Damping Control</li> <li>Initialize</li> <li>Properties</li> <li>Print</li> <li>Online</li> <li>Offline</li> <li>Direct Connection (USB) ▶</li> </ul>
Registered independently in the project	<ul style="list-style-type: none"> <li>Delete</li> <li>Rename</li> <li>Change Device</li> <li>Setup and Tuning</li> <li>Troubleshooting</li> <li>Status Monitor</li> <li>Motor and Encoder</li> <li>Test Run</li> <li>Damping Control</li> <li>Initialize</li> <li>Properties</li> <li>Print</li> <li>Online</li> <li>Offline</li> <li>Communications Setup</li> </ul>	<ul style="list-style-type: none"> <li>Delete</li> <li>Rename</li> <li>Change Device</li> <li>Auto Tuning</li> <li>Troubleshooting</li> <li>Status Monitor</li> <li>Motor and Encoder</li> <li>Test Run</li> <li>Damping Control</li> <li>Initialize</li> <li>Properties</li> <li>Print</li> <li>Online</li> <li>Offline</li> <li>Communications Setup</li> </ul>	<ul style="list-style-type: none"> <li>Delete</li> <li>Rename</li> <li>Change Device</li> <li>Auto Tuning</li> <li>Motor Setup</li> <li>Troubleshooting</li> <li>Status Monitor</li> <li>Test Run</li> <li>Damping Control</li> <li>Initialize</li> <li>Properties</li> <li>Print</li> <li>Online</li> <li>Offline</li> <li>Communications Setup</li> </ul>

## Right-click Menu Variation

Item selected in the Multiview Explorer	Right-click menu	Description	Drive type		
			1S Series	G5 Series (Except for linear motor type)	G5 Series (Linear motor type)
Servo Drive	Delete	Deletes the Servo Drive.	Available	Available	Available
	Rename	Changes the name of the Servo Drive.	Available	Available	Available
	Change Device	Changes the device.	Available	Available	Available
	Setup and Tuning	Performs the quick parameter setup, I/O monitoring, and tuning easily.	Available	Not available	Not available
	Auto Tuning	Invokes the auto tuning function.	Not available	Available	Available
	Motor Setup	Sets the parameters related to the linear motor.	Not available	Not available	Available
	Troubleshooting	Invokes the troubleshooting function.	Available	Available	Available
	Status Monitor	Invokes the status monitor function.	Available	Available	Available
	Motor and Encoder	Sets up an absolute encoder. Displays the properties of the Servomotor.	Available	Available	Not available
	Test Run	Starts a test run.	Available	Available	Available
	Damping Control	Invokes the damping control function.	Available	Available	Available
	Initialized	Invokes the initialize function.	Available	Available	Available
	Properties	Displays the properties of the Servo Drive.	Available	Available	Available
	Print	Prints the Drive parameter settings, FFT, and data traces.	Available	Available	Available
	Online/Offline	Goes online with the connected Servo Drive.	Available	Available	Available
	Direct connection (USB)	Directly connects to the Drive through a USB cable. This menu command can be executed when the Drive is registered as an EtherCAT slave in the project.	Available	Available	Available
Communications Setup	Configures connection type and settings. This menu command can be executed when the Drive is independently registered in the project.	Available	Available	Available	
Parameters	Edit	Edits the parameters.	Available	Available	Available
FFT	Edit	Invokes the FFT function.	Available	Available	Available

Item selected in the Multiview Explorer	Right-click menu	Description	Drive type		
			1S Series	G5 Series (Except for linear motor type)	G5 Series (Linear motor type)
Data Trace Settings	Add - Data Trace	Adds a data trace.	Available	Available	Available
	Edit	Edits a data trace.			
	Cut	Cuts a data trace.			
	Copy	Copies a data trace.			
	Delete	Deletes a data trace.			

### 2-4-3 Toolbar

Refer to the *Sysmac Studio Version 1 Operation Manual* (Cat. No. W504) for details.



# 2-5 Project Data

This section describes project data related to Drives.

## 2-5-1 Project Management

Sysmac Studio manages configuration information of the devices such as Controllers, Drives, and Vision Sensors on a project basis.

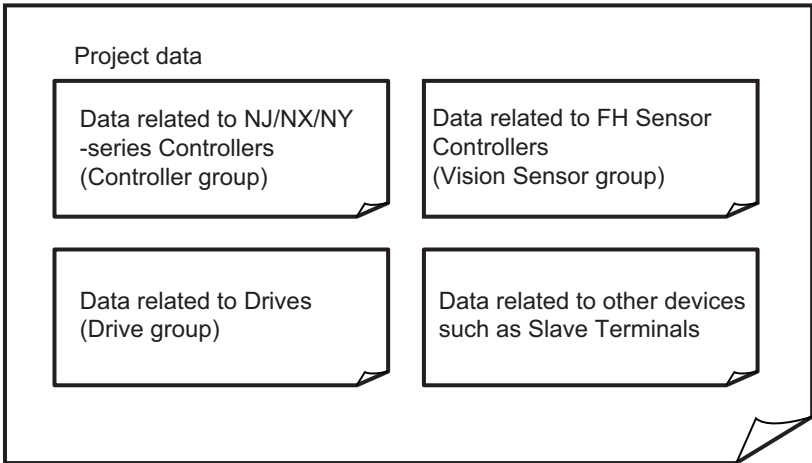

## 2-5-2 Project Data

Each Drive can be registered to the following two kinds of groups in project data.

- Drive group
- Controller group

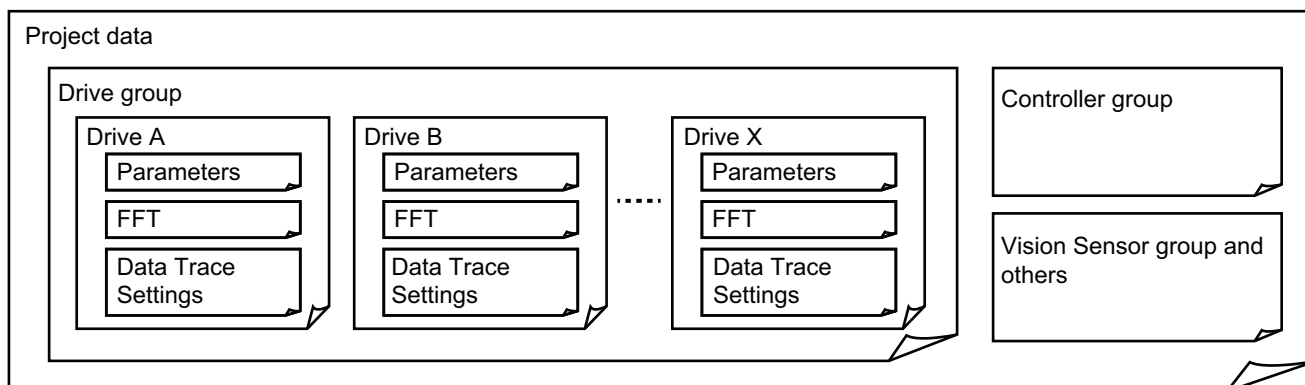

As project data, these groups' data is collectively managed with other groups' data.

Project data is saved in a specific area of the computer.

When you need a data file, export the project file. Refer to the *Sysmac Studio Version 1 Operation Manual* (Cat. No. W504) for details.

### Drive Group

Up to 128 Drives can be registered in a single project file.

The following data of all Drives is managed as a Drive group in the Sysmac Studio project data.

- Parameters
- Trace settings and the latest data trace results
- FFT settings and the latest FFT results

### Controller Group

Up to 512 Drives can be registered as EtherCAT slaves per EtherCAT network in a single project file.

The following data of each Drive is managed as an EtherCAT slave for the Controller group in the Sysmac Studio project data.

- Parameters
- Trace settings and the latest data trace results
- FFT settings and the latest FFT results

## 2-5-3 Import and Export

For data exchange with external devices, each Drive data file and project file can be exported and imported in a specific or general-purpose format.

### ● Exportable Files

Sysmac Studio can export the following files.

File type	Extension	Contents	Operation procedure
Drive parameter file	*.drvvp	Parameter data of each Drive in a specific format for Sysmac Studio drive functions	Display the Parameters tab page and click the <b>Export</b> button. Select <i>Drive Parameters (*.drvvp)</i> in the file type field.
Data trace file	*.csv	Trace settings, latest data trace results, and Drive parameter data at the time of measurement	Display the Data Trace tab page and click the <b>Export</b> button in the Toolbar.
FFT file	*.csv *.drvfft*1	FFT settings, FFT measurement results, and drive parameter data at the time of measurement	Display the FFT tab page and click the <b>Export</b> button in the Toolbar.
Project file	*.smc2, *.csm2, *.smc, *.csm	Same contents as the projects saved by Sysmac Studio	Select <b>Export</b> from the <b>File</b> menu.

\*1. Drive FFT (\*.drvfft) format is only supported for 1S-series Servo Drives.

### ● Importable Files

Sysmac Studio can import the following files.

File type	Extension	Contents	Operation procedure
Drive parameter file	*.drvvp	Parameter data of each Drive in a specific format for Sysmac Studio drive functions	Display the Parameters tab page and click the <b>Import</b> button. Select <i>Drive Parameters (*.drvvp)</i> in the file type field.
	.csv	Parameter data of each Drive exported from CX-Drive	Display the Parameters tab page and click the <b>Import</b> button. Select <i>CX-Drive file (*.csv)</i> in the file type field.
Data trace file	*.csv	Trace settings and trace operation results	Display the Data Trace tab page and click the <b>Import</b> button in the Toolbar.
FFT file*1	*.drvfft	FFT settings, FFT measurement results, and drive parameter data at the time of measurement	Display Advanced Tuning Step 2 Frequency Response Simulation tab page and click the <b>Import</b> button.
Project file*2	*.smc2, *.csm2, *.smc, *.csm	Same contents as the projects saved by Sysmac Studio	Select <b>Import</b> from the <b>File</b> menu.

\*1. Drive FFT (\*.drvfft) format is only supported for 1S-series Servo Drives.

\*2. When importing project file created with a higher Sysmac Studio version, the unsupported features will be reported via Output window.

## 2-6 Functions, Use Cases, and Operation Procedures

This section describes operation procedures and reference sections in this manual for each function and use case.

Description is provided separately for 1S Series and G5 Series.

### 2-6-1 1S Series

Functional category	Use case	Operation procedure	Reference
Parameter editing, transfer, and comparison	Set only motor rotation direction and function assignment to external I/O signals for startup.	Right-click the Drive and select <b>Setup and Tuning</b> from the menu. Select <b>Quick Parameter Setup and I/O Monitor</b> .	3-8-2 <i>Quick Parameter Setup and I/O Monitor</i> on page 3-37
	Transfer motor rotation direction and function assignment to external I/O signals to a Drive.		
	Set not only the basic parameters, but also other parameters.	Double-click <b>Parameters</b> in the Multiview Explorer.	3-1 <i>Displaying and Editing Parameters</i> on page 3-2
	Transfer parameters to a Drive. Compare parameters between Sysmac Studio and Drive.		
Absolute encoder	Set up an absolute encoder including the usage setting.	Right-click the Drive and select <b>Setup and Tuning</b> from the menu. Select <b>Quick Parameter Setup and I/O Monitor</b> .	3-8-2 <i>Quick Parameter Setup and I/O Monitor</i> on page 3-37
	Set up an absolute encoder again because an encoder cable was disconnected and an alarm was activated while using the absolute encoder.	Right-click the Drive and select <b>Motor and Encoder</b> . Then, select <b>Encoder Properties</b> .	3-7-2 <i>Encoder Properties</i> on page 3-35
	Just reset an error related to an absolute encoder.		
Test run	Perform a test run while setting basic parameters.	Right-click the Drive and select <b>Setup and Tuning</b> from the menu. Select <b>Quick Parameter Setup and I/O Monitor</b> .	3-8-2 <i>Quick Parameter Setup and I/O Monitor</i> on page 3-37
	Check whether the motor can run after startup.	Right-click the Drive and select <b>Test Run</b> from the menu.	3-8-3 <i>Test Run and Function Status</i> on page 3-45
	Check the motor rotation direction after startup.		
	Perform jogging after startup.		

Functional category	Use case	Operation procedure		Reference
Tuning	Automatically adjust the gains easily by repeating motor operations.	Right-click the Drive and select <b>Setup and Tuning</b> from the menu.	Select <b>Easy Tuning</b> .	3-8-4 <i>Easy Tuning (Single Drive)</i> on page 3-48
	Check auto tuning results.		Select <b>Advanced Tuning</b> .	
	Adjust damping control.		Select <b>Manual Tuning</b> .	4-1 <i>Manual Tuning</i> on page 4-2
	Make adjustments by the minimum motor operation through a simulation. (Advanced tuning)			
Adjust the gains at the same time by setting the machine rigidity parameter. (Manual tuning)				
Data tracing	Start a data trace and display the waveform of trace data stored in the Drive. (Especially after advanced tuning or manual tuning or after a transfer of changed parameters)	Right-click <b>Data Trace Settings</b> in the Multiview Explorer and select <b>Add - Data Trace</b> from the menu. Then, double-click the data trace.		3-6 <i>Data Tracing</i> on page 3-24
FFT (Fast Fourier Transform)	Analyze the waveforms of machine characteristics for velocity frequency because machine resonance occurs in a specific place.	Double-click <b>FFT</b> in the Multiview Explorer.		4-2-1 <i>FFT</i> on page 4-19
Damping control	Suppress vibration because workpieces are vibrated when the motor is running.  Set the damping control based on the vibration frequency detected by Sysmac Studio.	Right-click the Drive and select <b>Damping Control</b> from the menu.		4-2-2 <i>Damping Control</i> on page 4-23
Status monitor	Check online status parameters for the Drive.	Right-click the Drive and select <b>Status Monitor</b> from the menu.		3-4 <i>Status Monitor</i> on page 3-22
Troubleshooting	Check the current alarms detected for the Drive connected online.	Right-click the Drive and select <b>Troubleshooting</b> from the menu.		3-5 <i>Troubleshooting</i> on page 3-23
Drive initialization	Return all parameters of the Drive connected online to the factory settings.	Right-click the Drive and select <b>Initialize</b> from the menu.		5-1 <i>Initialization of the Drive</i> on page 5-2
Drive properties	Check the model and version of the Drive connected online.	Right-click the Drive and select <b>Properties</b> from the menu.		5-2 <i>Drive Properties</i> on page 5-3
Motor properties	Check the model and version of the motor connected online.	Right-click the Drive and select <b>Motor and Encoder</b> from the menu, and then select <b>Motor Properties</b> .		3-7-1 <i>Motor Properties</i> on page 3-34

## 2-6-2 G5 Series

Functional category	Use case	Operation procedure	Reference
Parameter editing and transfer	Set parameters.	Double-click <b>Parameters</b> in the Multiview Explorer.	3-1 <i>Displaying and Editing Parameters</i> on page 3-2
	Transfer parameters to a Drive.		
	Compare parameters between Tool and Drive.		
Absolute encoder settings	Set up an absolute encoder when using it.	Right-click the Drive and select <b>Motor and Encoder</b> . Then, select <b>Encoder Properties</b> .	3-7-2 <i>Encoder Properties</i> on page 3-35
	Set up an absolute encoder again because an encoder cable was disconnected and an alarm was activated while using the absolute encoder.		
	Just reset an error related to an absolute encoder.		
Test run	Check whether the motor can run.	Right-click the Drive and select <b>Test Run</b> from the menu.	3-3 <i>Test Run</i> on page 3-18
	Check the motor rotation direction.		
	Perform jogging.		
Data tracing	Start a data trace and display the waveform of trace data stored in the Drive.	Right-click <b>Data Trace Settings</b> in the Multiview Explorer and select <b>Add - Data Trace</b> from the menu. Then, double-click the data trace.	3-6 <i>Data Tracing</i> on page 3-24
Tuning	Perform auto tuning easily.	Right-click the Drive and select <b>Auto Tuning</b> from the menu.	3-2-2 <i>Auto Tuning for G5 Series</i> on page 3-12
FFT (Fast Fourier Transform) analysis	Analyze the waveforms of machine characteristics for velocity frequency because machine resonance occurs in a specific place.	Double-click <b>FFT</b> in the Multiview Explorer.	4-2-1 <i>FFT</i> on page 4-19
Damping control	Suppress vibration because workpieces are vibrated when the motor is running.	Right-click the Drive and select <b>Damping Control</b> from the menu.	4-2-2 <i>Damping Control</i> on page 4-23
Status monitor	Check online status parameters for the Drive.	Right-click the Drive and select <b>Status Monitor</b> from the menu.	3-4 <i>Status Monitor</i> on page 3-22
Troubleshooting	Check the current alarms detected for the Drive connected online.	Right-click the Drive and select <b>Troubleshooting</b> from the menu.	3-5 <i>Troubleshooting</i> on page 3-23
Linear motor settings	Use a G5-series Linear Motor.	Right-click the Drive and select <b>Motor Setup</b> from the menu.	4-3 <i>Motor Settings (only for Linear Motor Type of G5 Series)</i> on page 4-27
Drive initialization	Return all parameters of the Drive connected online to the factory settings.	Right-click the Drive and select <b>Initialize</b> from the menu.	5-1 <i>Initialization of the Drive</i> on page 5-2
Drive properties	Check the model and version of the Drive connected online.	Right-click the Drive and select <b>Properties</b> from the menu.	5-2 <i>Drive Properties</i> on page 5-3
Motor properties	Check the model and version of the motor connected online.	Right-click the Drive and select <b>Motor and Encoder</b> from the menu, and then select <b>Motor Properties</b> .	3-7-1 <i>Motor Properties</i> on page 3-34

### 2-6-3 Function and Operation Procedures for Each Drive

The following table gives the supported functions and their operation procedures for each Drive.

Drive	Operation procedure (Item name and menu name)		
	1S Series	G5 Series (Except for linear motor type)	G5 Series (Linear motor type)
Parameter editing	<b>Setup and Tuning or Parameters</b>	<b>Parameters</b>	
Parameter transfer and comparison	<b>Parameters</b> (Some parameters can be transferred to a Drive from the Setup and Tuning wizards.)	<b>Parameters</b>	
Absolute encoder settings	<b>Setup and Tuning or Motor and Encoder</b>	<b>Motor and Encoder</b>	
Test run	<b>Setup and Tuning or Test Run</b>	<b>Test Run</b>	
Tuning	<b>Setup and Tuning - Easy Tuning, Advanced Tuning, or Manual Tuning</b>	<b>Auto Tuning</b>	
Data tracing	<b>Data Trace Settings</b>		
Troubleshooting	<b>Troubleshooting</b>		
Status monitoring	<b>Status Monitor</b>		
FFT (Fast Fourier Transform) analysis	<b>FFT</b>		
Damping control	<b>Damping Control</b>		
Linear motor settings	None	None	<b>Motor Setup</b>
Drive initialization	<b>Initialize</b>		
Drive properties	<b>Properties</b>		

## 2-7 Online Connection Procedure

This section describes how to go online with a Drive.

You can use the following four connection methods to connect Sysmac Studio online with a Drive.

- Direct connection via USB
- EtherCAT connection via an NJ/NX/NY-series CPU Unit
- EtherCAT connection via a Programmable Multi-Axis Controller
- EtherCAT connection via CJ1W-NC□8□ Position Controller

You can perform the online connection after opening a project file or from the start page of Sysmac Studio.

The following table shows the availability of the connection methods in each case.

Timing	Connection method			
	Direct connection via USB	EtherCAT connection via an NJ/NX/NY-series CPU Unit	EtherCAT connection via a Programmable Multi-Axis Controller	EtherCAT connection via CJ1W-NC□8□ Position Controller
After opening a project file	Possible	Possible	Possible	Possible
From the start page of Sysmac Studio	Possible	Not possible	Possible	Possible



## Going Online after Opening a Project File

### ● Direct Connection via USB

There is no need to make the communications settings.

- 1 Select a Drive while editing a project.
- 2 For a Drive that is independently registered in the project, right-click the Drive and select **Online** from the menu.

For a Drive that is registered as an EtherCAT slave in the project, right-click the Drive and select **Direct Connection (USB) - Online** from the menu.



### Precautions for Correct Use

Make sure that Sysmac Studio is offline when the USB cable is plugged in or out from the Drive.

### ● EtherCAT Connection via an NJ/NX/NY-series CPU Unit

- 1 Register the NJ/NX/NY-series Controller as a device in the project.
- 2 Register the Drive in the EtherCAT network of the Controller.

Refer to the *Sysmac Studio Version 1 Operation Manual* (Cat. No. W504) for details.

### ● EtherCAT Connection via a Programmable Multi-Axis Controller

- 1 Select a Drive while editing a project.
- 2 Right-click the Drive and select **Communications Setup** from the menu.
- 3 Set Connection type to **Remote connection via Programmable Multi-Axis Controller (Ether-CAT)**.
- 4 Configure **Connection settings** according to the Controller and Drive to go online with.
- 5 Press **OK**.
- 6 Right-click the Drive and select **Online** from the menu.

### ● EtherCAT connection via CJ1W-NC□8□ Position Controller

- 1 Select a Drive while editing a project.
- 2 Right-click the Drive and select **Communications Setup** from the menu.
- 3 Set Connection type to **Remote connection via CJ1W-NC□8□ Position Controller (Ether-CAT)**.
- 4 Configure **Connection settings** according to the Controller and Drive to go online with.
- 5 Press **OK**.
- 6 Right-click the Drive and select **Online** from the menu.

## Going Online from the Start Page of Sysmac Studio

---

- **Direct Connection via USB**

- 1** Click the **Connect to Device** button without opening a project on the start page of Sysmac Studio.
- 2** Select **Drive** in the **Device** area and click the **Connect** button.  
Sysmac Studio is automatically connected to the Drive and a new project is automatically created for the detected Drive.



### Additional Information

---

You can also perform the direct connection via USB from the EtherCAT configuration tab page.

---

- **EtherCAT Connection via a Programmable Multi-Axis Controller**

- 1** Click the **Connect to Device** button without opening a project on the start page of Sysmac Studio.
- 2** Select **Drive** in the **Device** area.
- 3** Select **Remote connection via Programmable Multi-Axis Controller (EtherCAT)** in the **Connection type** area.
- 4** Configure the **Connection settings** according to the Controller and Drive to go online with.
- 5** Click the **Connect** button.  
Sysmac Studio is automatically connected to the Drive(s) and a new project is automatically created for the detected Drive(s).

- **EtherCAT connection via CJ1W-NC□8□ Position Controller**

- 1** Click the **Connect to Device** button without opening a project on the start page of Sysmac Studio.
- 2** Select **Drive** in the **Device** area.
- 3** Select **Remote connection via CJ1W-NC□8□ Position Controller (EtherCAT)** in the **Connection type** area.
- 4** Configure the **Connection settings** according to the Controller and Drive to go online with.
- 5** Click the **Connect** button.  
Sysmac Studio is automatically connected to the Drive(s) and a new project is automatically created for the detected Drive(s).

- **EtherCAT Connection via an NJ/NX/NY-series CPU Unit**

Connection is not possible.

# 3

## Basic Servo Drive Operations

This section describes basic operations of Servo Drives such as parameter editing, auto tuning, and troubleshooting.

---

<b>3-1</b>	<b>Displaying and Editing Parameters</b>	<b>3-2</b>
3-1-1	Displaying and Editing Drive Parameters	3-2
3-1-2	Displaying and Editing Multi-drive Parameters (Drive Setting Table)	3-9
<b>3-2</b>	<b>Auto Tuning</b>	<b>3-11</b>
3-2-1	Auto Tuning for 1S Series	3-11
3-2-2	Auto Tuning for G5 Series	3-12
<b>3-3</b>	<b>Test Run</b>	<b>3-18</b>
<b>3-4</b>	<b>Status Monitor</b>	<b>3-22</b>
<b>3-5</b>	<b>Troubleshooting</b>	<b>3-23</b>
<b>3-6</b>	<b>Data Tracing</b>	<b>3-24</b>
<b>3-7</b>	<b>Motors and Encoders</b>	<b>3-34</b>
3-7-1	Motor Properties	3-34
3-7-2	Encoder Properties	3-35
<b>3-8</b>	<b>Setup and Tuning Wizard</b>	<b>3-36</b>
3-8-1	Overview	3-36
3-8-2	Quick Parameter Setup and I/O Monitor	3-37
3-8-3	Test Run and Function Status	3-45
3-8-4	Easy Tuning (Single Drive)	3-48
3-8-5	Easy Tuning (Multiple Drives)	3-59

## 3-1 Displaying and Editing Parameters

This section describes how to display and edit drive parameters.

### 3-1-1 Displaying and Editing Drive Parameters

#### ● Displaying Parameters

Right-click **Parameters** in the Multiview Explorer and select **Edit** from the menu. The following parameter editor is displayed.

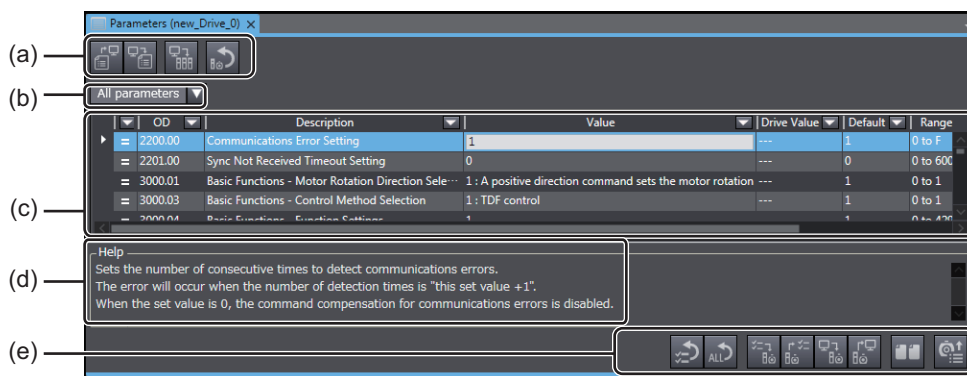

Parts of the editor

Column	Description	
(a) Upper toolbar	Buttons to export/import parameter values to/from an individual drive parameter file.	
(b) Parameter category	Select the parameters to display/edit by specifying a category, User Selection category, or a control mode. <ul style="list-style-type: none"> <li>The default selection is <i>All parameters</i>.</li> <li>You can register only the necessary parameters to the User Selection category.</li> </ul>	
(c) Parameter list	OD	Index numbers ((Index).(Subindex)) of parameters* <sup>1</sup> in the Drive.
	Description	Parameter names (or object names).
	Value	Values of the parameters being edited in Sysmac Studio.
	Drive Value	Values of the parameters stored in the Drive connected online.
	Default	Default values of the parameters stored in the Drive connected online.
	Range	Valid ranges for the parameter values.
	Units	Units of the parameter values.
(d) Help	Information on the currently displayed parameter. Refer to <i>Attribute Symbols</i> on page 3-3 described later for details.	
(e) Lower toolbar	Buttons to transfer all or selected parameters to/from the Drive or compare all parameters with the ones in the Drive.	

\*1. Indicates object dictionaries (abbreviated as "OD") for the EtherCAT slave types of Drives. "Object dictionary" refers to data specifications of the parameters and control information of EtherCAT slaves.

## ● Attribute Symbols

Refer to operational manual of each drive.

## ● Selecting Parameters to Display

Select the drive parameters to display according to your purpose.

### 1 Selecting the Category to Display

Select **All Categories** and then a category from the drop-down list displayed above the parameter list.

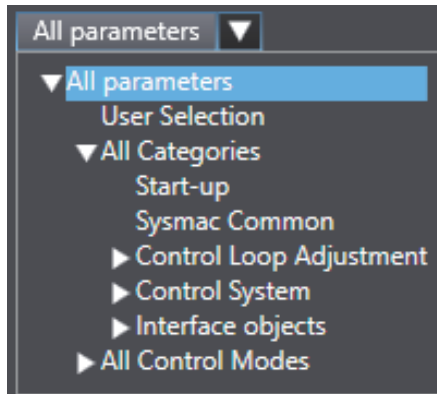

The parameters can be selected and displayed according to the categories predefined for each Drive series.



### Additional Information

#### Category list for 1S Series

Category name	Description
▼ All parameters	All parameters
User Selection	Parameters registered in the User Selection category
▼ All Categories	Parameters in all categories
Start-up	Parameters related to basic setup
Sysmac Common	Common parameters to Sysmac
▼ Control Loop Adjustment	Parameters related to the Servo Drive's gain adjustment
TDF Position Control	Gains under 2-degree-of-freedom mode Position Control
TDF Velocity Control	Gains under 2-degree-of-freedom mode Velocity Control
ODF Position Control	Gains under 1-degree-of-freedom mode Position Control
ODF Velocity Control	Gains under 1-degree-of-freedom mode Velocity Control
Torque Control	Gains under Torque Control, regardless of the control method
▼ Control System	Control-related parameters
Control Mode Area	Parameters in all control modes
Control Method Area	Parameters related to control methods (1-degree-of-freedom and 2-degree-of-freedom)
Control Loop Area	Parameters related to the Drive's gains
Torque Output Area	Parameters related to torque compensation and filters
Homing Area	Parameters related to homing
Applied Functions Area	Parameters related to other applied functions
▼ Interface objects	Parameters related to the Drive's interfaces
Warnings or Errors Area	Parameters related to warnings and errors
Monitoring Area	Parameters related to monitoring system for the Servo Drive
Display Area	Parameters related to the 7-segment LED indicator
Power Device Area	Parameters related to the power device (main circuit power supply and regeneration)
Encoder Area	Parameters related to the encoder

Category name	Description
Analog Input and Output Area	Parameters for the I/O interfaces
▼All Control Modes	Parameters in all control modes
Cyclic synchronous position mode	Parameters related to cyclic synchronous position mode
Cyclic synchronous velocity mode	Parameters related to cyclic synchronous velocity mode
Cyclic synchronous torque mode	Parameters related to cyclic synchronous torque mode
Profile position mode	Parameters related to profile position mode
Profile velocity mode	Parameters related to profile velocity mode
Homing mode	Parameters related to homing mode of the Servo Drive

### Category list for G5 Series

Category name	Description
▼All parameters	All parameters
User Selection	Parameters registered in the User Selection category
▼All Categories	Parameters in all categories
CiA 402 Drive Profile	Parameters related to CiA402
Pn0xx: Basic Parameters	Basic parameters
Pn1xx: Gain Parameters	Gain-related parameters.
Pn2xx: Vibration Suppression Parameters	Parameters related to the filters that suppress vibration
Pn3xx: Analog Control Parameters	Analog-related parameters
Pn4xx: I/F Monitor Setting Parameters	I/O-related parameters
Pn5xx: Extended Parameters	Extended parameters
Pn6xx: Special Setting 1 Parameters	Special-purpose parameters other than above
Pn7xx: Special Setting 2 Parameters	Special-purpose parameters other than above
Pn8xx: Special Setting 3 Parameters	Special-purpose parameters other than above
All Control Modes	Parameters related to all control modes

- 2** Using the User Selection List to Select and Display only the Necessary Parameters.  
Use the User Selection list to select and display the frequently used parameters only.

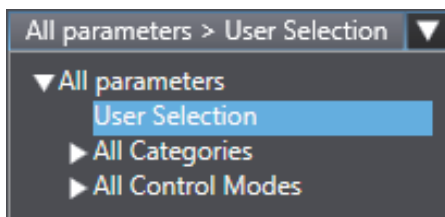

- (1) Adding a parameter to the User Selection list.

Right-click the parameter in the parameter editor and select **Add to 'User Selection'** from the menu. If there are multiple lists, select the list to which the selected parameter is added.

Use the **Shift** key or **Ctrl** key to select and add more than one parameter at the same time.

- (2) Deleting a parameter from the User Selection list.

After selecting the **User Selection** from the drop-down list, right-click the parameter and select **Remove from 'User Selection'** from the menu. If there are multiple lists, select the list from which the selected parameter is removed.

Use the **Shift** key or **Ctrl** key to select and delete more than one parameter at the same time.

### 3 Using the Filtering Function to Select and Display only the Necessary Parameters.

#### (1) Filtering by specifying a search string

The parameters whose name contains the specified text string are displayed. Click the black down-pointing triangle (▼) symbol displayed in the header of the column and enter the search string in the entry field displayed on the upper part.

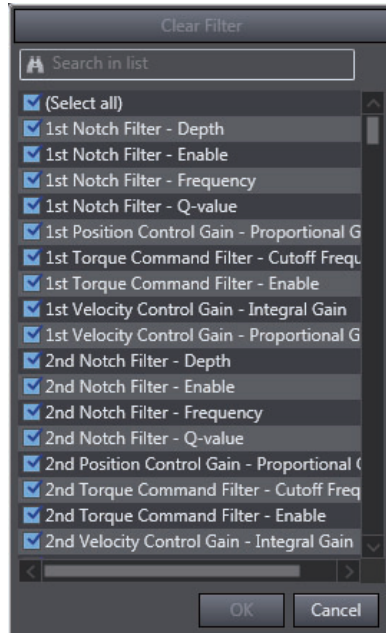

#### (2) Filtering by directly selecting the necessary parameters from the list

The parameters selected from the list are displayed. Click the black down-pointing triangle (▼) symbol displayed in the header of the column and select the necessary parameters from the list.

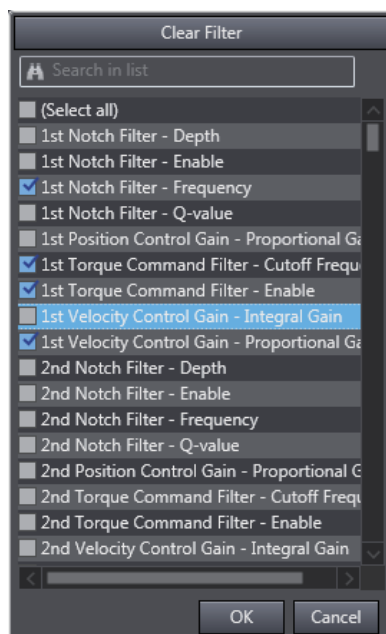

## ● Displaying the Right-click Menu

The following table gives a list of menu commands displayed when a parameter is right-clicked and functions of the menu commands.

Menu command	Description
Add to 'User Selection'	Registers the selected parameters to the User Selection category.
Remove from 'User Selection'	Deletes the selected parameters from the User Selection category.
Organize 'User Selection'	User Selection lists can be customized with following operations: creation of new lists, renaming and deletion of existing lists, and exporting/importing lists.
Select All	Selects all the currently displayed parameters.
Reset Selection	Initializes the selected parameters.
Selection to Drive	Downloads the selected parameters from the computer (i.e., Sysmac Studio) to the Drive.
Selection from Drive	Uploads the selected parameters from the Drive to the computer (i.e., Sysmac Studio).
Copy	Copies the selected parameters.
Paste	Pastes the selected parameters.

## ● Editing Parameters



### 1 Entering a Parameter

- Entering a value directly in the parameter editor.  
Click the **Value** column of the parameter and set a value.  
The changed values are indicated in purple. If a value is out of range or invalid, it is indicated in red.
- Copy & Paste  
Copy and paste a parameter value in the parameter editor.

Note Parameters cannot be copied and pasted between an external editor and the parameter editor.

- Export & Import  
You can export/import the parameter list to/from a file.
  - The parameters are exported to a .drvp file.
  - The drive project can be imported only when its drive model and version are the same as those of the exported file.

Execute each function by clicking the following buttons in the upper toolbar.







Button	Name	Description
	Export	Saves all parameter values to a drive parameter (drvp) file.
	Import	Loads all parameter values from a drive parameter (drvp) file.



## 2 Checking the Parameter Status



Check the present value status with the status icons displayed in the leftmost column of the parameter editor.

Status icons

Status icon	Value status
	The present value matches the default value.
	The present value matches the default value, but does not match the value stored in the Drive.
	The present value does not match the default value.
	The present value does not match the default value nor the value stored in the Drive.
	The present value is invalid. (The value is out of range or the data type does not match.)
	The present value is invalid and does not match the value stored in the Drive.
	Read only. The status of the Drive is displayed.







## 3 Returning the Parameters to their Default Values.

Parameters can be reset to their default values. Click one of the following buttons in the lower toolbar to perform a Reset operation:

Button	Name	Description
	Reset Selection	Returns the values of the selected parameters to their default values.
	Reset All	Returns the values of all parameters to their default values.

### ● Transferring Parameters to the Drive (Available Only While Online)

Parameters can be transferred to and from the Drive to refresh the parameter editor or display the comparison results. Execute each function by clicking the following buttons in the lower toolbar.

Button	Name	Description
	Transfer Selection to Drive	Transfers the values of the selected parameters from Sysmac Studio to the connected Drive. Use the <b>Shift</b> key or the <b>Ctrl</b> key to select more than one parameter at the same time.
	Transfer Selection from Drive	Transfers the values of the selected parameters from the connected Drive to Sysmac Studio. Use the <b>Shift</b> key or the <b>Ctrl</b> key to select more than one parameter at the same time.
	Transfer All to Drive	Transfers the values of all parameters from Sysmac Studio to the connected Drive.
	Transfer All from Drive	Transfers the values of all parameters from the connected Drive to Sysmac Studio.
	Compare	Compares the values of all parameters in Sysmac Studio with the values stored in the connected Drive.
	Update Drive Settings with Estimated Values	Updates the Drive settings with the inertia ratio, torque compensation, notch filter values estimated during the motor operation. This operation can be executed only for 1S-series Servo Drives.

### ● Restarting the Drive (Available Only While Online)

The Servo Drive can be restarted from the parameter editor. This operation is available only for the 1S-series Servo Drives using any connection other than EtherCAT via CJ1W-NC□8□ Position Controller.

Click the **Restart** () button in the upper toolbar to restart the drive.



#### Precautions for Safe Use

- When you restart a Servo Drive, the ESM state of the Servo Drive will change in the following order: Operational → Init → Operational.
- By the above state transition, the commands to the Servomotor will be stopped. If the device is running, make sure to stop the operation before executing the restart operation.
- When you use the NJ/NX/NY-series, the Controller will enter the minor fault state due to the ESM state transition. Therefore, connect Sysmac Studio to the Controller and execute troubleshooting to reset the error.

### ● Executing a Config Command for a Drive

The Config command can be executed for Servo Drives. The Servo parameters whose attribute is "C" become valid. The command can be executed only when a G5-series Servo Drive is connected online via EtherCAT.



#### Additional Information

After this command is executed, Error 27.7 Position Data Initialized occurs in the Servo Drive.

## ● Copying the Settings

The parameter settings can be copied to other Drives. You can select more than one Drive as the copy destination and transfer the parameter settings after copy. The settings can be copied only to the same-series Servo Drives.



### Precautions for Correct Use

Confirm that the destination Drives and parameter settings are correct before transferring the setting values.

## 3-1-2 Displaying and Editing Multi-drive Parameters (Drive Setting Table)

### ● Starting Drive Setting Table

For a controller project, right-click **EtherCAT** on the tree in the Multiview Explorer and select **Drive Setting Table**.

For a drive project, right-click **Device Group** on the tree in the Multiview Explorer and select **Drive Setting Table**.

When a list of Drives registered in the relevant project appears, select one Drive and click the **OK** button.

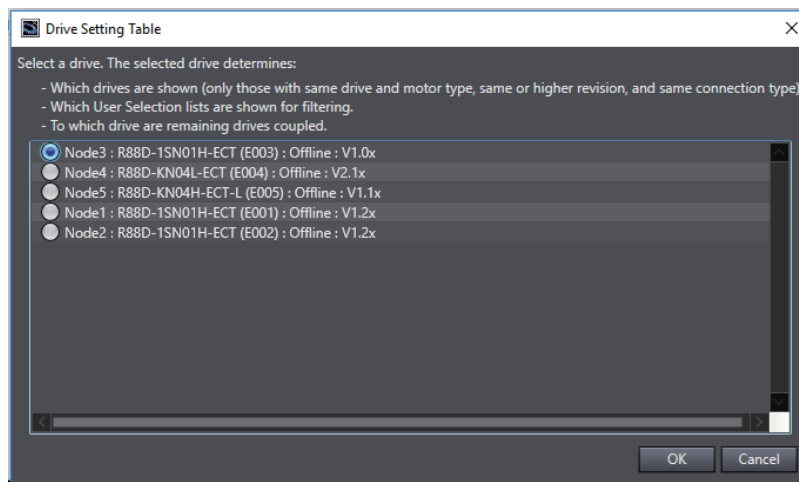

### Additional Information

Drive Setting Table displays Drives with revision in the same series as and compatible with the selected Drive. For a drive project, additionally, Drive Setting Table displays only Drives of the same Connection type as the selected Drive.

In Drive Setting Table, the User Selection category of the selected Drive can be used.

When parameters for the selected Drive are edited, they can be automatically applied to other Drives displayed in Drive Setting Table.

● **Operating Drive Setting Table**

In Drive Setting Table, you can display and edit parameters being edited by Sysmac Studio.

For details on parts of and how to operate Drive Setting Table, refer to *3-1-1 Displaying and Editing Drive Parameters* on page 3-2.

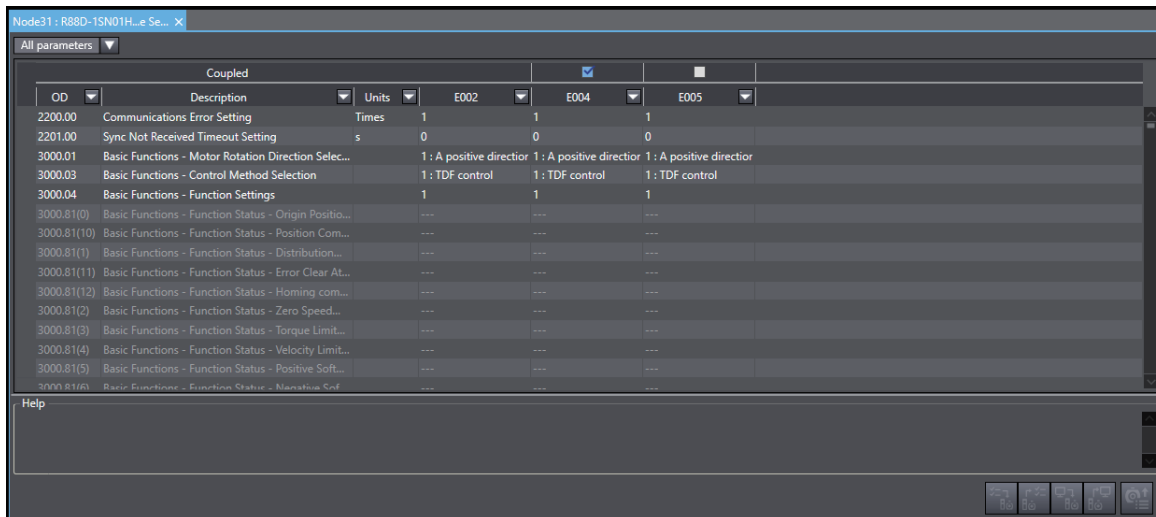

● **Applying Parameters to Other Drives**

You can automatically apply the results of editing performed on parameters of the Drive selected at startup to other Drives. Select the **Coupled** check boxes for the Drives you want to apply the results to.

## 3-2 Auto Tuning

To take full advantage of machine's performance, the motor should run exactly according to the given commands without any time delay. Therefore, you need to adjust the Servo Drive according to the characteristics of the machine.



### Precautions for Safe Use

- The motor operates during the adjustment. Confirm safety at the destination node.
- If abnormal noise or vibration occurs, immediately turn OFF the power supply or the Servo.
- Gain adjustment is automatically performed by the Servo Drive. The motor operates during the adjustment. Follow the following safety precautions.
  - 1) Provide a means to perform an emergency stop (i.e., to turn OFF the power supply). The response may greatly change during the adjustment.
  - 2) Confirm safety around all moving parts. Always confirm that there are no obstacles in the movement range and directions of the motor and that the motor can operate safely. Provide protective measures for unexpected motion.
  - 3) Before you start the adjustment, make sure that the device that is being adjusted is not out of place. Before you start normal operation, make sure to perform homing to reset the position. If home is not reset before the adjustment is performed, the motor may run away, creating a very hazardous condition. Confirm the safety of the system if you use a vertical axis. Make sure that the object that is being adjusted does not fall when the Servo is turned OFF.
  - 4) If vibration or oscillation occurs when auto tuning is performed, manually reduce the gain until the system is stable.
- During auto tuning, the motor operates and the workpiece moves greatly. Provide a means so that you can turn OFF the Servo immediately during auto tuning.

### 3-2-1 Auto Tuning for 1S Series

In the 1S Series, the auto tuning function is provided as part of the Setup and Tuning wizard function. Refer to 3-8-4 *Easy Tuning (Single Drive)* on page 3-48 for details.

## 3-2-2 Auto Tuning for G5 Series

### ● Starting the Tuning Wizard

Right-click the tuning-target Drive and select **Auto Tuning** from the menu.

A wizard is started for tuning the G5-series Drive. Click the **Easy Tuning** button.

### ● Executing the Tuning

Execute the tuning according to the wizard that consists of 6 steps below in consideration of device startup process. When the tuning-related parameters are changed in each step, they are automatically transferred to the Drive.

Step	Name	Description
1	Mechanical System Selection	Select your mechanical system.
2	Auto Tune Parameter Configuration	Set the default rigidity.
3	Behavior Configuration	Set the parameters for tuning behavior.
4	Auto Tune Monitor	Execute the auto tuning and monitor its progress.
5	Check Behavior	Check the tuning effects by data tracing.
6	Finish	Check the parameters changed by tuning.

## Step 1: Mechanical System Selection

Select the closest mechanical configuration to your system. If nothing is applicable, select **Other Machines**.

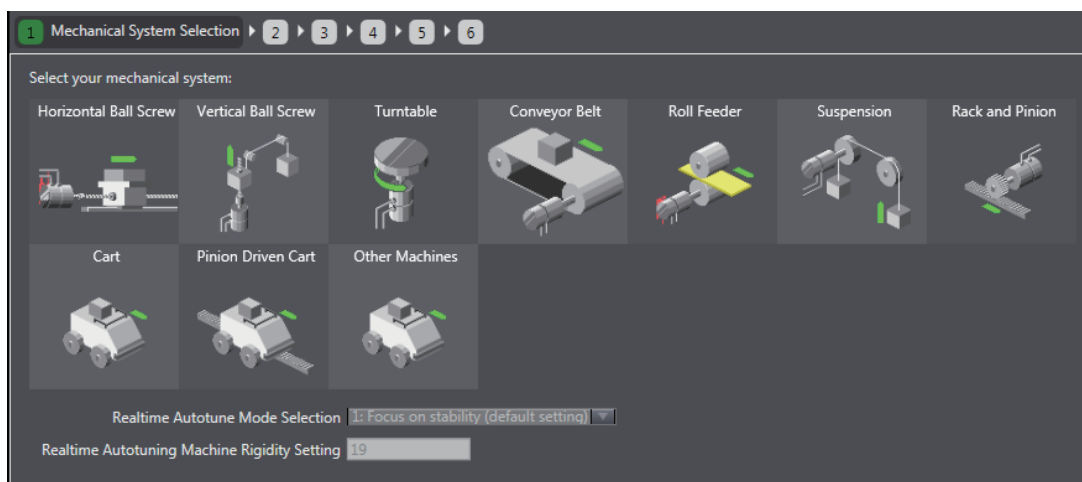

- **Realtime Autotune Mode Selection**  
Select the realtime autotune mode only when the mechanical system is set to **Other Machines**. (When any of the other mechanical systems is selected, it is set automatically.) Select the mode according to your mechanical system.
- **Realtime Autotuning Machine Rigidity Setting**  
The default rigidity value for the selected mechanical system is displayed.

After making the settings, click the **Next** button to go to the next step.

## Step 2: Auto Tune Parameter Configuration

Make the settings to be applied when auto tuning is started.

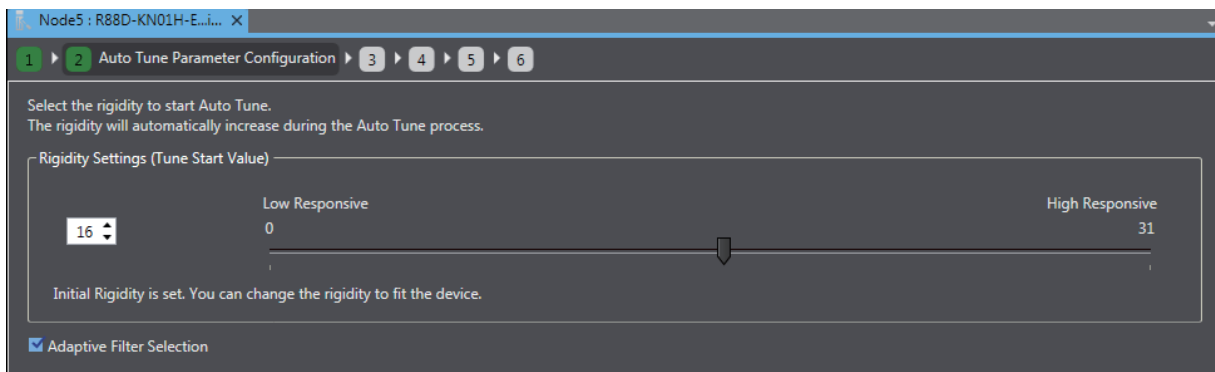

### ● Setting the Default Rigidity

- Based on the machine configuration selected in Step 1, the default value at tuning start is automatically set.
- Normally, you don't have to change it, but you can set the value within the range from 0 to 31 according to the device characteristics.
- The rigidity value is automatically increased during the Auto Tuning process in Step 3.

### ● Setting the Adaptive Notch Filter

- Select whether the adaptive notch filter function is enabled or disabled by the *Adaptive Filter Selection* check box.

**Note** Refer to the *G5-series AC Servomotors and Servo Drives User's Manual (with Built-in EtherCAT® Communications)* (Cat. No. I576) and the *G5-series Linear Motors/Servo Drives User's Manual (with Built-in EtherCAT® Communications)* (Cat. No. I577) for details of the relationship between rigidity value and parameter values and the adaptive notch filters.

After making the settings, click the **Next** button to go to the next step.

## Step 3: Behavior Configuration

Set the criteria for performing and finishing auto tuning.

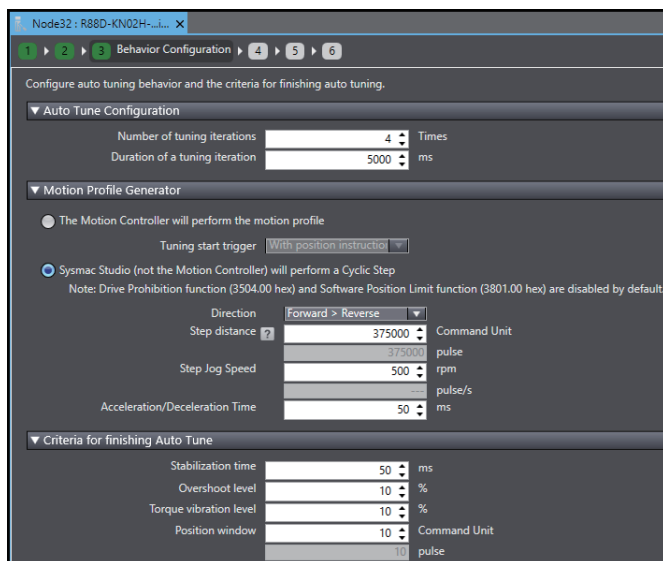

### ● Setting Auto Tuning Conditions

In the **Auto Tune Configuration** area, set the number of tuning iterations and duration of a tuning iteration.

### ● Selecting the Motion Profile Generator

You need to actually run the motor to execute auto tuning. Select whether the Motion Controller or Sysmac Studio sends the operation commands to the motor.

- The Motion Controller will perform the motion profile
  - Select the tuning start trigger from *With position instruction* or *With speed instruction* according to the control mode of the device.
- Sysmac Studio (not the Motion Controller) will perform a Cyclic Step
  - Set the step distance, step jog speed, and acceleration/deceleration time according to the operation status of the device.

### ● Setting the Criteria for Finishing Auto Tuning

As the auto tuning completion criteria, set the stabilization time, overshoot level, torque vibration level, and position window according to the operation status of the device.

After making the settings, click the **Next** button to go to the next step.



## Step 4: Auto Tune Monitor

Start execution of auto tuning.

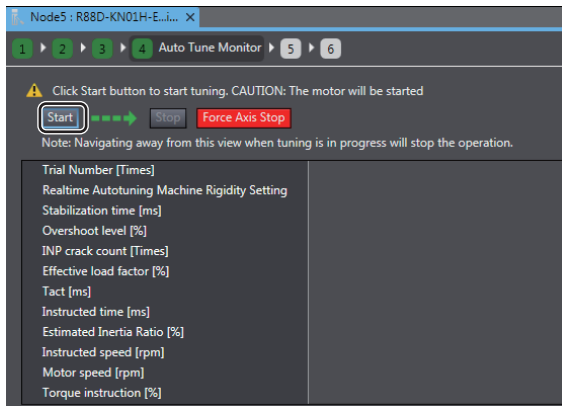

### ● Starting the Tuning

Click the **Start** button to start auto tuning.

When the completion criteria are satisfied or motor vibration is detected during the tuning process, auto tuning will be stopped.

- Message displayed when Auto Tuning is Complete

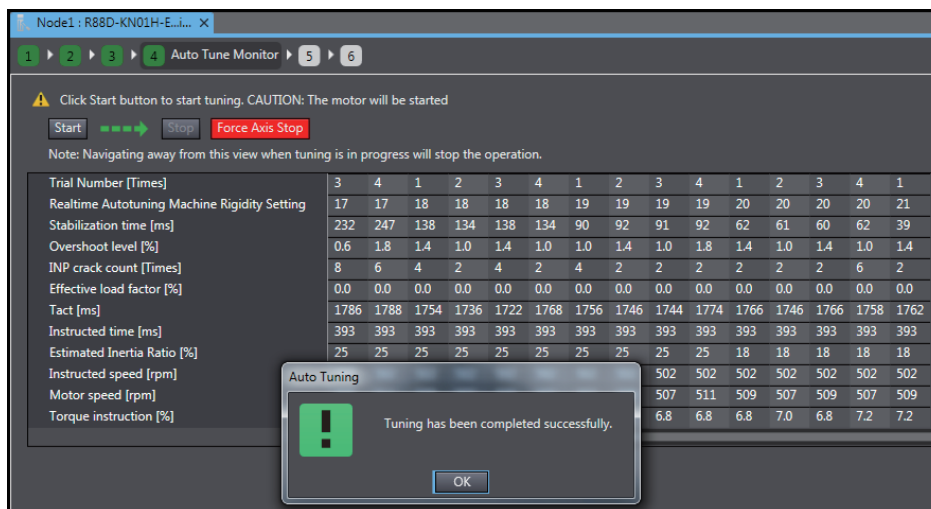

### ● Stopping the Tuning

When you want to stop the tuning before completion, click the **Stop** button. The motor will be stopped and the Drive will enter the Servo OFF state.

### ● Forcibly Stopping the Tuning

Click the **Force Axis Stop** button to forcibly stop the auto tuning. The motor will be stopped and the Drive will enter the Servo OFF state.

After making the settings, click the **Next** button to go to the next step.

## Step 5: Check Behavior

Check the tuning results of the previous step using the data trace function. Refer to 3-6 *Data Tracing* on page 3-24 for details of the data trace function.

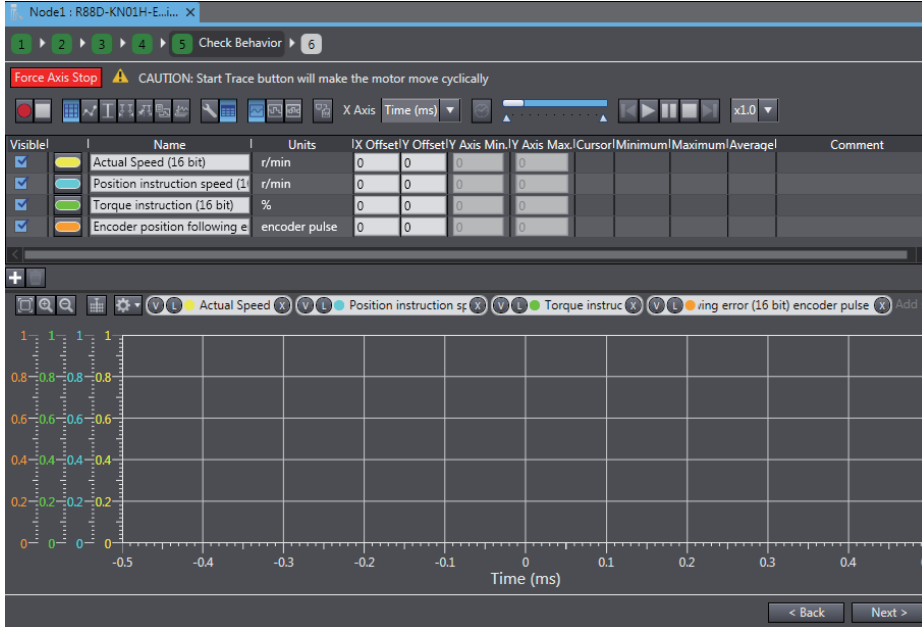

### ● Data Trace Settings

By default the most frequently used parameters (actual speed, position instruction speed, torque instruction, and encoder position following error) are registered to check the motor response. Like the standard data trace function, you can add and delete the trace items as necessary.

### ● Starting Data Tracing

When you click the start button, data tracing will be started. When it is completed, the results will be displayed in the graph area.

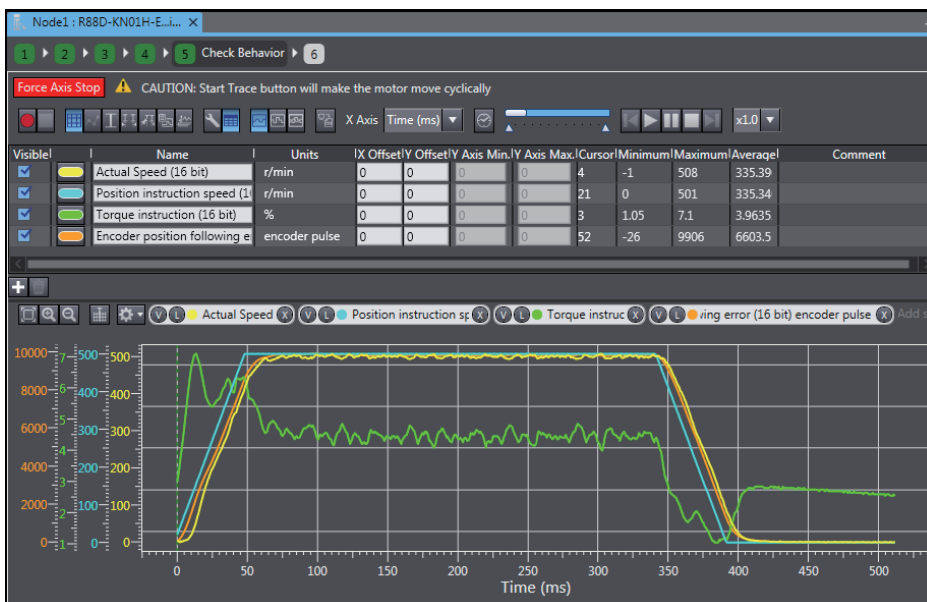

After confirmation, click the **Next** button to go to the next step.

## Step 6: Finish

The auto tuning results are displayed in the form of parameter list. The parameters changed by auto tuning are highlighted in purple.

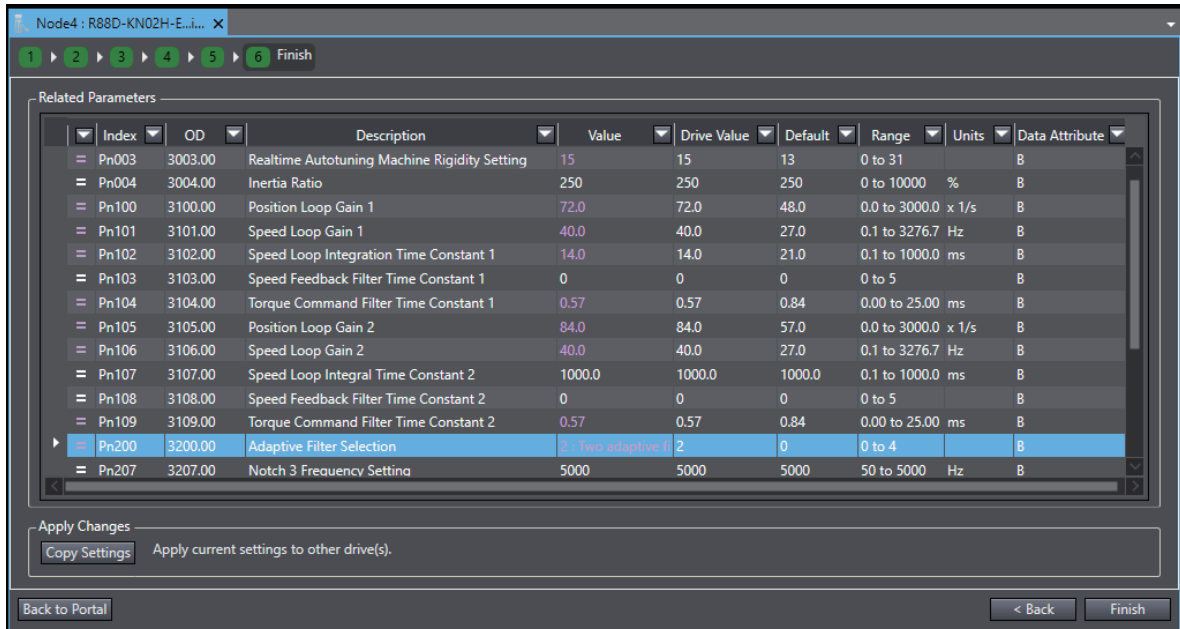

### ● Step 6-1: Copying the Settings

Click the **Copy Settings** button to copy the related parameters to other Drives. Refer to *3-1-1 Displaying and Editing Drive Parameters* on page 3-2 for details.

After confirmation, click the **Finish** button to close the Auto Tuning wizard.

## 3-3 Test Run

---

This section describes how to perform jogging and other test run operations to check motor operations such as its rotation direction.



### Precautions for Safe Use

---

- Confirm the axis number carefully before you perform a test run.
  - A test run operation involves motor operation. Refer to the operation manual before you execute a test run. Be particularly careful of the following points.
    - Confirm safety around all moving parts.
    - When you push the start button, the motor begins actual operation at the specified velocity. Begin the motor operation only when you are absolutely sure there is no danger if you start the motor.
    - Always have an external emergency stop device available.
    - Sometimes you may be unable to stop the motor from your computer. Install an external emergency stop device so that you can stop the motor immediately if needed.
    - Only operate the motor when you can clearly confirm the motor operation so that you can react quickly in the case of any danger that may arise due to operation of the motor.
    - When you perform a test run via an NJ/NX/NY-series, Programmable Multi-Axis Controller or CJ1W-NC□8□ Position Controller, perform the test run operations after establishing EtherCAT communications.
    - A communications error will occur if you attempt to begin operations without EtherCAT communications. Always establish EtherCAT communications first.
  - When operation is performed, such data as a travel distance and velocity calculated from the unit conversion settings for the axes assigned on the project file is displayed. Before performing operation, carefully check safety by using units of drive measurement such as command units.
  - Precautions during Test Run Operation
    - During test run execution, only Sysmac Studio has any control of the operation. Any commands from motion control instructions are ignored.
    - Make sure that you are operating the correct axis.
- 



### Precautions for Correct Use

---

- Before you start a test run, make sure that the operation parameters are set correctly.
  - If you transfer the axis parameters or slave parameters to the slave during a test run from another copy of Sysmac Studio, the test run will end and the axes will stop. This also applies if the parameters are transferred from Sysmac Studio running on a different computer.
-

● **Starting a Test Run**

Right-click the Drive and select **Test Run** from the menu.

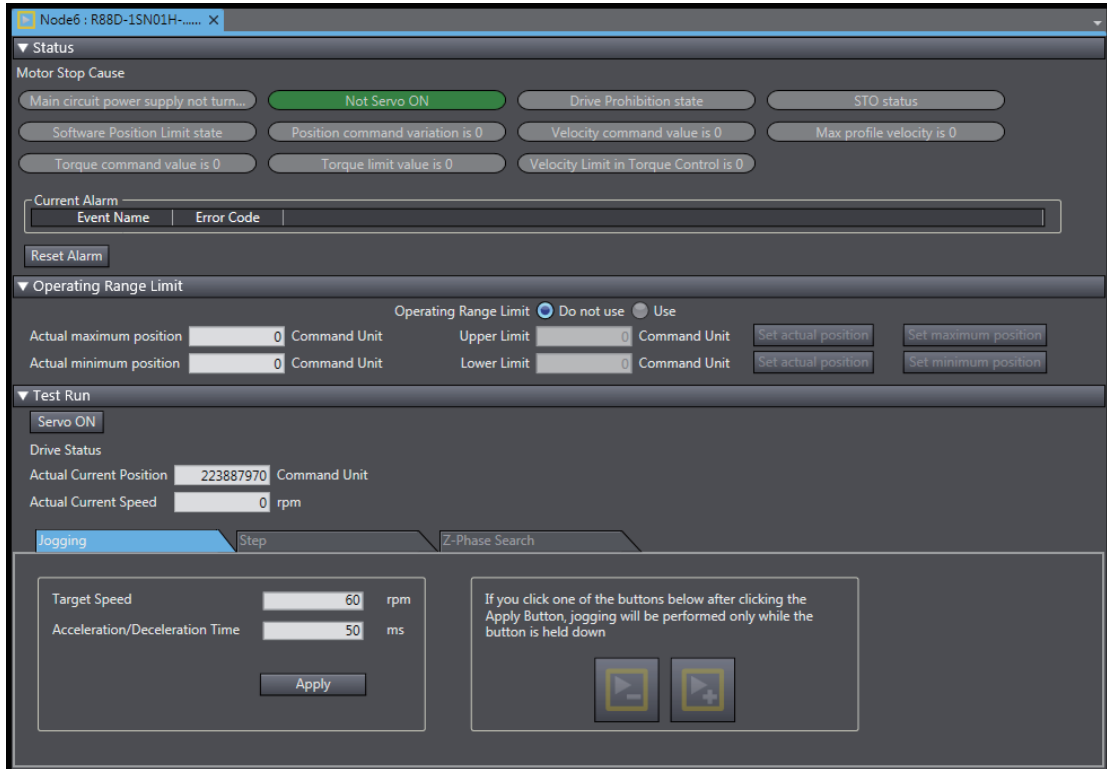

● **Test Run Operation Settings (only for 1S Series)**

To execute the test run operation safely, preset the operating range limits for the motor.

- Enabling/Disabling the Operating Range Limits

Select *Do not use* or *Use* for the **Operating Range Limit** setting.

- Setting the Upper and Lower Limits of the Operating Range

To set the upper limit and lower limit values, click the setting buttons (i.e., **Set actual position**, **Set maximum position**, and **Set minimum position** buttons). You cannot directly enter values in the fields.

- Operating Range Limit Settings

Item	Description
Actual maximum position and Actual minimum position	Actual maximum and minimum positions of the currently running motor are displayed. (Unit: Pulse)
Upper Limit and Lower Limit	The upper and lower limits of the current operating range are displayed. (Unit: Pulse)

- How to Apply the Current Position to Upper or Lower Limit

Click the **Set actual position** button to apply the actual current position displayed in the **Test Run** area (enclosed in the green box) to the upper or lower limit. Then, the value is set for the upper or lower limit as shown below.

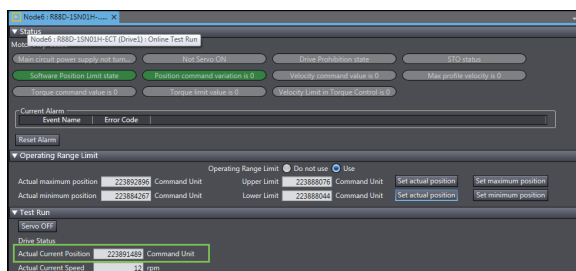

- How to Apply the Maximum or Minimum Position to the Upper or Lower Limit

Click the **Set maximum position** or **Set minimum position** button on the extreme right of the figure to apply the maximum or minimum position during the operation to the upper or lower limit, respectively.

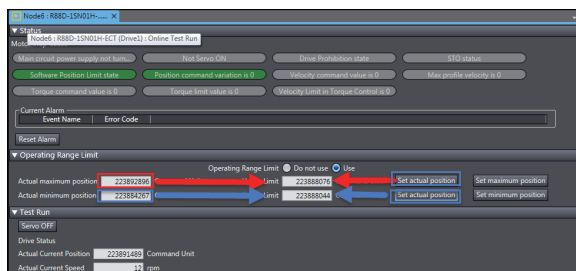

## ● Executing a Test Run

- Servo ON





Click the **Servo ON** button to enter the Servo ON status in order to start a test run.

- Starting the Operation

In the test run, the following operations can be commanded.

Operation	Description
Jogging	Speed-specified commands are executed.
Step	Positioning with trapezoidal acceleration/deceleration is repeated for the specified number of cycles.
Z-Phase Search	The Z-phase search is executed.

Select one of the operation patterns by clicking a tab in the **Test Run** area. Then, set the operation parameters and click the Forward or Reverse button to execute the test run.

Tab	Settings	Operation
<b>Jogging</b>	<ul style="list-style-type: none"> <li>• Target Speed</li> <li>• Acceleration/Deceleration Time</li> </ul>	The motor will run while the Forward (  ) button or Reverse (  ) button is held down.
<b>Step</b>	<ul style="list-style-type: none"> <li>• Target Speed</li> <li>• Acceleration/Deceleration Time</li> <li>• Step Distance</li> <li>• Cycle steps (Forward &gt; Reverse, Reverse &gt; Forward, Forward, or Reverse)</li> <li>• Number of Cycles</li> <li>• Dwell Time</li> </ul>	The step operation will be started by clicking the  button.
<b>Z-Phase Search</b>	<ul style="list-style-type: none"> <li>• Target Speed</li> </ul>	The Z-phase search is started by clicking the  button. The operation is automatically stopped when Z-phase of the encoder is detected.



### Additional Information

If the motor does not run, check the Motor Stop Cause status lamps.

## ● Checking the Operating Status of the Motor

The current position and current motor speed are displayed in the **Drive Status** of the **Test Run** area.

## ● Checking the Motor Status

- Motor Stop Causes

Lamps are provided to show motor stop causes. A green lamp indicates an active cause.

- Current Alarms and How to Reset

The alarms listed here have been activated for the Drive. The alarms can be reset by clicking the **Reset Alarm** button.

## 3-4 Status Monitor

The Status Monitor displays a list of objects for monitoring the Drive. Check the present values of the objects.

### ● Starting the Status Monitor

Right-click the Drive and select **Status Monitor** from the menu.

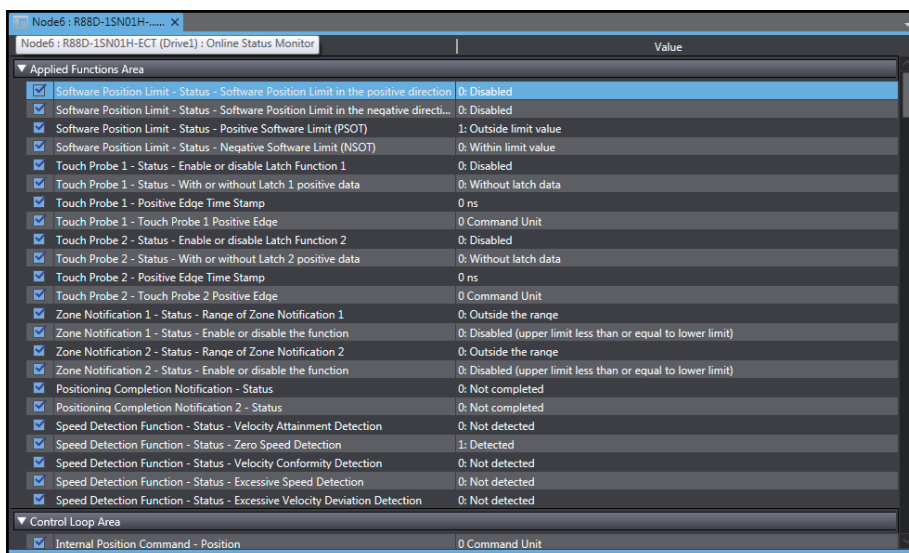

### ● Selecting the Target Objects to Monitor

Select the check boxes for the objects to be monitored. The latest values of the parameters for the selected objects are transferred from the Drive and displayed in the monitor.

### ● Displaying the Present Values of the Objects

The latest values of the parameters in the Drive are displayed. When a value is updated, it is displayed in purple for one second.



## 3-5 Troubleshooting

Use the troubleshooting function to check the current errors related to the Drive and the event log stored in the Drive.

### ● Starting the Troubleshooting

Right-click the Drive and select **Troubleshooting** from the menu. The current error information on the Drive will be displayed.

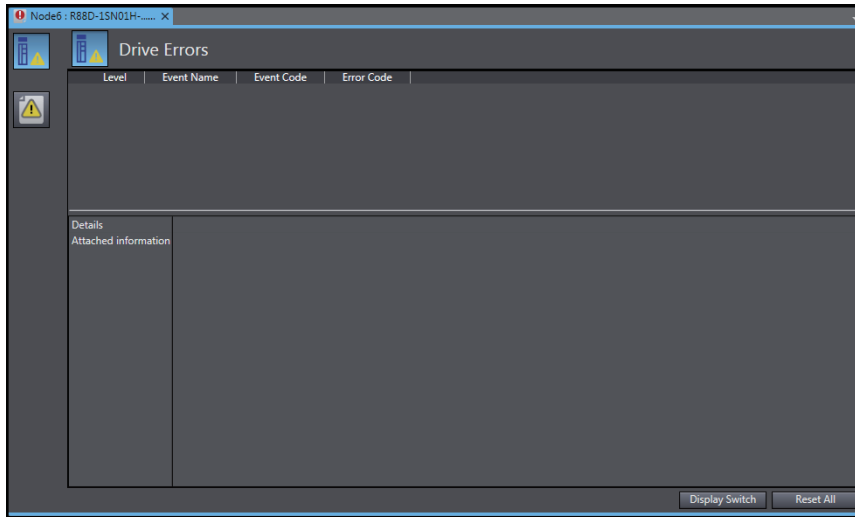

### ● Checking the Drive Errors

Click the **Drive Errors** (  ) button. The current errors related to the Drive are displayed. Check the level, event name, event code, error code, and details of the event code.

- Click the **Display Switch** button to switch the view between *Details/Attached information* and *Action and correction*.
- Click the **Reset All** button to reset the errors.

### ● Checking the Drive Event Log

Click the **Drive Event Log** (  ) button. The event log (i.e., history) of the Drive is displayed. Check the entry (log number), date and time, level, event name, event code, and detailed error code.

- Filter the displayed items by selecting the desired items in the **Displayed Information** and **Level** areas.

# 3-6 Data Tracing

Use data tracing function to sample and display specified drive parameters at a fixed interval.

## ● Executing a Data Trace

- Right-click the **Data Trace Settings** under the trace-target Drive in the Multiview Explorer and select **Add - Data Trace** from the menu.

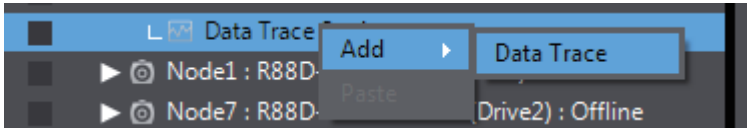

### Precautions for Correct Use

Sysmac Studio provides two data tracing functions, one is for Drives described in this section and the other is for Controllers. Refer to the *Sysmac Studio Version 1 Operation Manual* (Cat. No. W504) for the data tracing function for Controllers.

- Double-click **DataTrace0** that was created by the above operation.

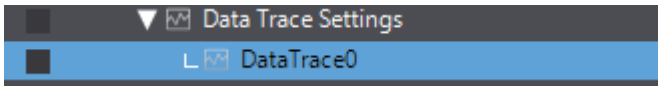

### Additional Information

More than one data trace can be added for each Drive.

- The following Data Trace tab page is displayed.

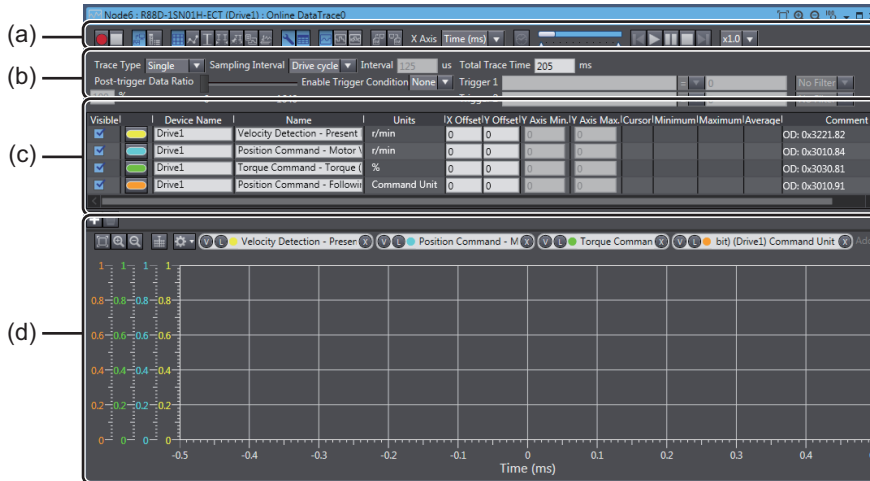

The tab page consists of the following areas.

Item	Description
(a) Toolbar	Buttons to start and stop tracing and display various items are displayed.
(b) Trace setting area	Set the trace conditions.
(c) Trace target area	Specify the trace targets.
(d) Graph area	Graphs of trace results are displayed. The upper part displays the analog values and the lower part displays the digital values.

● **Setting Data Trace Conditions**

Set the data trace conditions. ((b) Trace setting area)

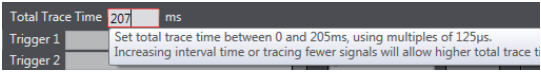
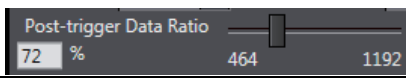
Item	Description	Settings
Trace Type	Select the trace type from the two options on the right.	<ul style="list-style-type: none"> <li>• Single: Data tracing is executed only once.</li> <li>• Cyclic: Data tracing is repeatedly executed according to the same settings. After loading the trace data, Sysmac Studio automatically waits for the next trigger to restart the tracing.</li> </ul>
Sampling Interval	Select the sampling interval from the two options on the right.	<ul style="list-style-type: none"> <li>• Drive cycle: The minimum operating cycle of the Drive is applied. (Example: 0.25 ms for G5 Series and 0.125 ms for 1S Series)</li> <li>• Time: The time that you enter in the <b>Interval</b> field is set as the sampling interval.</li> </ul>
Interval	Enter the sampling interval in $\mu$ s.	<ul style="list-style-type: none"> <li>• Enter a multiple of the Drive's minimum cycle in the <b>Interval</b> field. Minimum cycle of 1S-series Servo Drives: 125 <math>\mu</math>s Minimum cycle of G5-series Servo Drives: 250 <math>\mu</math>s</li> <li>• The value of <b>Total Trace Time</b> can be changed only for 1S Series. The total trace time varies by the total data size of sampling<sup>*1</sup>.</li> </ul> <div style="border: 1px solid black; padding: 5px; margin-top: 10px;"> <p> <b>Additional Information</b></p> <p>If an invalid value is set, the field is highlighted in red. When the mouse cursor is placed over the field, the valid setting range is displayed.</p>  </div>
Total Trace Time	Enter the trace time from start to end in ms.	
Post-trigger Data Ratio	Set the ratio of data to be sampled before and after the specified trigger conditions are satisfied in percentage.	<ul style="list-style-type: none"> <li>• Enter the percentage of post-trigger data or move the slider to set the desired value.</li> </ul> 
Enable Trigger Condition	Set the trigger conditions for starting the sampling in the data trace.	<ul style="list-style-type: none"> <li>• None: Sampling is started at the same time as the start of data tracing.</li> <li>• Trigger 1: Sampling is started according to the condition set as Trigger 1.</li> <li>• Trigger 2: Sampling is started according to the condition set as Trigger 2.</li> <li>• Trigger 1 and Trigger 2 Sampling is started when the conditions set as Trigger 1 and Trigger 2 are satisfied at the same time.</li> <li>• Trigger 1 or Trigger 2 Data tracing is started when either of the conditions set as Trigger 1 or Trigger 2 is satisfied.</li> </ul>

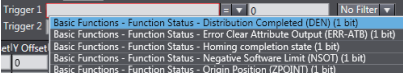

Item	Description	Settings
Trigger 1/ Trigger 2	Set a trigger condition for saving the sampled data.  Set only the triggers that you selected as a trace condition.	<ul style="list-style-type: none"> <li>• Entering a parameter Enter the data to be used as a trigger. Candidates will be displayed by pressing the <b>Ctrl</b> key and space key at the same time when the field is empty.</li> </ul>  <ul style="list-style-type: none"> <li>• Comparison operator Select a comparison operator from the drop-down list. G5 Series: =, ≠, &lt;, &gt;, Rising, and Falling 1S Series: =, ≠, ≤, ≥, &lt;, &gt;, Rising (Including level/Not including level), and Falling (Including level/Not including level)</li> <li>• Filter settings When setting an analog value as a trigger condition, you can prevent wrong trigger detection caused by chattering by calculating the moving average of the present value and past values using the filtering function.  (You can specify up to last 8 data items for G5 Series and last 16 data items for 1S Series.)</li> </ul>

\*1. Data size of each sampled data is displayed at the end of the data in the data trace setting area. (Example: Position Command - Motor Velocity (16 bit))

## ● Setting the Data to Sample

Set the sampling target data of the data trace. ((c) Trace target area).

### 1 Adding/Deleting Data to Sample

- Add: Click the  button. A row is added at the bottom of the table.
- Delete: Select the row to delete and click the  button.



#### Additional Information

The four frequently used parameters are pre-registered by default.

### 2 Specifying Data to Sample

Enter the name of data to sample in the **Name** field.



#### Additional Information

Candidates will be displayed by pressing the **Ctrl** key and space key at the same time in the **Name** field when it is empty.



#### Precautions for Correct Use

As sampling data, up to six data items can be specified for 1S Series regardless of the data size. For G5 series, up to four data items can be specified (i.e., up to 64 bits in total when only 16-bit data items are specified).

## ● Setting the Details of Data to Sample

The following items can be displayed and set in the trace target area (c) as details of each data item to sample.

Column	Description	Edit
Visible	Select whether to show or hide the item.	Possible
Line Color	Select a graph color.	Possible
Device Name	Select the device name of the EtherCAT slave. (only for 1S Series)	Possible
Name	The name of the data to sample is displayed. Select the name from the candidates.	Possible
Units	The unit of the data to sample is displayed.	Not possible
X Offset	The offset of the X axis in the graph is displayed. Set the offset.	Possible
Y Offset	The offset of the Y axis in the graph is displayed. Set the offset.	Possible
Y Axis Min.	The minimum value of the Y axis in the graph is displayed.	Not possible
Y Axis Max.	The maximum value of the Y axis in the graph is displayed.	Not possible
Cursor	The cursor values at the time the range cursors are enabled are displayed.	Not possible
Minimum	The minimum value of the sampled data is displayed.	Not possible
Maximum	The maximum value of the sampled data is displayed.	Not possible
Average	The average value of the sampled data is displayed.	Not possible
Comment	The index and subindex of the sampled data are displayed.	Not possible

## ● Starting/Ending a Data Trace

- Starting a Data Trace
  - Click the  button in the Toolbar.
- Ending a Data Trace

Data tracing automatically finishes when it is completed according to a specified condition. To finish the tracing before completion, click the  button.

● **Checking Data Trace Results**

- Checking the Trace Results with a Graph

The traced data are displayed in the graph area (d).

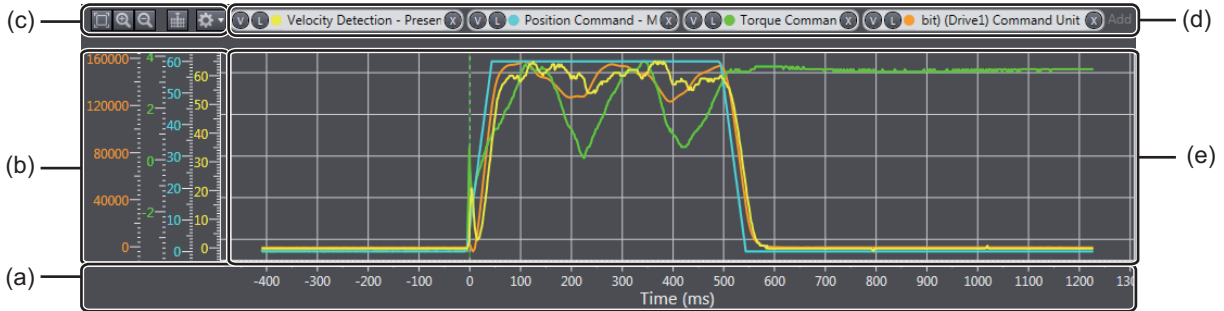

The graph area consists of the following items.

Item	Description
A. X axis (ms)	The time is displayed always in ms.
B. Y axis	The values of each data trace target are displayed individually.
C. Graph tools	Buttons to zoom in and out, fit to the pane width, display the cursor on the graph, and manage Y Axis scales are displayed.
D. Y axis setting area	The data trace targets assigned to the Y axis are displayed. Specify the display area of each scale for Y axis.
E. Graph	The data trace results are displayed.

- Registering Multiple Scales for Y Axis (Multi-scale Y Axis Setting)

More than one sampled data item can be displayed with different scales by registering the data as scales for Y axis.

- Registering a scale manually

Click the *Click to add scale, or drag from table.*

Enter a data trace target. Candidates will be displayed by pressing the **Ctrl** key and space key in the entry field when it is empty.

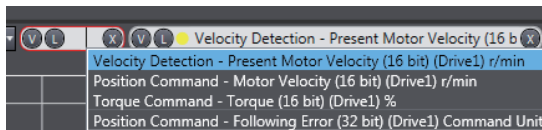



- Dragging from the trace target data area.

Click and drag a row for the item that you want to trace and drop it onto the *Click to add scale, or drag from table.*

- Deregistering a scale.

To deregister a scale from the Y axis, click the  button in the Y axis settings area.

- Selecting a display area.

To switch the side to display each scale, click the  or  button in the Y axis setting area.

**L** button: Displays the scale on the left side of the graph area (default)

**R** button: Displays the scale on the right side of the graph area

- Using Graph Tools

- Zoom In and Zoom Out

To zoom in and zoom out the graph area, click the  buttons or turn the scroll wheel of the mouse.

- Zoom to Fit

All graphs are automatically adjusted to fit in the current graph area. Click the  button.



### Additional Information

---

Only the sampled data with the scale for Y axis registered are subject to the auto adjustment.

---

- Displaying a Cursor

To display the cursor to show the present value, click the  button.

- Managing Y Axis Scales

Click the  button to operate with Y axis scales.

**Open...** : Restores previously saved scale settings.

**Save...** : Saves current scale settings.





**Assign all signals**: Registers all signals as scales.

**Unassign all signals**: Deregisters all scales.

**Group by unit**: All signals with the same unit type are registered into the same scale.













### ● Switching the View in the Graph Area

To select whether to show or hide each chart in the graph area, click the following buttons in the Toolbar.

Icon	Tooltip	Description
	Show Configuration	Displays the trace settings.
	Show Data Table	Displays the trace targets.
	Show Analog Chart	Displays the analog chart in the graph area.
	Show Digital Chart	Displays the digital chart in the graph area.
	Show Digital On Analog Chart	Displays the analog and digital charts in the same graph area.

### ● Using the Convenient Functions for the Graph Area

Some other convenient functions are provided for the graph area. Use the functions by clicking the following buttons in the Toolbar.

Icon	Tooltip	Description
	Transfer Parameters from Drive after Trace	Uploads the trace results and settings from the Drive. Normally, this is automatically executed when the trace is completed. Also, you can manually upload them by clicking this button.
	Open Properties	Displays the Properties pane.
	Switch Layout	Changes the display position of the trace target table to above or to the left of the graphs.
	Save as History	Saves the displayed graph data as history.
	Show History	Displays the graph data saved as history.
	Show Grid	Displays a grid in the graph area.
	Show Markers	Highlights sampling points in the graph area.
	Show Cursor	Displays a cursor to check the value of the parameter selected in the graph. The cursor can be moved right and left with a mouse.
	Show Range Cursors	Displays cursors to see the difference between specified two points.
	Make Range Cursor Fixed Width	Fixes the distance between two cursors when the range cursors are displayed.
	Show Legends	Displays legends in the graph area.
	Independent Y Axis Mode	Uses a common scale for Y axis in the graph area. When a data item is selected in the trace data table, the item's scale is used as the common scale for the Y axis.  When the independent Y axis mode is enabled, the current multi-scale settings for the Y axis are cleared.



### ● Using Data Trace Properties

In the Properties pane, check the configuration of the traced data, trace target drive, and parameters at the time of data trace execution. Also, the parameters at the time of tracing can be applied to the project. To open the Properties pane, click the  in the Toolbar.

- Comment  
Enter a comment for the data trace.
- Configuration  
The interval and total trace time set for the data trace are displayed.
- Parameters  
A list of the parameters set in the Servo Drive at the time of data trace execution is displayed. Clicking the **Update Project** button transfers the current parameter values from the Drive to the project.



#### Additional Information

---

When multi-drive data tracing is executed, parameters of up to four nodes are displayed.

---

### ● Saving Data Trace Results to the Project

After data tracing, you can save the data to a project. Data is saved on a data trace basis.

- Opening the saved trace data  
Open a Sysmac Studio project and double-click a data trace in the Multiview Explorer. The following message is displayed. Click the **Yes** button.

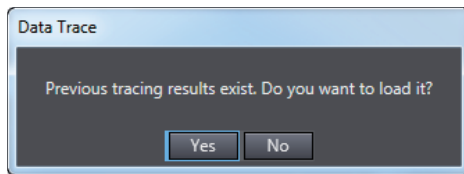

## ● Exporting/Importing Data Trace Results

- Export

The settings and data of each data trace are exported into a csv file. Click the  button in the Toolbar and specify a file.

- Import

The csv files that were previously exported are imported. Use the following two procedures according to your purpose.

- (1) Superimposing a data trace graph

The trace settings and sampled data are superimposed on the current data trace. You can display the data with the current data trace results.

- 1) Open the original data trace on which the data should be superimposed.
- 2) Click the  button and specify the exported file.



### Precautions for Correct Use

- Only the files that were output by the above-mentioned export function can be imported.
- The trace conditions are not imported.
- The imported trace settings cannot be re-edited. They are grayed out in the edit pane as shown below.

Visible	Device Name	Name	Units	IX O
<input checked="" type="checkbox"/>	Drive1	Velocity Detection - Present	r/min	0
<input checked="" type="checkbox"/>	Drive1	Position Command - Motor	r/min	0
<input checked="" type="checkbox"/>	Drive1	Torque Command - Torque	%	0
<input checked="" type="checkbox"/>	Drive1	Position Command - Followi	Command Unit	0
<input checked="" type="checkbox"/>	Drive1	Velocity Detection - Present	r/min	0
<input checked="" type="checkbox"/>	Drive1	Position Command - Motor	r/min	0
<input checked="" type="checkbox"/>	Drive1	Torque Command - Torque	%	0
<input checked="" type="checkbox"/>	Drive1	Position Command - Followi	Command Unit	0

- (2) Reusing the Data Trace Settings

The trace conditions, trace settings, and sampled data of the exported data trace at the time of data tracing are restored as is.

- 1) Delete all of the sampling target data in the trace settings.
- 2) Click the  button and specify a file that was previously exported.



### Precautions for Correct Use

- Only the files that were output by the above-mentioned export function can be imported.
- If one or more parameters are registered in the trace settings, the data is imported like the superimposing function.

### ● Executing Data Tracing by Multiple Drives (only for 1S Series via NJ/NX/NY controller)

You can synchronize the sampling start timing across multiple Drives to execute data tracing at the same time. Enter the trace target device name in the **Device Name** column in the trace data area (c) and set the data to sample. Other settings and execution procedures are the same as single data tracing.



#### Precautions for Correct Use

---

- Execute the data tracing from the view for the Drive for which you set the triggers.
- Enter the node name on the ECAT editor in the **Device Name** column. (The default node names are an E followed by a sequential number starting from 001 like *E001* and *E002*.)
- Data tracing can be performed for up to four Drives including the device that detects the trigger. If five or more Drives are set for the trace targets and data tracing is started, the following message will be displayed.

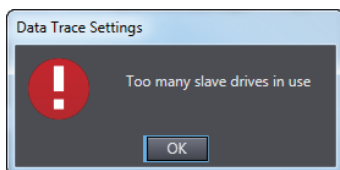

- The sampling data between the Drives is not synchronized if you set the sampling interval longer than EtherCAT PDO communication cycle.
- 



#### Precautions for Correct Use

---

- If you change any data settings when a graph is displayed after data tracing is completed and then export the data, the results will not be consistent with the settings in the exported data.
  - The exported CSV file of trace results is encoded in UTF-8 character codes.
  - When you import a CSV file, specify the CSV file to which the Drive trace results were exported.
  - If the CSV file is edited after it was exported, it may not be possible to import it.
-

## 3-7 Motors and Encoders

Set the motor's status display and encoders.

- **Open the Motor and Encoder Properties tab page**

Right-click the Drive and select **Motor and Encoder** from the menu.

### 3-7-1 Motor Properties

Confirm the motor properties.

- **Displaying the Motor Properties**

Click the **Motor Properties** (  ) button. When Sysmac Studio is online with the Drive, the following properties of the connected motor are displayed.

Item	Value
Motor ID	Motor's model number
Serial Number	Motor's serial number
Capacity	Motor capacity
Speed	Rated speed
Voltage	Rated voltage
Encoder	Encoder type

## 3-7-2 Encoder Properties

This section describes how to monitor the encoder status and initialize the encoder.

### ● Displaying the Encoder Properties

Click the **Encoder Properties** (  ) button. When Sysmac Studio is online with the Drive, the encoder properties can be confirmed and the functions for the properties can be executed.

### ● Confirming the Encoder Status

Encoder status information is displayed in the **Monitor** area of the Encoder Properties tab page.

### ● Setting up the Encoder

If an error occurred in the encoder when a motor with an absolute encoder was used, you need to set up the encoder using the **Operations** function in the Encoder Properties tab page.

- Clearing the system.

Click the **Clear system** button to clear the multiple rotation data of the encoder.

- Resetting alarms

Click the **Reset alarm** button to clear the current alarms in the encoder.

A list of current alarms is displayed with their event names and error codes.

- Resetting the communications error count (only for 1S Series)

Click the **Reset Communications Error Count** button to clear the number of communication errors that occurred in the encoder.

- Resetting the motor replacement detection error (only for 1S Series)

Click the **Reset Motor Replacement Detection error** button to clear the motor replacement detection error.



### Precautions for Correct Use

- For 1S Series, the following message is displayed when you execute the system clear operation. Click the **Yes** button to restart the Drive. After restarting the Drive, reset the errors using the Troubleshooting function of the Controller.

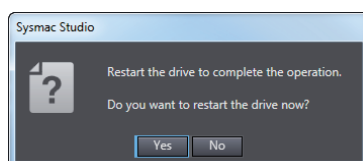

- For G5 Series, after executing the system clear operation, you need to reset errors using the Troubleshooting function of the Controller or cycle the power supply to the Drive.



### Precautions for Safe Use

If the absolute encoder setting function is executed, the multiturn counter and encoder alarm are reset in the absolute serial encoder. When the multiturn counter in the absolute encoder is reset to 0, the previously defined machine system changes to a different coordinate system. After the encoder is set normally, reset the zero point of the mechanical system.

## 3-8 Setup and Tuning Wizard

### 3-8-1 Overview

The Setup and Tuning wizard enables quick parameter setup and monitoring, access to the Test Run features and a choice of tuning functions.

Click the Drive and select **Setup and Tuning** from the menu.

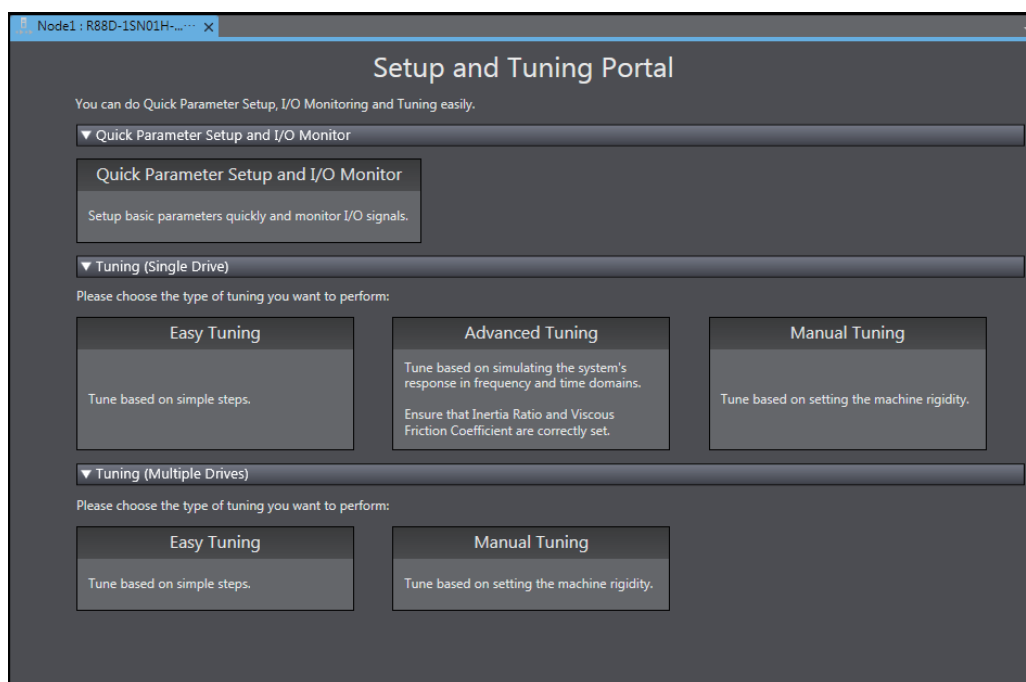

The portal page of the Setup and Tuning wizard has the following buttons.

Button	Function	Connection type
Quick Parameter Setup and I/O Monitor	You can set and transfer basic parameters (mainly for assigning functions to external I/O signals), monitor the I/O signals, and perform a test run.	Any
Tuning (Single Drive)	The following three kinds of tuning methods are provided for single Drive. <ul style="list-style-type: none"> <li>• Easy tuning</li> <li>• Advanced tuning</li> <li>• Manual tuning</li> </ul>	Any
Tuning (Multiple Drives)	The following two kinds of tuning methods are provided for multiple Drives. <ul style="list-style-type: none"> <li>• Easy tuning</li> <li>• Manual tuning</li> </ul>	<ul style="list-style-type: none"> <li>• EtherCAT connection via an NJ/NX/NY-series CPU Unit</li> <li>• EtherCAT connection via a Programmable Multi-Axis Controller</li> </ul>

## 3-8-2 Quick Parameter Setup and I/O Monitor

Click the **Quick Parameter Setup and I/O Monitor** button.

In the Quick Parameter Setup and I/O Monitor tab page, set and transfer the parameters that are required for startup, monitor the I/O signals, and perform a test run.

### Step 1: Motor and Encoder Setting

When you use an absolute encoder, set up the encoder.

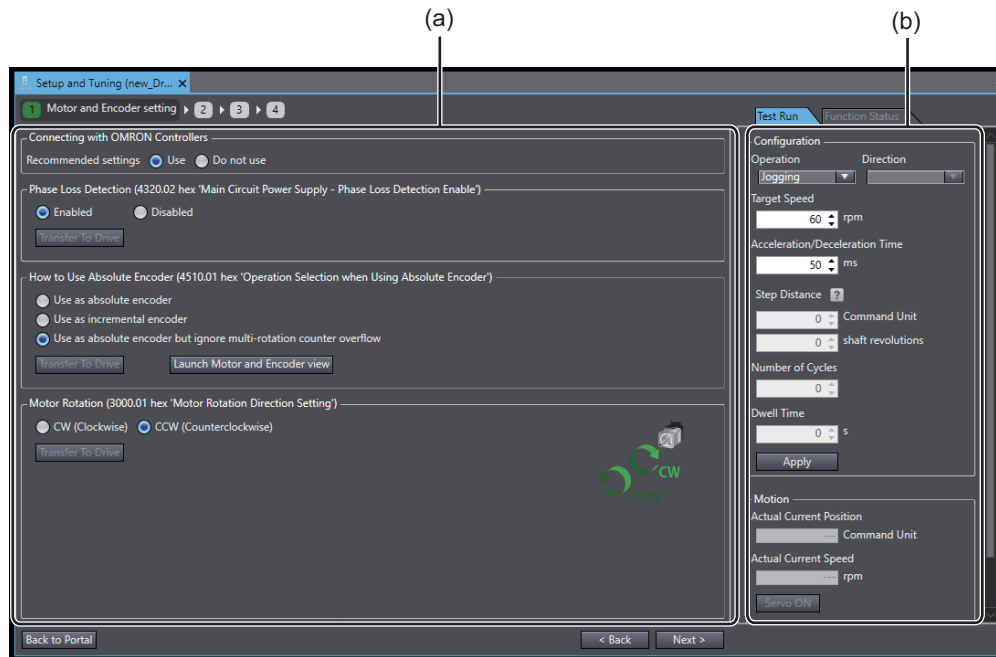

No.	Item	Description
(a)	Setting area	Set up the absolute encoder. Then, make the settings of input and output signals.
(b)	Test Run tab page	Perform a test run, monitor the I/O signals, and forcibly change the status of the signals.

#### ● Step 1-1: Selecting Whether or not an OMRON Controller is Connected

Select *Use* when you use an OMRON Controller. Otherwise, select *Do not use*.

When *Use* is selected, recommended setting values for the OMRON Controller are applied.

#### ● Step 1-2: Selecting Usage of the Absolute Encoder

Select the usage of the absolute encoder connected to the Servo Drive.

**1** Select one of the following options in the **How to Use Absolute Encoder** area.

- Use as absolute encoder
- Use as incremental encoder
- Use as absolute encoder but ignore multi-rotation counter overflow

**2** Click the **Transfer To Drive** button to transfer the selected settings to the Drive. The transferred settings are applied after the Drive is restarted. Restart the Drive according to the specified procedure.

### ● Step 1-3: Setting up the Absolute Encoder

To set up the absolute encoder, click the **Launch Motor and Encoder view** button. Refer to *3-7 Motors and Encoders* on page 3-34 for details.

### ● Step 1-4: Selecting the Motor Rotation Direction and Transferring the Settings

- 1** Select the motor's rotation direction for positive commands in the **Motor Rotation** area.
  - CW (Clockwise)
  - CCW (Counterclockwise)
- 2** When you transfer the selected settings to the Drive, click the **Transfer To Drive** button. The transferred settings are applied after the Drive is restarted. Restart the Drive according to the specified procedure.

### ● Step 1-5: Performing a Test Run

Perform a test run to confirm that the correct motor rotation direction is set. Refer to *3-8-3 Test Run and Function Status* on page 3-45 for details.

When all the settings and the transfer operation are completed, click the **Next** button.



## Step 2: Input Signals Setting

Set the function assignment and monitor the current status of external inputs to the Drive.

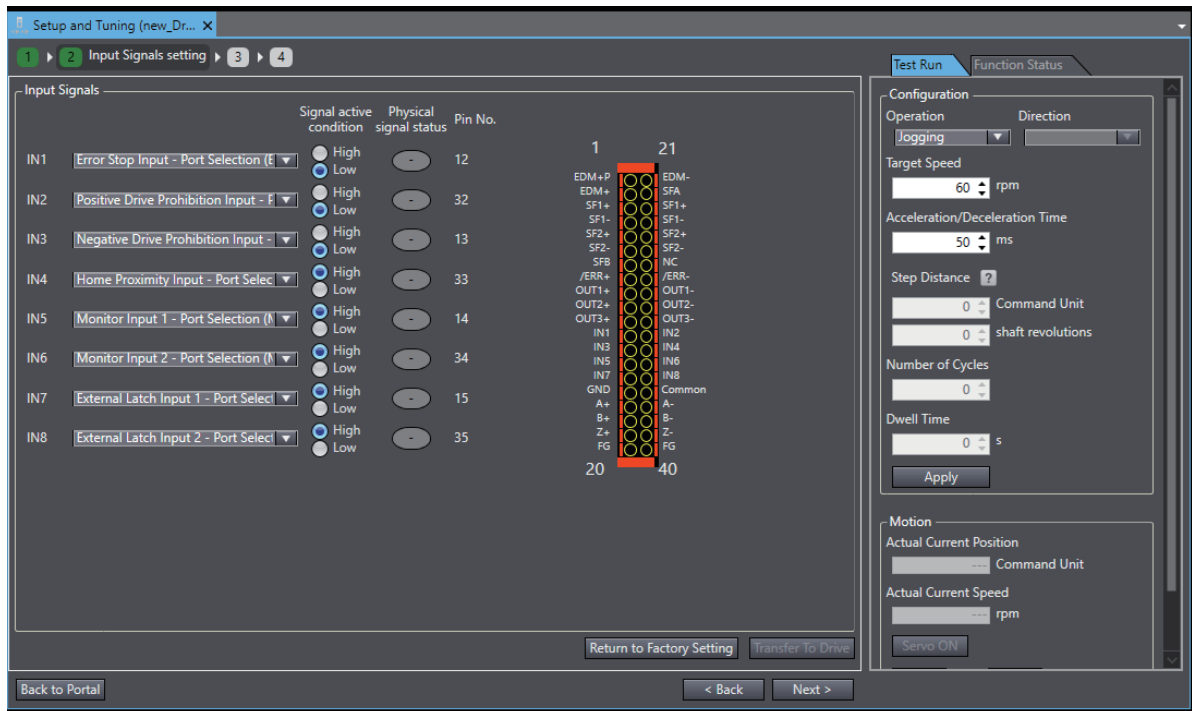

### ● Step 2-1: Setting the Function Assignment to External Inputs

In the **Input Signals** area, make the function assignment settings for external inputs.

- 1 Assign a function each to input terminals IN1 to IN8.
- 2 Set the signal active condition.  
Low: Positive (NO), High: Negative (NC)

### ● Step 2-2: Monitoring the Current Status of each External Input

Monitor the current status of each physical signal by checking the **Physical signal status** or terminal display.

Also, monitor the status of the functions assigned to each terminal in the Function Status tab page.

### ● Step 2-3: Returning to Factory Settings

Click the **Return to Factory Setting** button. Then, the input signals are reset to the factory settings.

### ● Step 2-4: Transferring the Settings to the Drive and Restarting the Drive

When you transfer the selected settings to the Drive, click the **Transfer To Drive** button. The transferred settings are applied after restarting the Drive. Restart the Drive according to the specified procedure.

### ● Step 2-5: Checking the Wiring and Settings of the Input Terminals

In the Function Status tab page, you can perform a test run to see if the wiring to the input terminals and functions and signal active conditions of the input terminals are correct. Refer to *3-8-3 Test Run and Function Status* on page 3-45 for details.

When all the settings and the transfer operation are completed, click the **Next** button.

## Step 3: Output Signals Setting

Set the function assignment and monitor the current status of external outputs from the Drive.

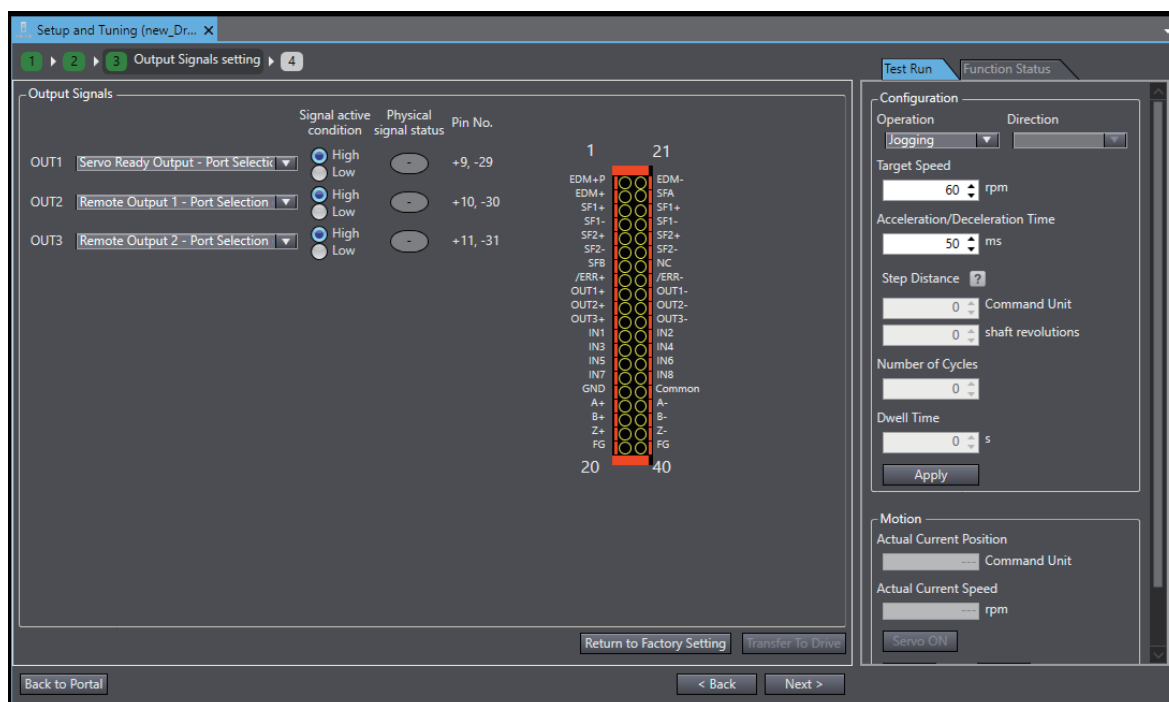

### ● Step 3-1: Setting the Function Assignment to External Outputs

In the **Output Signals** area, make the function assignment settings for external outputs.

- 1 Assign an object (i.e., function) each to output terminals OUT1 to OUT3.
- 2 Set the signal active condition.  
Low: Positive (NO), High: Negative (NC)

### ● Step 3-2: Monitoring the Current Status of each External Output

Monitor the current status of each physical signal by checking the **Physical signal status** or terminal display.

Also, monitor the status of the functions assigned to each terminal in the Function Status tab page.

### ● Step 3-3: Returning to Factory Settings

Click the **Return to Factory Setting** button. Then, the output signals are reset to the factory settings.

### ● Step 3-4: Transferring the Settings to the Drive and Restarting the Drive

Click the **Transfer To Drive** button. Only the output signal settings are transferred to the Drive and the Drive is restarted.

### ● Step 3-5: Performing a Test Run

You can perform a test run to see if the functions and signal active conditions of the output terminals are correct.

### ● Step 3-6: Checking the Wiring and Settings of the Output Terminals

In the Function Status tab page, you can perform a test run to see if the wiring to the output terminals and functions and signal active conditions of the output terminals are correct. Also, you can forcibly turn ON and OFF the output terminals from Sysmac Studio. Refer to 3-8-3 *Test Run and Function Status* on page 3-45 for details.

## Step 4: Finish

A list of parameter values set as the result of changes in previous steps is displayed.

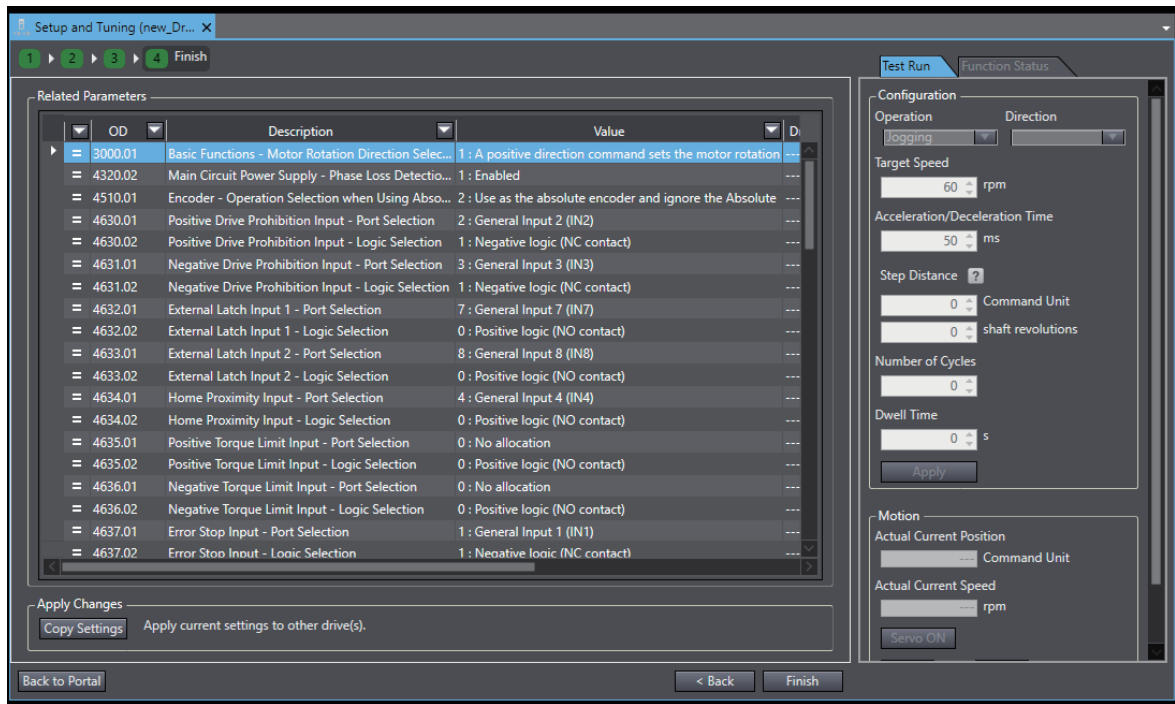

### ● Step 4-1: Checking the Related Parameters

Check the setup results of the parameters.

### ● Step 4-2: Copying the Settings

Click the **Copy Settings** button to copy the related parameters to other Drives. Refer to 3-1-1 *Displaying and Editing Drive Parameters* on page 3-2 for details.

When the settings are completed, click the **Finish** button. The portal page of the Setup and Tuning wizard will be displayed.

## Objects Set by Quick Parameter Setup

The following parameters are set by the setup.

Index (hex)	Subindex (hex)	Name
3000	---	Basic Functions
	01	Motor Rotation Direction Selection
4320	---	Main Circuit Power Supply
	02	Phase Loss Detection Enable
4510	---	Encoder
	01	Operation Selection when Using Absolute Encoder
4630	---	Positive Drive Prohibition Input
	01	Port Selection
	02	Logic Selection
4631	---	Negative Drive Prohibition Input
	01	Port Selection
	02	Logic Selection
4632	---	External Latch Input 1
	01	Port Selection
	02	Logic Selection
4633	---	External Latch Input 2
	01	Port Selection
	02	Logic Selection
4634	---	Home Proximity Input
	01	Port Selection
	02	Logic Selection
4635	---	Positive Torque Limit Input
	01	Port Selection
	02	Logic Selection
4636	---	Negative Torque Limit Input
	01	Port Selection
	02	Logic Selection
4637	---	Error Stop Input
	01	Port Selection
	02	Logic Selection
4638	---	Monitor Input 1
	01	Port Selection
	02	Logic Selection
4639	---	Monitor Input 2
	01	Port Selection
	02	Logic Selection
463A	---	Monitor Input 3
	01	Port Selection
	02	Logic Selection
463B	---	Monitor Input 4
	01	Port Selection
	02	Logic Selection
463C	---	Monitor Input 5
	01	Port Selection
	02	Logic Selection
463D	---	Monitor Input 6
	01	Port Selection
	02	Logic Selection

Index (hex)	Subindex (hex)	Name
463E	---	Monitor Input 7
	01	Port Selection
	02	Logic Selection
463F	---	Monitor Input 8
	01	Port Selection
	02	Logic Selection
4650	---	Error Output
	01	Port Selection
	02	Logic Selection
4651	---	Servo Ready Output
	01	Port Selection
	02	Logic Selection
4652	---	Positioning Completion Output 1
	01	Port Selection
	02	Logic Selection
4653	---	Positioning Completion Output 2
	01	Port Selection
	02	Logic Selection
4654	---	Velocity Attainment Detection Output
	01	Port Selection
	02	Logic Selection
4655	---	Torque Limit Output
	01	Port Selection
	02	Logic Selection
4656	---	Zero Speed Detection Output
	01	Port Selection
	02	Logic Selection
4657	---	Velocity Conformity Output
	01	Port Selection
	02	Logic Selection
4658	---	Warning Output 1
	01	Port Selection
	02	Logic Selection
4659	---	Warning Output 2
	01	Port Selection
	02	Logic Selection
465A	---	Velocity Limiting Output
	01	Port Selection
	02	Logic Selection
465B	---	Error Clear Attribute Output
	01	Port Selection
	02	Logic Selection
465C	---	Remote Output 1
	01	Port Selection
	02	Logic Selection
465D	---	Remote Output 2
	01	Port Selection
	02	Logic Selection
465E	---	Remote Output 3
	01	Port Selection
	02	Logic Selection

Index (hex)	Subindex (hex)	Name
465F	---	Zone Notification Output 1
	01	Port Selection
	02	Logic Selection
4660	---	Zone Notification Output 2
	01	Port Selection
	02	Logic Selection
4661	---	Position Command Status Output
	01	Port Selection
	02	Logic Selection
4662	---	Distribution Completed Output
	01	Port Selection
	02	Logic Selection
4663	---	External Brake Interlock Relay Output
	01	Port Selection <sup>*1</sup>
	02	Logic Selection <sup>*1</sup>

\*1. Revised in Servo Drive Unit Version 1.2 or later.

### 3-8-3 Test Run and Function Status

You can perform a test run, monitor I/O signals, and forcibly turn ON and OFF output signals. These operations can be performed while the Drive is in Test Run mode.

## Test Run

Perform a test run from the Test Run tab page.

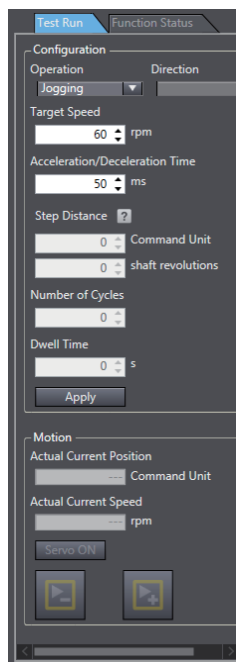

- 1** Select *Jogging* or *Step* for **Operation** to set the operation pattern.
- 2** Run the motor while checking the values of **Actual Current Position** and **Actual Current Speed**.



#### ● Step 1: Turning ON the Servo Drive

Click the **Servo ON** button to turn ON the Servo Drive.

#### ● Step 2: Jogging

- 1** Select *Jogging* for **Operation**.
- 2** Set the target speed and acceleration/deceleration time.
- 3** Click the **Apply** button.
- 4** Click and hold the  button or the  button. While you hold one of the buttons, jogging is performed.

- **Step 2: Stepping**

- 1** Select *Step* for **Operation**.
- 2** Select the rotation direction from *Forward > Reverse*, *Reverse > Forward*, *Forward*, or *Reverse*.
- 3** Set the target speed, acceleration/deceleration time, step distance, number of cycles, and dwell time.
- 4** Click the **Apply** button.
- 5** Click the  button. The step operation is started.

- **Step 3: Checking the Current Operation**

In the **Motion** area, the actual current position and actual current speed are displayed.

- **Step 4: Stopping the Motor**

When you want to stop the motor during the step operation, click the  button.



## Monitoring the I/O Signals and Forcibly Changing the Status of Output Signals

In the Function Status tab page, you can monitor the input and output signals and forcibly change the status of output signals.

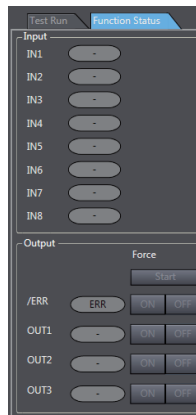

- **Monitoring the Input Signals**

Monitor the status of input signals IN1 to IN8 in the **Input** area.

- **Monitoring the Output Signals and Forcibly Changing the Status of Output Signals**

Monitor the status of output signals OUT1 to OUT3 in the **Output** area. When you forcibly change the status of each signal, select **ON** or **OFF** and click the **Start** button under **Force**.

When the test run is completed, click the **Finish** button. The portal page of the Setup and Tuning wizard is displayed.

### 3-8-4 Easy Tuning (Single Drive)

Click the **Easy Tuning** button in Tuning (Single Drive).

You can easily adjust the gains using the easy tuning function. The optimum gains are automatically attained while repeating the motor operation.

#### Step 1: Configuration

Select *Simple* or *Custom* for the tuning method.

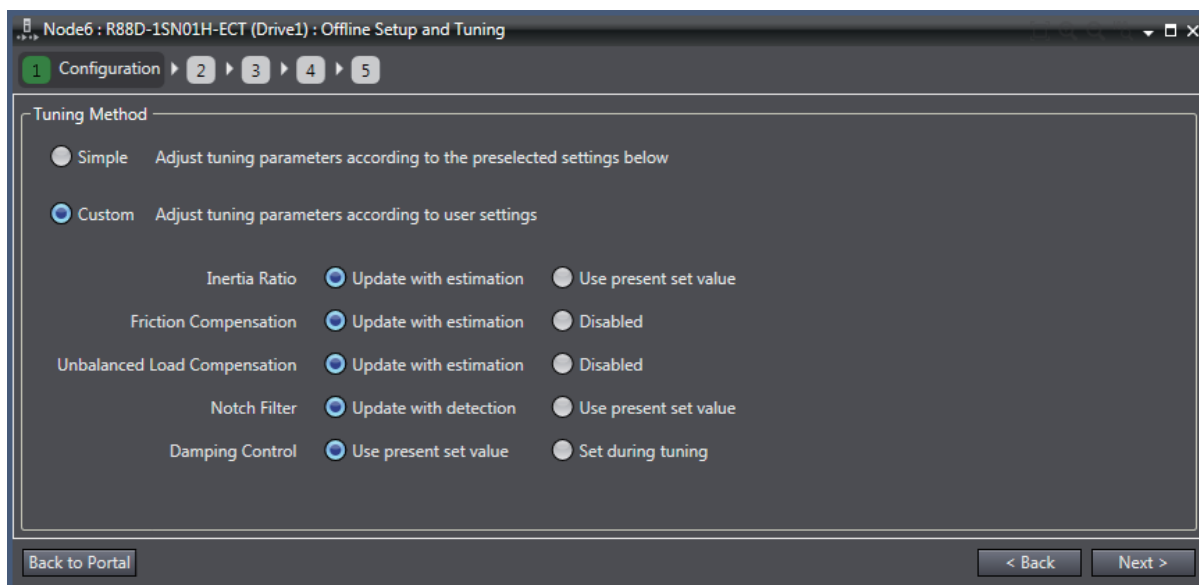

## ● Selecting the Tuning Method

### 1 Select *Simple* or *Custom*.

Simple: Tuning for inertia ratio, torque compensation, and notch filter.

Custom: Tuning based on the selection for the following items.

Item	Option	Description
Inertia Ratio	Update with estimation	The amount of load inertia is automatically estimated and the setting of Inertia Ratio (3001 hex - 01 hex) is updated based on the result.
	Use present set value	The Drive's present setting of Inertia Ratio (3001 hex - 01 hex) is maintained.
Friction Compensation	Update with estimation	The load friction is automatically estimated and the torque compensation settings (Viscous Friction Coefficient (3310 hex - 01 hex), Positive Dynamic Friction Compensation (3310 hex - 03 hex), and Negative Dynamic Friction Compensation (3310 hex - 04 hex)) are updated based on the result.
	Disabled	The torque compensation values (Viscous Friction Coefficient (3310 hex - 01 hex), Positive Dynamic Friction Compensation (3310 hex - 03 hex), and Negative Dynamic Friction Compensation (3310 hex - 04 hex)) are set to 0 to disable the friction compensation.
Unbalanced Load Compensation	Update with estimation	The amount of unbalanced load of the load is automatically estimated and the setting of the torque compensation value (Unbalanced Load Compensation (3310 hex - 02 hex)) are updated based on the result.
	Disabled	The torque compensation value (Unbalanced Load Compensation (3310 hex - 02 hex)) is set to 0 to disable the friction compensation.
Notch Filter	Update with estimation	The resonance frequency of the load is automatically estimated and the settings of Notch Filters (3321 hex to 3324 hex) are updated based on the result. After the tuning, Adaptive Notch Filter (3320 hex - 01 hex) is set to <i>Disabled</i> .
	Use present set value	The Drive's present settings of Adaptive Notch Filter (3320 hex - 01 hex) and Notch Filters (3321 hex to 3324 hex) are maintained.
Damping Control	Use present set value	The Drives present settings of Damping Control (3012 hex to 3014 hex) are maintained.
	Set during tuning	The setting of Damping Control (3012 hex to 3014 hex) is made while adjusting the gain.

Refer to the *1S-series AC Servomotors and Servo Drives User's Manual* (Cat. No. I566) for details of each function.

When the settings are completed, click the **Next** button.

## Step 2: Profile and Criteria

Set the motion profile generator and criteria for finishing auto tuning.

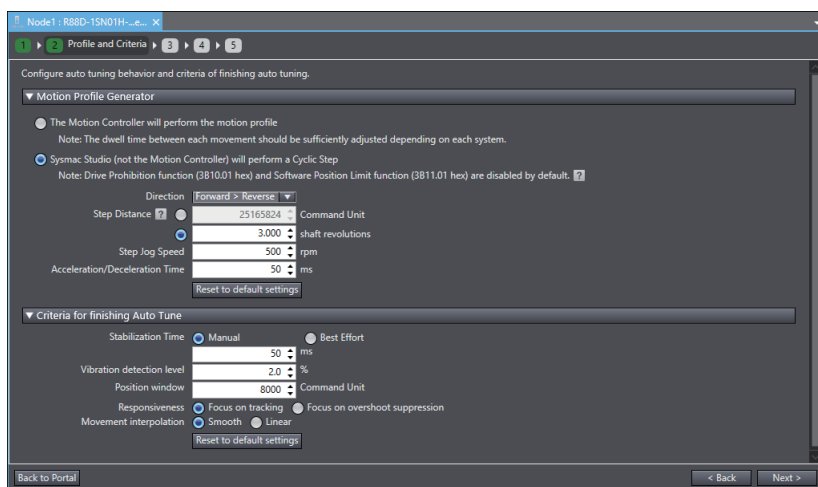

### ● Step 2-1: Selecting the Motion Profile Generator

Select the motion profile generator that generates the commands for running the motor from the following.

- The Motion Controller will perform the motion profile:  
The commands are sent from the Controller of the Drive.
- Sysmac Studio (not the Motion Controller) will perform a Cyclic Step:  
The commands are sent from Sysmac Studio.

When you select this option, set the motor operation direction, step distance, step jog speed, and acceleration/deceleration time.

### ● Step 2-2: Setting the Criteria for Finishing the Auto Tuning

Set the criteria for finishing the auto tuning.

When the conditions set here are satisfied, the tuning is complete.

Item	Option	Description
Stabilization Time	Manual	Set the stabilization time that is applied as the tuning completion condition.
	Best Effort	Although vibration occurs while auto tuning is being performed, Sysmac Studio automatically sets the stabilization time as short as possible within the range that does not cause micro vibration in the Drive.
Vibration detection level		Adjust the gain so that the torque vibration does not exceed this setting value. Set the percentage to the rated torque of the motor. Servo Drive Unit Version 1.0 and 1.1 do not use decimal digit resolution, whereas Servo Drive Unit Version 1.2 or later use 1 decimal digit resolution.
Position window		Set the in-position width used for measuring the stabilization time. This setting value is applied to the Positioning Completion Notification - Positioning Window (3B51 hex - 01 hex).
Responsiveness		Focus on positioning: Priority is given to reducing the stabilization time and following error. Depending on the device and tuning conditions, overshoot may occur. Focus on overshoot suppression: Priority is given to suppression of overshoot in the tuning.

Item	Option	Description
Movement interpolation <sup>*1</sup>		Set the interpolation method for the command in the Cyclic synchronous position mode (csp). Smooth: 2nd order interpolation is applied. Linear: 1st order interpolation is applied.

\*1. Revised in Servo Drive Unit Version 1.2 or later.

When the settings are completed, click the **Next** button.

## Step 3: Auto Tune Monitor

In this step, you start auto tuning.

Trial Number [Times]	1	2	3	4
Stabilization Time [ms]	431	72	53	44
Overshoot [%]	1.0	1.0	0.8	1.2
Speed Proportional Gain 1 [Hz]	16.0	27.4	32.5	38.6
Position Proportional Gain 1 [Hz]	3.1	5.6	6.8	8.2
Inertia Ratio Estimated Value [%]	243	243	243	243
Unbalanced Load Estimated Value [%]	-0.1	-0.1	-0.1	-0.1
Dynamic Friction Estimated Value [%]	1.5	1.5	1.5	1.5
Viscous Friction Estimated Value [%]	31.9			
Command Time [ms]	411			
Tact Time [ms]	1410			
Command Speed [rpm]	500			
Motor Speed [rpm]	505			
Damping 1 Frequency 1 [Hz]	300.0			
Damping 2 Frequency 1 [Hz]	300.0			
Notch 3 Frequency [Hz]	5000.0	5000.0	5000.0	5000.0
Notch 4 Frequency [Hz]	5000.0	5000.0	5000.0	5000.0

### ● Step 1-1: Starting the Tuning

Click the **Start** button.



#### Precautions for Correct Use

When you selected the *Sysmac Studio* (not the Motion Controller) will perform a *Cyclic Step* option in the **Motion Profile Generator** setting, be careful because the motor will start running by clicking the **Start** button.

When the completion criteria are satisfied, torque is saturated<sup>\*1</sup> or torque vibration of the motor is detected, auto tuning is finished.

\*1. Revised in Servo Drive Unit Version 1.2 or later.

## ● Stopping the Tuning

Click the **Stop** button.



### Additional Information

---

When you selected the *The Motion Controller will perform the motion profile* option in the **Motion Profile Generator** setting, send the motion operation commands from the Controller that controls the Drive. If the interval between operation commands is longer than 10 seconds, correct tuning may not be possible.

Depending on the device and tuning conditions, tuning may be aborted if torque vibration or saturation is detected in the motor during the tuning. In that case, take the following measures and perform the tuning again.

- Change the criteria for finishing the auto tuning.  
If the setting values for in-position width and/or stabilization time are too small, it is difficult to satisfy the completion criteria.
  - Increase the machine rigidity.
- 

When the settings are completed, click the **Next** button.

## Step 4: Check Behavior

In this step, you can check the auto tuning results by data tracing.

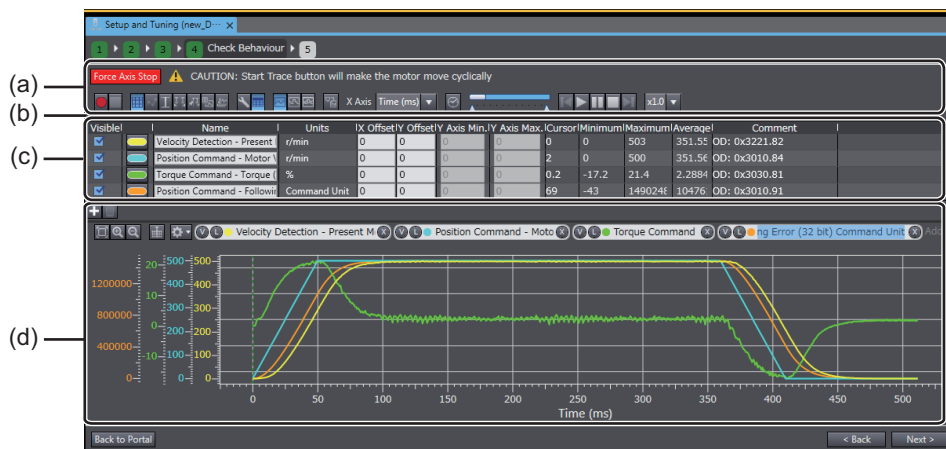

No.	Item	Description
(a)	Toolbar	Buttons to start and stop tracing and display various items are displayed.
(b)	Trace setting area	Set the sampling start conditions. This area is hidden by default.
(c)	Trace target area	Specify the sampling target data.
(d)	Graph area	Trace graphs of sampled data are displayed.

### ● Step 4-1: Setting the Trace Conditions and Trace Target

Refer to 3-6 *Data Tracing* on page 3-24 for details.

### ● Step 4-2: Starting a Trace

Click the **Start Trace** button in the Toolbar (a).



#### Precautions for Correct Use

When you selected the *Sysmac Studio (not the Motion Controller) will perform a Cyclic Step* option in the **Motion Profile Generator** setting, be careful because the motor will start running by clicking the **Start** button.

### ● Step 4-3: Checking the Graphs

The traced data are displayed in the graph area (d).



## Step 5: Finish

A list of parameter values set as the results of auto tuning is displayed.

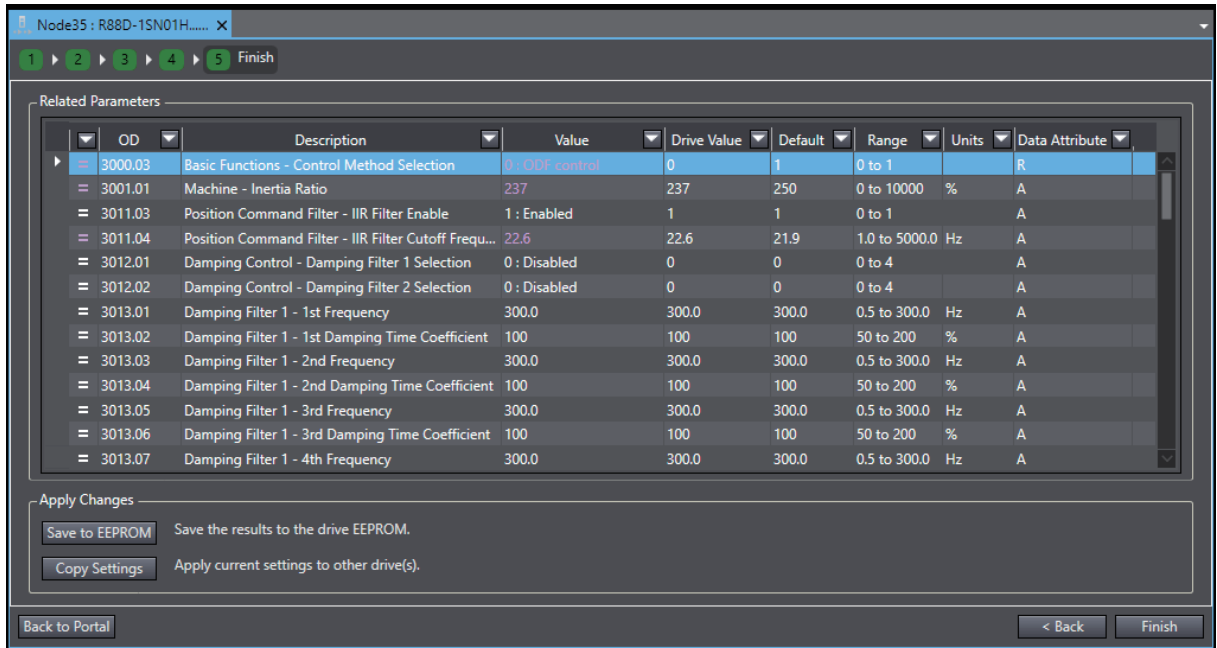

### ● Step 5-1: Checking the Related Parameters

Check the tuning results of the parameters.

### ● Step 5-2: Transferring the Parameter Values after Tuning to the Drive

Click the **Save to EEPROM** button. The related parameters are saved to the non-volatile memory of the Drive.



#### Additional Information

If you finish the tuning without clicking the **Save to EEPROM** button, the tuning results will be lost when the power supply to the Drive is turned OFF.

### ● Step 5-3: Copying the Settings

Click the **Copy Settings** button to copy the related parameters to other Drives. Refer to *3-1-1 Displaying and Editing Drive Parameters* on page 3-2 for details.

When the settings are completed, click the **Finish** button. The portal page of the Setup and Tuning wizard will be displayed.

## Objects Set by Easy Tuning

The following parameters are set by the easy tuning.

### ● Parameters Set to Fixed Values

Index (hex)	Subindex (hex)	Name	Unit	Value
3112	---	ODF Velocity Feed-forward	---	---
	01	Gain	0.1%	300
	02	LPF Enable	---	0
	03	LPF Cutoff Frequency	0.1 Hz	50000
3113	---	ODF Torque Feed-forward	---	---
	01	Gain	0.1%	0
	02	LPF Enable	---	0
	03	LPF Cutoff Frequency	0.1 Hz	50000
3122	---	TDF Velocity Feed-forward	---	---
	01	Gain	0.1%	1000
3123	---	TDF Torque Feed-forward	---	---
	01	Gain	0.1%	1000
3233	---	1st Torque Command Filter	---	---
	01	Enable	---	1
3234	---	2nd Torque Command Filter	---	---
	01	Enable	---	1
3011	---	Position Command Filter	---	---
	03	IIR Filter Enable <sup>*1</sup>	---	1
3B80	---	Load Characteristic Estimation	---	---
	05	Viscous Friction Tuning Coefficient	%	100

\*1. This parameter is set to the fixed value only when two-degree-of-freedom is set.

### ● Objects Changed According to Configuration in Step 1

Index (hex)	Subindex (hex)	Name
3001	---	Machine
	01	Inertia Ratio
3041	---	Command Dividing Function
	10	Interpolation Method Selection in csp <sup>*1</sup>
3120	---	TDF Position Control
	01	Command Following Gain <sup>*2</sup>
	10	Command Following Gain Selection <sup>*2*3</sup>
	11	Command Following Gain 2 <sup>*2*3</sup>
3310	---	Torque Compensation
	01	Viscous Friction Coefficient
	02	Unbalanced Load Compensation
	03	Positive Dynamic Friction Compensation
	04	Negative Dynamic Friction Compensation
3320	---	Adaptive Notch Filter
	01	Adaptive Notch Selection
3321	---	1st Notch Filter
	01	Enable
	02	Frequency
	03	Q-value
	04	Depth
3322	---	2nd Notch Filter
	01	Enable
	02	Frequency
	03	Q-value
	04	Depth
3323	---	3rd Notch Filter
	01	Enable
	02	Frequency
	03	Q-value
	04	Depth
3324	---	4th Notch Filter
	01	Enable
	02	Frequency
	03	Q-value
	04	Depth
3B51	---	Positioning Completion Notification
	01	Positioning Window
3B80	---	Load Characteristic Estimation
	01	Inertia Ratio Update Selection
	02	Viscous Friction Compensation Update Selection
	03	Unbalanced Load Compensation Update Selection
	04	Dynamic Friction Compensation Update Selection

\*1. Revised in Servo Drive Unit Version 1.2 or later.

\*2. This parameter is set to the fixed value only when two-degree-of-freedom is set.

\*3. Revised in Servo Drive Unit Version 1.1 or later.

● **Objects Automatically Adjusted by Auto Tuning Execution in Step 3**

Index (hex)	Subindex (hex)	Name
3213	---	1st Position Control Gain
	01	Proportional Gain
3214	---	2nd Position Control Gain
	01	Proportional Gain
3223	---	1st Velocity Control Gain
	01	Proportional Gain
	02	Integral Gain
3224	---	2nd Velocity Control Gain
	01	Proportional Gain
	02	Integral Gain
3233	---	1st Torque Command Filter
	02	Cutoff Frequency
3234	---	2nd Torque Command Filter
	02	Cutoff Frequency
3011	---	Position Command Filter
	04	IIR Filter Cutoff Frequency <sup>*1</sup>

\*1. This parameter is set to the fixed value only when two-degree-of-freedom is set.

### 3-8-5 Easy Tuning (Multiple Drives)

Click the **Easy Tuning** button in Tuning (Multiple Drives).

You can simultaneously perform Easy tuning on multiple compatible Drives, up to four Drives including the selected Drive.

Except for the functionality described later, the settings, operation, and tuning target parameters are the same as those for single-drive tuning. Refer to *3-8-4 Easy Tuning (Single Drive)* on page 3-48 for detail.

#### ● Start Condition

You can execute this tuning when two or more 1S-series Servo Drives are registered in a controller project. This tuning cannot be executed in a drive project.

#### ● Start Setting

Select drives to be tuned simultaneously.

#### ● Operation Settings

**The Motion Controller will perform the motion profile** is the only option for the command source for motor operation. Operation commands are not sent from Sysmac Studio. So, for tuning, create a program for the controller to send position commands to all the tuning target Drives to perform motor operation.

#### ● Criteria for finishing Auto Tune

Select starting rigidity within the value range from 0 to 20. Select option **Automatic** to apply the default rigidity value of 13 (same as single drive Easy Tuning).

Select the checkbox **Unify trajectory accuracy for all drives** if you want to make it closer to the trajectory of operating command.

## Step 1: Settings

Select *Simple* or *Custom* for the tuning method.

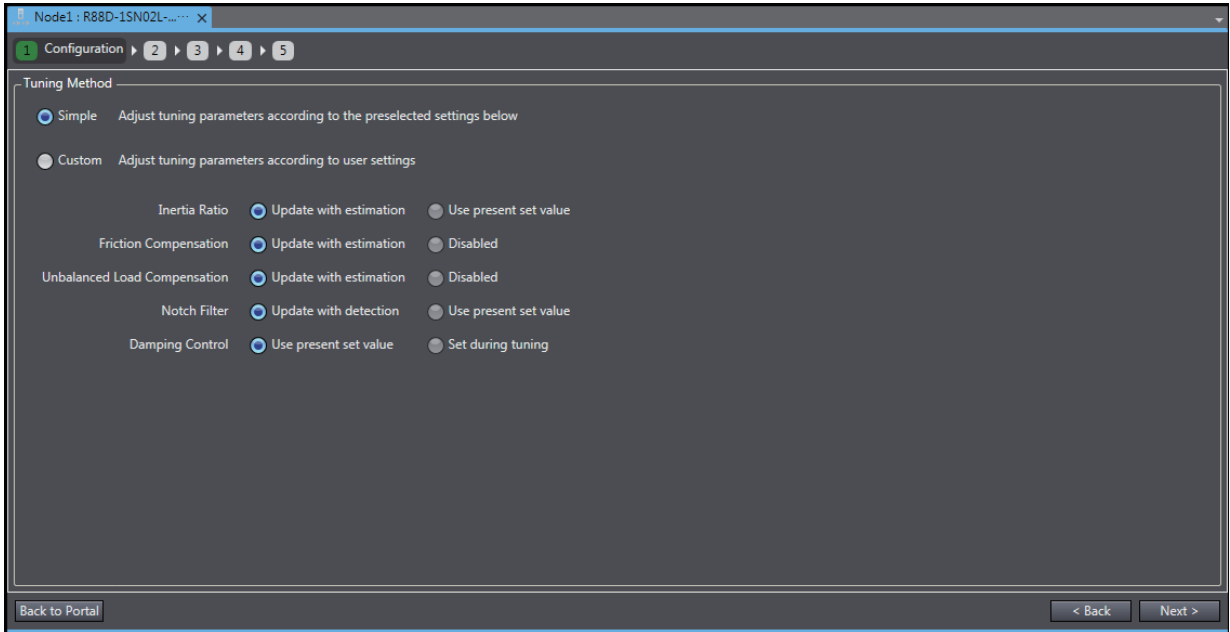

## Step 2: Operation Settings and Criteria for Finishing Tuning

Set the criteria for finishing auto tuning.

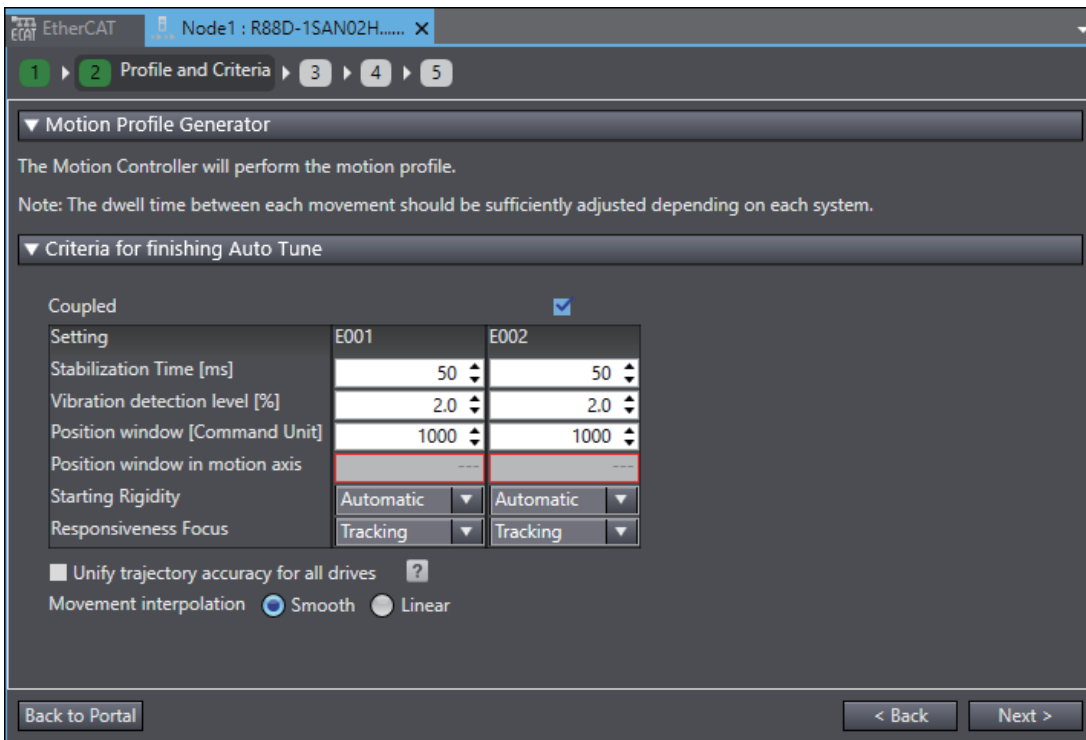



**Additional Information**

**Unify trajectory accuracy for all drives** can be set only when all 1S-series Servo Drives work in the same control method, and the following conditions are met:

- 1S version 1.1 (or later)/1SA version 1.0 (or later) in two-degree-of-freedom
- 1S/1SA (any Unit Version) in one-degree-of-freedom and Responsiveness focusing on Tracking

**Movement interpolation** sets the interpolation method for the command in the Cyclic synchronous position mode (csp). Displayed only when there is at least one 1S-series Servo drives Unit Version 1.2 or later - for 1SA, Version 1.0 or later.

Smooth:  
2nd order interpolation is applied.

Linear:  
1st order interpolation is applied.

### Step 3: Executing Auto Tuning

In this step, you start auto tuning.

The screenshot shows the 'Auto Tune Monitor' window. At the top, there are navigation buttons (1-5) and a 'Start' button. Below the 'Start' button is a note: 'Note: Navigating away from this view when tuning is in progress will stop the operation.' To the right, there is a 'Fix gain settings to any trial' section with a table:

Device Name	Fixed	Trial
E001	<input type="checkbox"/>	1
E002	<input type="checkbox"/>	1

The main part of the interface is a large table with the following columns: Setting, Device Name, Trial ...1, ...2, ...3, ...4, ...5, ...6, ...7, ...8, ...9, ...10.

Setting	Device Name	Trial ...1	...2	...3	...4	...5	...6	...7	...8	...9	...10
Speed Proportional Gain 1 [Hz]	E001	16.0	4.3	8.0	12.7	17.9	22.9	27.3	32.4	38.5	45.7
	E002	16.0	4.3	8.2	13.1	18.3	23.2	27.5	32.7	38.8	46.1
Stabilization Time [ms]	E001	1008	612	320	198	135	102	82	66	53	42
	E002	1008	672	326	193	131	99	81	65	52	41
Overshoot [%]	E001	15.7	0.0	0.0	0.7	0.7	0.8	0.5	0.5	0.5	0.5
	E002	15.8	0.0	0.0	0.8	1.2	0.8	1.0	0.8	0.7	1.0
Inertia Ratio Estimated Value [%]	E001	1176	1178	1177	1176	1177	1177	1178	1178	1178	1178
	E002	1180	1179	1181	1181	1180	1180	1179	1179	1178	1178
Notch 3 Frequency [Hz]	E001	5000.0	5000.0	5000.0	5000.0	5000.0	5000.0	5000.0	5000.0	5000.0	5000.0
	E002	5000.0	5000.0	5000.0	5000.0	5000.0	5000.0	5000.0	5000.0	5000.0	5000.0
Notch 4 Frequency [Hz]	E001	5000.0	5000.0	5000.0	5000.0	5000.0	5000.0	5000.0	5000.0	5000.0	5000.0
	E002	5000.0	5000.0	5000.0	5000.0	5000.0	5000.0	5000.0	5000.0	5000.0	5000.0

At the bottom of the window, there are buttons for 'Back to Portal', '< Back', and 'Next >'.

## Step 4: Checking Operation (Data Trace)

In this step, you can check the auto tuning results by data tracing.

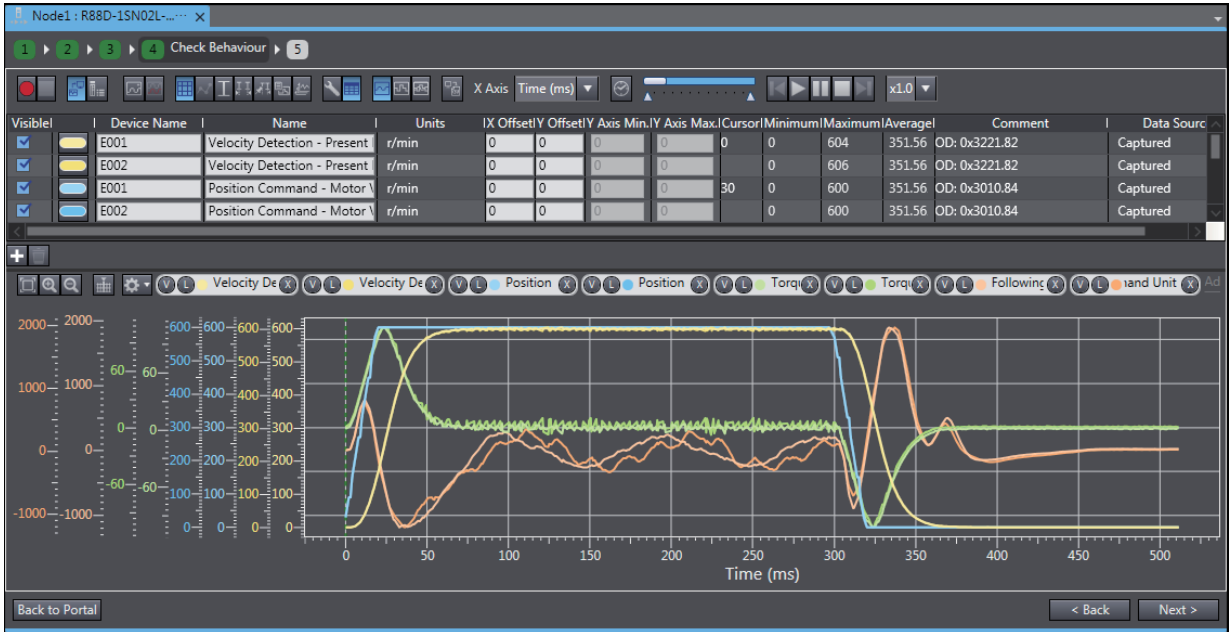

### Additional Information

This step is disabled for an independent Drive connecting via a Programmable Multi-Axis Controller.

## Step 5: Completion

A list of parameter values set as the results of auto tuning is displayed.

OD	Description	Units	E001	E002
3000.03	Basic Functions - Control Method Selection		1: TDF control	1: TDF control
3001.01	Machine - Inertia Ratio	%	1178	1178
3011.03	Position Command Filter - IIR Filter Enable		1: Enabled	1: Enabled
3011.04	Position Command Filter - IIR Filter Cutoff Freq...	Hz	45.7	46.1
3012.01	Damping Control - Damping Filter 1 Selection		0: Disabled	0: Disabled
3012.02	Damping Control - Damping Filter 2 Selection		0: Disabled	0: Disabled
3013.01	Damping Filter 1 - 1st Frequency	Hz	300.0	300.0
3013.02	Damping Filter 1 - 1st Damping Time Coefficient	%	100	100
3013.03	Damping Filter 1 - 2nd Frequency	Hz	300.0	300.0
3013.04	Damping Filter 1 - 2nd Damping Time Coefficient	%	100	100
3013.05	Damping Filter 1 - 3rd Frequency	Hz	300.0	300.0
3013.06	Damping Filter 1 - 3rd Damping Time Coefficient	%	100	100
3013.07	Damping Filter 1 - 4th Frequency	Hz	300.0	300.0
3013.08	Damping Filter 1 - 4th Damping Time Coefficient	%	100	100
3014.01	Damping Filter 2 - 1st Frequency	Hz	300.0	300.0
3014.02	Damping Filter 2 - 1st Damping Time Coefficient	%	100	100



# 4

## Applied Servo Drive Operations

This section describes applied operations of Servo Drives.

4

---

<b>4-1</b>	<b>Manual Tuning</b> .....	<b>4-2</b>
4-1-1	1S Series Advanced Tuning .....	4-2
4-1-2	1S Series Manual Tuning (Single Drive) .....	4-14
4-1-3	1S Series Manual Tuning (Multiple Drives) .....	4-17
4-1-4	G5 Series Manual Tuning .....	4-18
<b>4-2</b>	<b>Other Tuning Functions</b> .....	<b>4-19</b>
4-2-1	FFT .....	4-19
4-2-2	Damping Control .....	4-23
<b>4-3</b>	<b>Motor Settings (only for Linear Motor Type of G5 Series)</b> .....	<b>4-27</b>

## 4-1 Manual Tuning

Two manual tuning methods, advanced tuning and manual tuning, are supported.

### 4-1-1 1S Series Advanced Tuning

Right-click the Drive and select **Setup and Tuning** from the menu.

Then, click the **Advanced Tuning** button.

Adjust the gain and filter settings using the simulator based on FFT measurement data. You can perform fine tuning in a short time without the need to repeat actual motor operations.



#### Precautions for Safe Use

The advanced tuning for 1S Series is made through a simulation of motor operations. The actual operation may be different from the simulated operations. Ensure safety before the actual operation after the tuning.



#### Additional Information

- Simulation results are just a reference for tuning. Please perform the final operation check with actual machines using the data trace, FFT, and other functions.
- The simulation cannot be performed correctly under the following conditions.  
(Use the data trace, FFT, and other functions for tuning.)

<b>Load</b>	When the inertia or friction has not been correctly set or estimated.
	When backlash and other non-linear elements are included in the machine.
<b>Operation pattern</b>	When a large torque in proximity to the torque limit occurs.

The tuning consists of the following steps.

Button	Step
Advanced Tuning	1. Configuration
	2. Frequency Response Simulation
	3. Time Response Simulation
	4. Check Behavior
	5. Results

## Step 1: Configuration

Confirm the control method and select the control mode (*Position Control* or *Speed Control*).

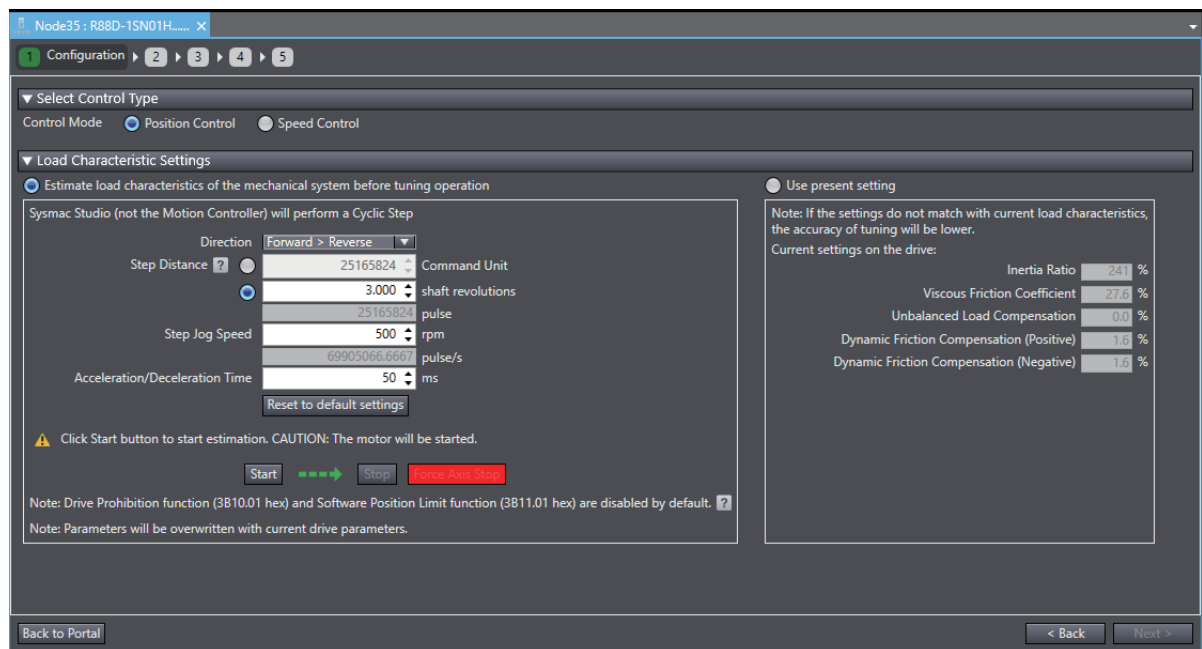

### ● Step 1-1: Selecting the Control Mode

Select *Position Control* or *Speed Control*.

### ● Step 1-2: Setting the Load Characteristics

To simulate the motor operation correctly, you need to set the load characteristics according to the device.

If you select the *Estimate load characteristics of the mechanical system before tuning operation* option, the motor will run to automatically estimate the load characteristics such as inertia ratio and viscous friction coefficient. Set the operation conditions and click the **Start** button to run the motor.

Select the *Use present setting* option:

- if you have already set the inertia ratio and viscous friction coefficient correctly
- if you are going to simulate frequency characteristics based on an imported drvfft file

When the settings are completed, click the **Next** button.

## Step 2: Frequency Response Simulation

Perform the frequency response simulation for tuning.

If you set the gain parameters manually after executing FFT, the frequency response characteristics of the control results will be changed according to the parameter settings through a simulation. The gain parameters can be adjusted to the optimum values by this operation.

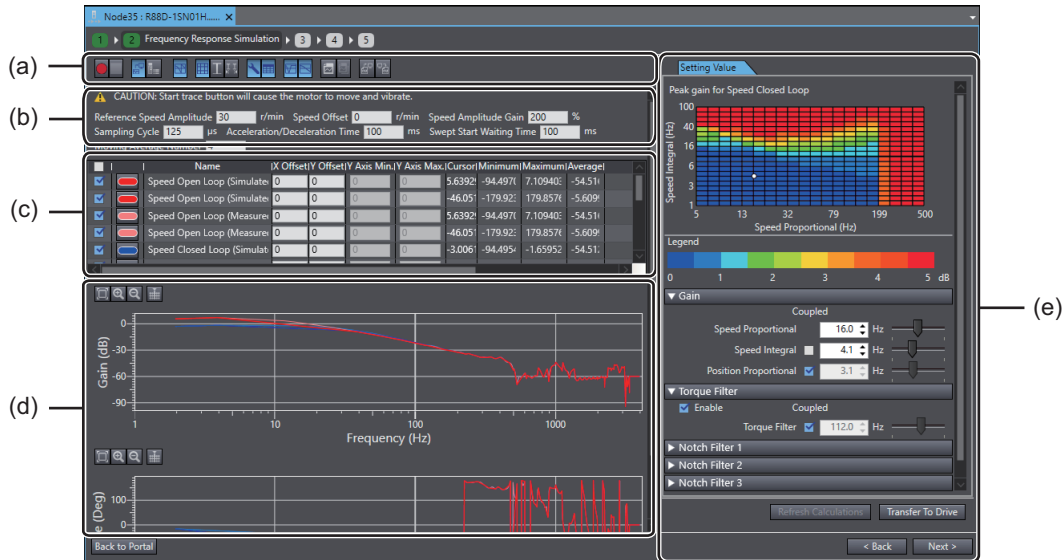

No.	Item	Description
(a)	Toolbar	The buttons to start/stop FFT, import/export and display various items are displayed.
(b)	FFT measurement condition area	Set the FFT measurement conditions.
(c)	Frequency characteristics data area	Select the frequency characteristics data to display.
(d)	Analysis result graph area	The analysis result graphs of frequency response waveforms are displayed.
(e)	Setting Value tab page	Adjust the setting values (gain parameters) displayed here while checking the frequency response waveforms.

## ● Step 2-1: Execute Simulation

There are two methods to execute the simulation:

- Perform FFT operation

- (1) Setting the FFT Measurement Conditions.

Set the conditions in the FFT measurement condition area (b). Refer to *4-2-1 FFT* on page 4-19 for details.

- (2) Starting the FFT.

Click the Start button () on the Toolbar (a). The frequency characteristics will be measured.



### Precautions for Correct Use

---

The motor will run. Be careful to ensure safety.

---

- Import FFT

Click the Import button () on the Toolbar (a). Select the Drive FFT (\*.drvfft) file and the frequency characteristics will be loaded.

## ● Step 2-2: Checking the Frequency Response Waveforms and Values of the Analysis Results

After the measurement, the measured frequency response waveforms are displayed in the analysis result graph area (d). Also, the values are displayed in the frequency characteristics data area (c).

● **Step 2-3: Changing the Setting Values (Gain Parameters)**

There are two methods to change the setting values in the Setting Value tab page (e).

- (1) Select the peak gain by clicking the Maps chart

In the chart, the horizontal axis represents the speed proportional gain and the vertical axis represents the speed integral gain. The peak gain of the speed loop is expressed by color. As the color changes from blue to red, the peak gain is increased and the control becomes unstable. To suppress the peak gain, set the speed gain in the blue area. The peak gain is suppressed by setting the notch filter and the torque command filter properly, which increases the blue area.

- (2) Adjust each setting value individually

Item		Description	
Setting Value	Gain	Speed Proportional	Set the 1st speed proportional gain.
		Speed Integral	Set the 1st speed integral gain.
		Position Proportional	Set the 1st position proportional gain.
	Torque Filter	Enable	Select this check box to enable the torque filter.
		Torque Filter	Set the cutoff frequency for the 1st torque command filter.
	Notch Filter 1/2/3/4	Enable	Select this check box to enable resonance suppression notch filter.
		Frequency	Set the notch frequency of the resonance suppression notch filter.
		Q value	Set the Q-value of the resonance suppression notch filter.
		Depth	Set the notch depth of the resonance suppression notch filter.

For the items with a *Coupled* check box, their values can be automatically changed according to the value of the 1st speed proportional gain. When you want to automatically set the values according to the 1st speed proportional gain setting, select the check boxes. If you want to set each value individually, clear the selection.

After changing each setting value by the methods 1 or 2, click the **Refresh Calculations** button to update the simulation results of the frequency response waveforms. While checking the frequency response waveforms, set the optimum gains.

When you want to perform the FFT again using the updated settings, perform Step 2 after clicking the **Transfer To Drive** button.

When the settings are completed, click the **Next** button.

● **Toolbar**



The Toolbar provides the buttons to start/stop FFT, display various items, and perform other operations. Refer to 4-2-1 FFT on page 4-19 for details.

### Step 3: Time Response Simulation

Perform the time response simulation for tuning.

The delay, overshoot, and other control results to the operation commands (i.e., motion profiles of acceleration/deceleration type) are simulated.

When you set an operation pattern that you want to simulate in the **Motion Profile** area and click the **Simulate Motion Profile** button, the response waveforms of the simulation results will be displayed.

While checking the displayed waveforms, adjust the values of the parameters. Select the waveform that you want to refer to from the variable table according to your tuning purpose.

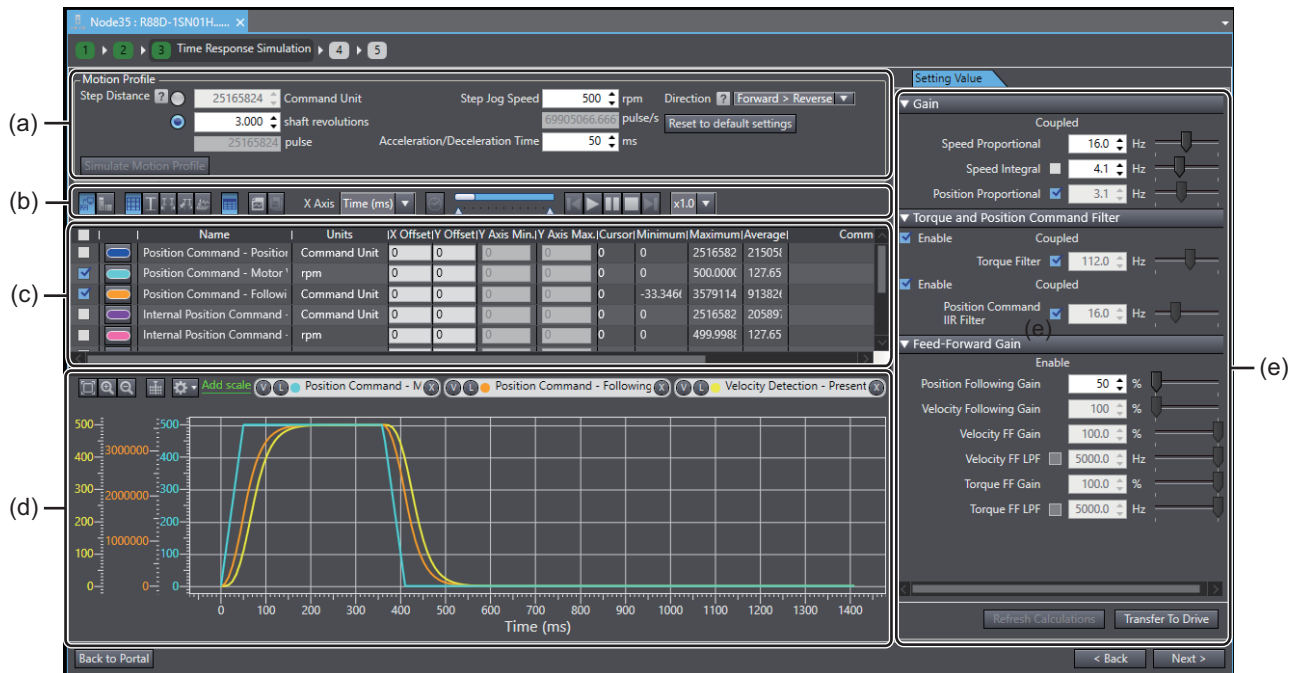

No.	Item	Description
(a)	Operation command area	Set the operation command conditions.
(b)	Toolbar	Buttons to display various items are displayed.
(c)	Time response value display area	Select the items to check in the time response.
(d)	Time response result graph area	Time response waveforms calculated by the simulation for the selected data are displayed.
(e)	Setting Value tab page	Adjust the setting values (gain parameters) displayed here while checking the time response waveforms.

### ● Step 3-1: Setting the Operation Commands

Set the following to specify the operation pattern to simulate in the operation command area (a):

- Step distance, step jog speed, acceleration/deceleration time and direction.



#### Additional Information

---

Selected direction will be used in *Step 4: Check Behavior* on page 4-10.

In *Step 3: Time Response Simulation* on page 4-7, direction is fixed to **Forward Only**.

---

After setting the values, click the **Simulate Motion Profile** button. The operation pattern that you set and the response are simulated.

### ● Step 3-2: Selecting the Items to Check in the Time Response

Select the items to check in the time response value display area (c).

- Clear the selection of the *Visible* check boxes on the extreme left of the items that are not to be displayed in the graph area.
- Click  to the right of the *Visible* check box and specify a color to be used in the graph area.

### ● Step 3-3: Checking the Time Response Waveforms and Values of the Time Response Results

After the simulation, the time response waveforms for the items selected in Step 3-2 are displayed in the time response result graph area (d).



### ● Step 3-4: Changing the Setting Values (Gain Parameters)

Adjust each setting value in the Setting Value tab page (e).

Item		Description	
Setting Value	Gain	Speed Proportional	Set the 1st speed proportional gain.
		Speed Integral	Set the 1st speed integral gain.
		Position Proportional	Set the 1st position proportional gain.
	Torque and Position Command Filter	Enable	Select this check box to enable the torque filter.
		Torque Filter	Set the cutoff frequency for the 1st torque command filter.
		Position Command IIR Filter	Set the IIR filter cutoff frequency for the position command filter.
	Feed-forward Gain	Enable	Select this check box to enable each filter.
		Position Following Gain	Set the command following gain for the TDF position control. This can be set only for the TDF control.
		Velocity Following Gain	Set the command following gain for the TDF velocity control. This can be set only for the TDF control.
		Velocity FF Gain	Set the gain for velocity feed-forward.
		Velocity FF LPF	Set the LPF cutoff frequency for the ODF velocity feed-forward. This can be set only for the ODF control.
		Torque FF Gain	Set the gain for torque feed-forward.
		Torque FF LPF	Set the LPF cutoff frequency for the ODF torque feed-forward. This can be set only for the ODF control.

For the items with a Coupled check box, their values can be automatically changed according to the value of the 1st speed proportional gain. When you want to automatically set the values according to the 1st speed proportional gain setting, select the check boxes. Clear the selection if you want to set each value individually.

### ● Step 3-5: Applying the Gain Parameters to the Waveforms

To apply the updated settings to the simulation results, click the **Refresh Calculations** button.

When the settings are completed, click the **Next** button.

### ● Toolbar



The buttons to display trace target variables, export, and perform other operations are provided. Refer to 3-6 *Data Tracing* on page 3-24 for details.

## Step 4: Check Behavior

In this step, you can check the results by data tracing.

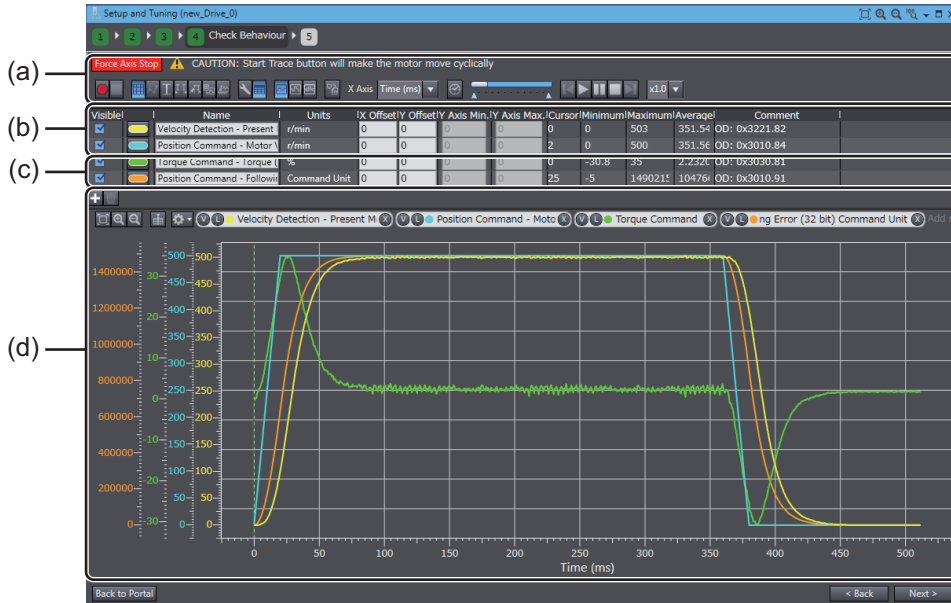

No.	Item	Description
(a)	Toolbar	Buttons to start and stop tracing and display various items are displayed.
(b)	Trace setting area	Set the sampling start conditions.
(c)	Trace target area	Specify the sampling target data.
(d)	Graph area	Trace graphs of sampled data are displayed.

### ● Step 4-1: Setting the Trace Conditions and Trace Target

Refer to 3-6 *Data Tracing* on page 3-24 for details.

### ● Step 4-2: Starting a Trace

Click the **Start Trace** button in the Toolbar (a).



#### Precautions for Correct Use

When you selected the *Sysmac Studio (not the Motion Controller)* will perform a *Cyclic Step* option in the **Motion Profile Generator** setting, be careful because the motor will start running by clicking the **Start** button.

### ● Step 4-3: Checking the Graphs

The traced data are displayed in the graph area (d).

## Step 5: Results

A list of parameter values adjusted by the speed frequency response simulation and time response simulation are displayed.

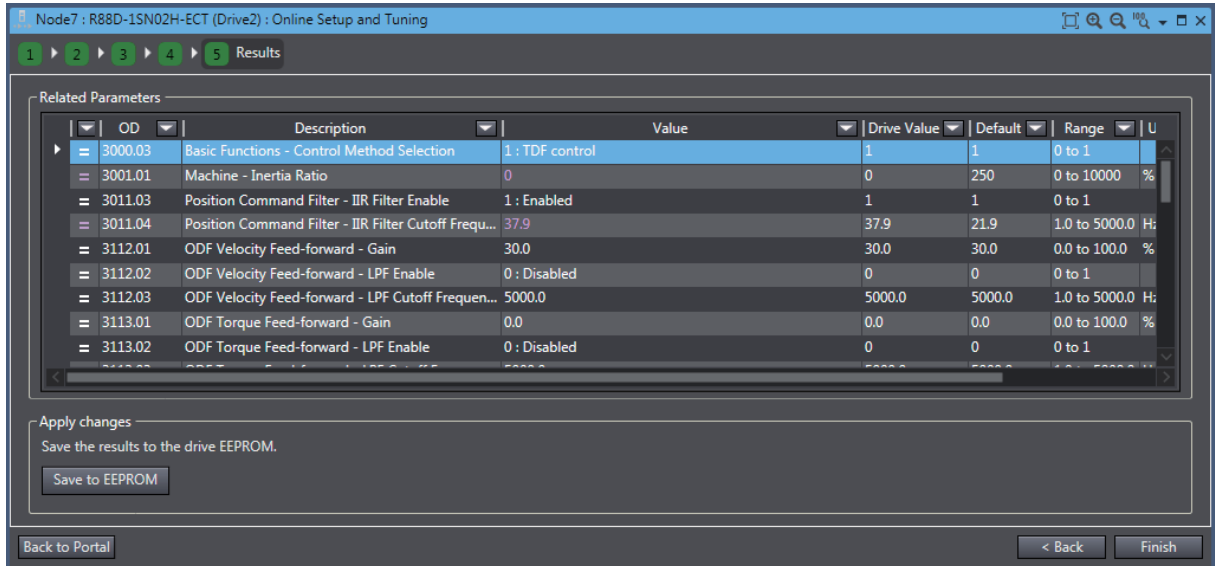

- **Step 5-1: Checking the Related Parameters**

Check the related parameters as the result of tuning.

- **Step 5-2: Transferring the Parameter Results after the Tuning to the Drive**

Click the **Save to EEPROM** button. The related parameters above are transferred to the non-volatile memory of the Drive.

When the settings are completed, click the **Finish** button. The portal page of the Setup and Tuning wizard will be displayed.

## Objects Set by the Tuning

---

The following objects are set by the advanced tuning. Refer to the *1S-series AC Servomotors and Servo Drives User's Manual (with Built-in EtherCAT® Communications)* (Cat. No. I586) for details of each object.

### ● List of Objects Set to a Fixed Value

Index (Hex)	Sub index (Hex)	Name	Unit	Setting value
3320	---	Adaptive Notch Filter	---	---
	01	Adaptive Notch Selection	---	0

● List of Objects Set According to the Settings in Steps 2 and 3

Index (Hex)	Sub index (Hex)	Name
3011	---	Position Command Filter
	03	IIR Filter Enable
	04	IIR Filter Cutoff Frequency
3112	---	ODF Velocity Feed-forward
	01	Gain
	02	LPF Enable
	03	LPF Cutoff Frequency
3113	---	ODF Torque Feed-forward
	01	Gain
	02	LPF Enable
	03	LPF Cutoff Frequency
3120	---	TDF Position Control
	01	Command Following Gain
	10	Command Following Gain Selection* <sup>1</sup>
	11	Command Following Gain 2* <sup>1</sup>
3121	---	TDF Velocity Control
	01	Command Following Gain
3122	---	TDF Velocity Feed-forward
	01	Gain
3123	---	TDF Torque Feed-forward
	01	Gain
3213	---	1st Position Control Gain
	01	Proportional Gain
3223	---	1st Velocity Control Gain
	01	Proportional Gain
	02	Integral Gain
3233	---	1st Torque Command Filter
	01	Enable
	02	Cutoff Frequency
3321	---	1st Notch Filter
	01	Enable
	02	Frequency
	03	Q-value
	04	Depth
3322	---	2nd Notch Filter
	01	Enable
	02	Frequency
	03	Q-value
	04	Depth
3323	---	3rd Notch Filter
	01	Enable
	02	Frequency
	03	Q-value
	04	Depth
3324	---	4th Notch Filter
	01	Enable
	02	Frequency
	03	Q-value
	04	Depth

\*1. Revised in Servo Drive Unit Version 1.1 or later.

## 4-1-2 1S Series Manual Tuning (Single Drive)

Right-click the Drive and select **Setup and Tuning** from the menu.

Then, click the **Manual Tuning** button.

Object values of related gain parameters can be adjusted at the same time by manually adjusting the setting value of machine rigidity.

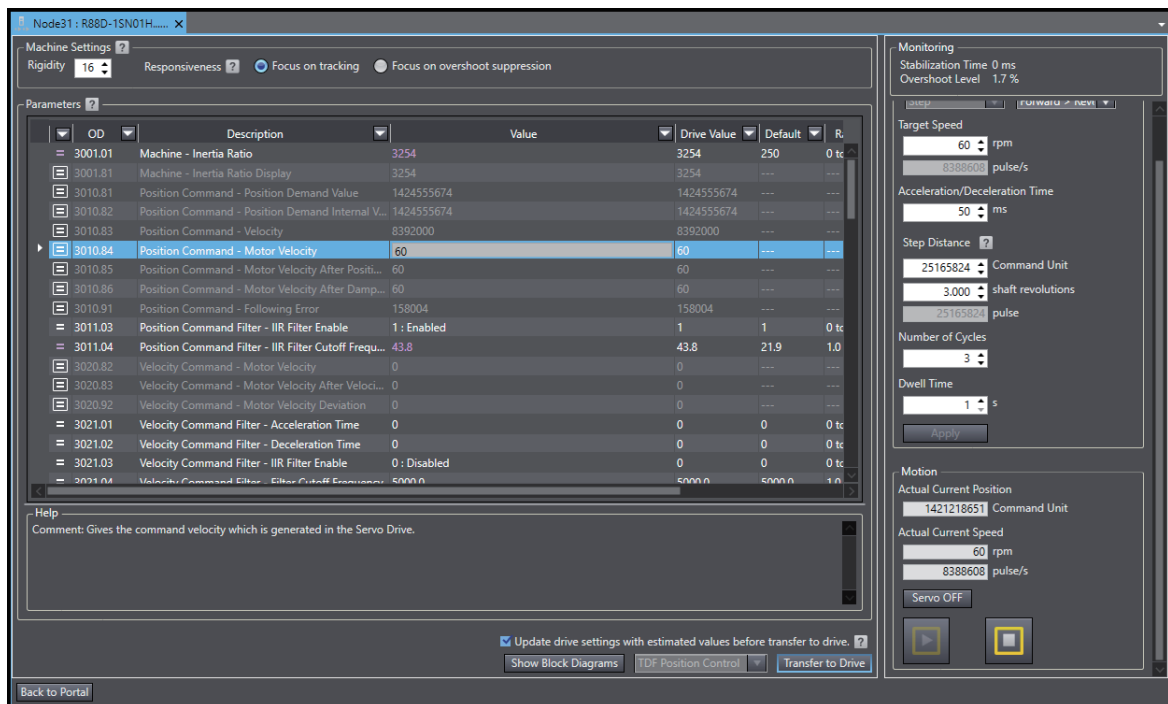

### ● Step 1: Setting the Machine Rigidity and Responsiveness

Set the machine rigidity within the following value range.

0 to 31

According to the machine rigidity setting value, parameters listed in step 3 are set at the same time.

### ● Step 2: Setting the Machine Responsiveness

When the control method is set to Two-degree-of-freedom, select the Responsiveness.

Option	Description
Focus on tracking	Priority is given to response of the positioning operation in the tuning. Overshoot may occur depending on the machine and/or tuning conditions.
Focus on overshoot suppression	Priority is given to overshoot suppression in the tuning.

### ● Step 3: Adjusting the Machine Rigidity Settings

Adjust the machine rigidity setting value to achieve the target performance while checking the motor operation using the data trace function, FFT function, and external measuring instruments.

Rigid- ity	1st Gain/2nd Gain					Position Command Filter	
	Position Control Gain	Speed Control Gain		Torque Command Filter		Position Command Filter	
	3213 hex/3214 hex	3223 hex/3224 hex		3233 hex/3234 hex		3011 hex	
	Proportional Gain	Proportional Gain	Integral Gain	Enable	Cutoff Frequency	IIR Filter Enable	IIR Filter Cut-off Frequency
	01 hex [0.1 Hz]	01 hex [0.1 Hz]	02 hex [0.1 Hz]	01 hex [-]	02 hex [0.1 Hz]	03 hex [-]	04 hex [0.1 Hz]
0	2	11	3	1	77	1	11
1	3	14	4	1	97	1	14
2	3	17	5	1	122	1	17
3	4	22	6	1	154	1	22
4	5	28	7	1	193	1	28
5	7	35	9	1	243	1	35
6	8	44	12	1	307	1	44
7	10	55	15	1	386	1	55
8	13	69	19	1	486	1	69
9	16	87	23	1	612	1	87
10	21	110	29	1	770	1	110
11	27	138	36	1	969	1	138
12	35	174	45	1	1220	1	174
13	44	219	55	1	1536	1	219
14	57	276	69	1	1934	1	276
15	73	348	85	1	2435	1	348
16	94	438	105	1	3065	1	438
17	120	551	130	1	3859	1	551
18	154	694	162	1	4858	1	694
19	197	874	200	1	6116	1	874
20	250	1100	250	1	7700	1	1100
21	315	1385	315	1	9694	1	1385
22	396	1743	396	1	12204	1	1743
23	445	1956	445	1	13693	1	1956
24	499	2195	499	1	15364	1	2195
25	560	2463	560	1	17238	1	2463
26	628	2763	628	1	19342	1	2763
27	705	3100	705	1	21702	1	3100
28	791	3479	791	1	24350	1	3479
29	887	3903	887	1	27321	1	3903
30	995	4379	995	1	30654	1	4379
31	1117	4914	1117	1	34395	1	4914

Note Setting the position command filter by manual tuning is valid only for the two-degree-of-freedom control. In the one-degree-of-freedom control, the position command filter settings are not changed by manual tuning.



#### Additional Information

If vibration is caused by setting high machine rigidity, suppress the resonance by using the adaptive notch filters. Refer to the *1S-series AC Servomotors and Servo Drives User's Manual (with Built-in EtherCAT® Communications)* (Cat. No. I586) for details of the adaptive notch filters.

● **Step 4: Adjusting Parameters Manually**

Use either the parameter grid view or block diagrams view to adjust tuning parameters manually. Click buttons **Show Block Diagrams** and **Show Parameter Grid** to switch between views.

When Block Diagrams view is selected, the available diagrams depend on control method.

Control method	Available diagrams
Two-degree-of-freedom	TDF Position Control TDF Velocity Control Torque Control
One-degree-of-freedom	ODF Position Control ODF Velocity Control Torque Control

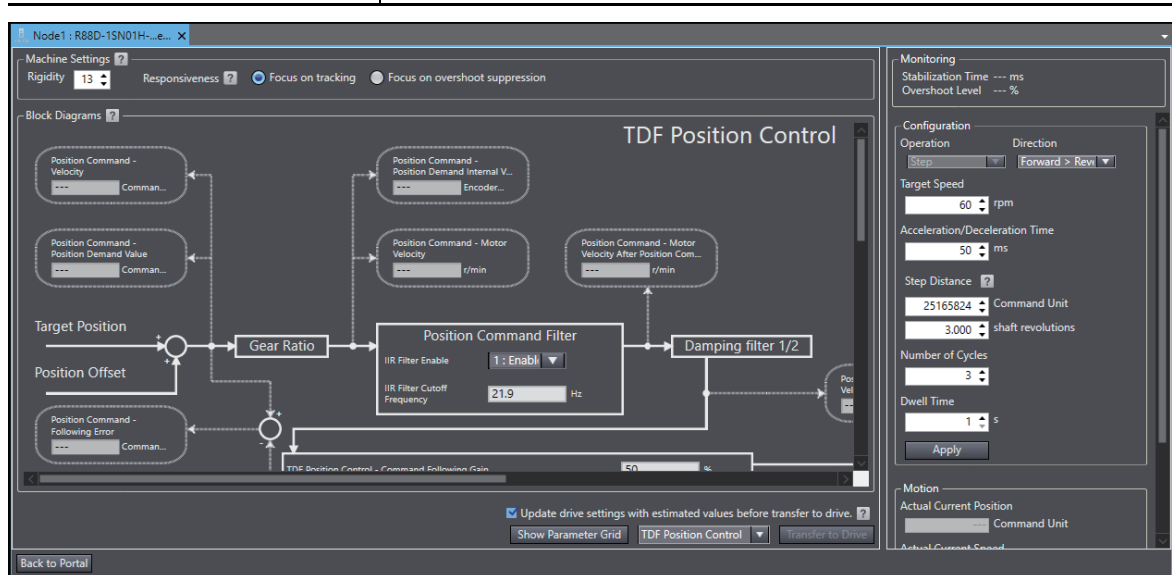

Monitoring objects can be traced with data tracing function. Right-click any monitoring object and select command **Copy Parameter Name** from the context menu. Then, paste it on trace target area of data tracing function.

● **Step 5: Check Behavior**

Check the tuning results monitoring **Stabilization Time** and **Overshoot Level** displayed in Test Run area.

● **Step 6: Transferring the Parameter Results after the Tuning to the Drive**

Click the **Transfer to Drive** button. The related parameters above are transferred to the non-volatile memory of the Drive.

Select the checkbox **Update drive settings with estimated values before transfer to drive** if you want to update project data and drive settings for inertia ratio and notch filters with estimated values. The update occurs before transfer operation.

When the settings are completed, click the **Back to Portal** button. The portal page of the Setup and Tuning wizard will be displayed.



### 4-1-3 1S Series Manual Tuning (Multiple Drives)

Right-click the Drive and select **Setup and Tuning** from the menu. Then, click the **Manual Tuning** button in Tuning (Multiple Drives).

You can perform Manual tuning on multiple compatible Drives at the same time.

Except for the functionality described later, the settings, operation, and tunable parameters are the same as those for single-drive tuning. Refer to 4-1-2 *1S Series Manual Tuning (Single Drive)* on page 4-14 for detail.

- **Start Setting**

Select drives to be tuned simultaneously.

- **Applying Parameters to Other Drives**

You can automatically apply the results of tuning performed on the Drive from which you started the **Setup and Tuning** to other Drives. Select the **Coupled** check boxes for the Drives you want to apply the results to.

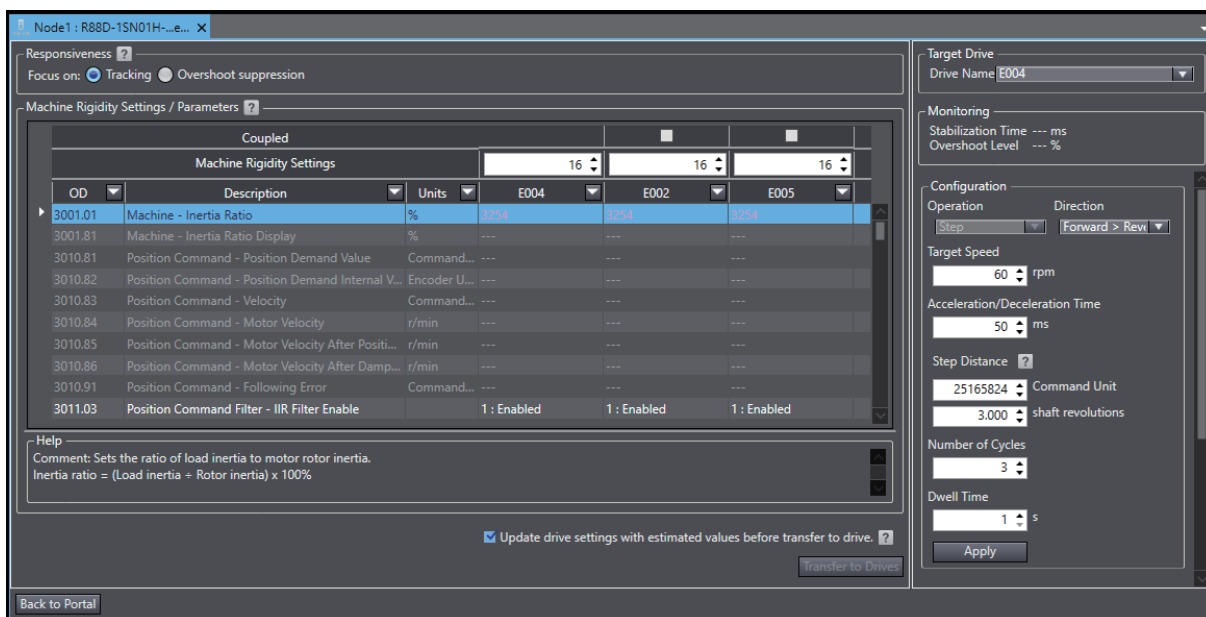

## 4-1-4 G5 Series Manual Tuning

Right-click the tuning-target Drive and select **Auto Tuning** from the menu.

A wizard is started for tuning the G5-series Drive. Click the **Manual Tuning** button.

Values of related gain parameters can be adjusted at the same time by manually adjusting the setting value of machine rigidity.

Index	OD	Description	Value	Drive
Pn100	3100.00	Position Loop Gain 1	48.0	---
Pn101	3101.00	Speed Loop Gain 1	27.0	---
Pn102	3102.00	Speed Loop Integration Time Constant 1	21.0	---
Pn103	3103.00	Speed Feedback Filter Time Constant 1	0	---
Pn104	3104.00	Torque Command Filter Time Constant 1	0.84	---
Pn105	3105.00	Position Loop Gain 2	57.0	---
Pn106	3106.00	Speed Loop Gain 2	27.0	---
Pn107	3107.00	Speed Loop Integral Time Constant 2	1000.0	---
Pn108	3108.00	Speed Feedback Filter Time Constant 2	0	---
Pn109	3109.00	Torque Command Filter Time Constant 2	0.84	---



### Additional Information

To perform Manual tuning, set the value for parameter Pn002 (OD 3002.00h) to 0.

The value for parameter Pn003 (OD 3003.00h) is used for rigidity.

## 4-2 Other Tuning Functions

### 4-2-1 FFT

Open the FFT tab page by double-clicking **FFT** in the Multiview Explorer.

Frequency characteristics (gain characteristics and phase characteristics) of the machine are measured by FFT (Fast Fourier Transform) using the actual speed to the command speed.

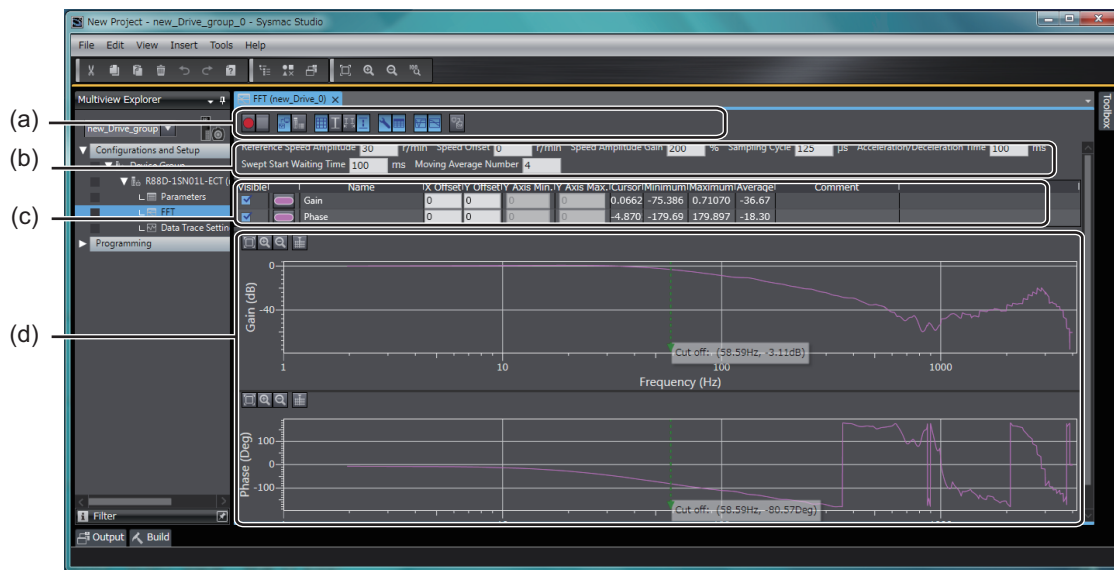

## CAUTION

If you perform FFT analysis, the motor velocity may change drastically. Be particularly careful to ensure safety. Provide a means so that you can at any time turn OFF the Servo power supply in an emergency.

Do not use FFT analysis if a wide range of motor operation presents a risk of machine failure.

Keep the gain as low as possible when you make measurements.



No.	Item	Description
(a)	Toolbar	Buttons to start/stop a trace and display various items are displayed.
(b)	FFT measurement condition area	Set the FFT measurement conditions.
(c)	Frequency characteristics value display area	Select the frequency characteristics to display.
(d)	FFT analysis result graph area	The FFT analysis result graphs are displayed.

### ● Step 1: Setting the FFT Measurement Conditions

Set the conditions in the FFT measurement condition area (b).

Drive series	Item	Description
1S Series	Reference Speed Amplitude	Set the amplitude of command velocity of motor operation. The noise influence on the FFT results is reduced by setting a larger value, but the motor's movement becomes bigger. Try from a small value so as not to exceed the operation range of the machine.
	Speed Offset	Set the speed offset to the command velocity of motor operation. If the static friction is large, the noise influence can be reduced by setting a larger value. However, try from a small value so as not to exceed the operation range of the machine because the machine moves in one direction when the speed offset is set.
	Speed Amplitude Gain	Set the amplitude gain to the reference speed amplitude at the end of motor operation. The noise influence in the high frequency zone can be reduced by setting a value over 100%. However, try from a small value because the motor movement range becomes larger as you set a larger value.
	Sampling Cycle	Set the sampling cycle of the I/O waveform. The shorter the sampling cycle is, the larger the upper/lower limit values of the measurable frequency are.
	Acceleration/Deceleration Time	Set the acceleration/deceleration time of motor operation. If a large speed offset is set, the acceleration rate becomes large, which may have impact on the machine. The acceleration rate can be reduced by making the acceleration time longer.
	Swept Start Waiting Time	Set the time until the command velocity is input after completion of acceleration to the speed offset. Set the time in which the actual speed can be settled to the speed offset.
	Moving Average Number	Set the number of moving average points applied when the graph of measurement results is displayed. The graph becomes smooth by setting a large value. Set this value before running the FFT, changes made to the value after an FFT is run are not applied to the graph.
G5 Series	Input Half Amplitude	Set the amplitude of command velocity of motor operation. The noise influence on the FFT results is reduced by setting a larger value, but the motor's movement becomes bigger. Try from a small value so as not to exceed the operation range of the machine.
	Input Offset	Set the speed offset to the command velocity of motor operation. If the static friction is large, the noise influence can be reduced by setting a larger value. However, try from a small value so as not to exceed the operation range of the machine because the machine moves in one direction when the speed offset is set.
	Sampling Rate	Set the sampling cycle of the I/O waveform. The shorter the sampling cycle is, the larger the upper/lower limit values of the measurable frequency are.
	Moving Average Number	Set the number of moving average points applied when the graph of measurement results is displayed. The graph becomes smooth by setting a large value. Set this value before running the FFT, changes made to the value after an FFT is run are not applied to the graph.

## ● Step 2: Starting the Data Trace

Click the  button on the Toolbar (a). The frequency characteristics are measured.



### Precautions for Correct Use

The motor will run. Be careful to ensure safety.















## ● Step 3: Checking the Frequency Response Waveforms and Values in the Frequency Characteristics Display Area



After the measurement, the traced frequency response waveforms of the specified data are displayed in the analysis result graph area (d). Also, the values are displayed in the frequency characteristics value display area (c).

When the settings are completed, click the **Next** button.

## ● Toolbar



	Start	Starts the FFT measurement.
	Stop	Stops the FFT operation.
	Transfer Parameters from Drive After Trace	Uploads the parameters from the Drive after the FFT measurement.
	Open Properties	Displays the Properties pane.
	Save as History	Saves the displayed graph data as history.
	Show History	Displays the graph data saved as history.
	Limit the Phase to be between -180 and 180 degrees	Displays the Phase in such a way that it turns at -180 and 180 degrees each.
	Switch Layout	Changes the display position of the trace target table to above or to the left of the graphs.
	Show Grid	Displays the grid in the graph area.
	Show Cursor	Displays a cursor to check the values of each variable at the specified X axis value on the graph.
	Show Range Cursors	Displays the cursors to check the difference between the specified two points. This is useful for displaying such information as the time between when a certain value changed to TRUE and when it changed to TRUE again.
	Show Cutoff Cursor	Displays a cursor to see the cutoff frequency/.
	Show Configuration	Displays the FFT measurement targets.
	Show Data Table	Displays the frequency characteristics data table.

	Show Gain Chart	Displays a gain chart in the graph area.
	Show Phase Chart	Displays a phase chart in the graph area.
	Export	Exports the FFT settings, FFT measurement results, and drive parameter settings at the time of measurement to a CSV file or Drive FFT file.

● **FFT Parameters:**

Column title	Description	Type
<b>Visible</b>	Select or clear the check box to show/hide the item.	Check box
---	The graph color is displayed. You can change the color.	Color selection
<b>Name</b>	The FFT measurement target's name, <i>Gain</i> or <i>Phase</i> is displayed.	Read only
<b>X Offset</b>	Set the offset of the X axis.	Editable
<b>Y Offset</b>	Set the offset of the Y axis.	Editable
<b>Y Axis Min.</b>	The minimum value of the range of Y axis for the FFT measurement target is displayed.	Read only
<b>Y Axis Max.</b>	The maximum value of the range of Y axis for the FFT measurement target is displayed.	Read only
<b>Cursor</b>	The value at the cursor is displayed.	Read only
<b>Minimum</b>	The minimum value of the plotted data for the FFT measurement target is displayed.	Read only
<b>Maximum</b>	The maximum value of the plotted data for the FFT measurement target is displayed.	Read only
<b>Average</b>	The average value of the plotted data for the FFT measurement target is displayed.	Read only

## 4-2-2 Damping Control

Right-click the Drive and select **Damping Control** from the menu.

With the damping control function of Sysmac Studio, you can easily make the damping control setting based on the automatically detected vibration frequency.

When you select **Damping Control**, the following caution dialog box is displayed.

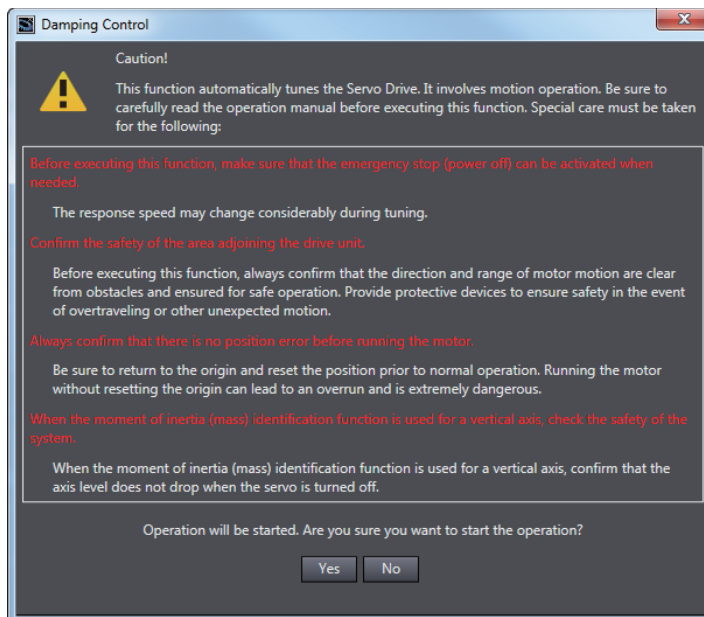

Ensure safety for starting the operation. Then, click the **Yes** button.



### Precautions for Safe Use

Damping control is automatically performed by the Servo Drive. The motor operates during the adjustment. Follow the following safety precautions.

- Provide a means to perform an emergency stop (i.e., to turn OFF the power supply). The response may greatly change during the adjustment.
- Confirm safety around all moving parts. Always confirm that there are no obstacles in the movement range and directions of the motor and that the motor can operate safely. Provide protective measures for unexpected motion.
- Before you start the adjustment, make sure that the device that is being adjusted is not out of place. Before you start normal operation, make sure to perform homing to reset the position. If home is not reset before the adjustment is performed, the motor may run away, creating a very hazardous condition. Confirm the safety of the system if you use a vertical axis. Make sure that the object that is being adjusted does not fall when the Servo is turned OFF.



### Precautions for Correct Use

- If the vibration is small, it may not be detected. In that case, increase the shock at the time of stopping within the range the machine is not damaged, for example, by shortening the deceleration time in order to increase the vibration.
- The detected frequency is cleared when the next operation command is input. Do not send consecutive operation commands.

Set the operation command generator and conditions and also damping control conditions.

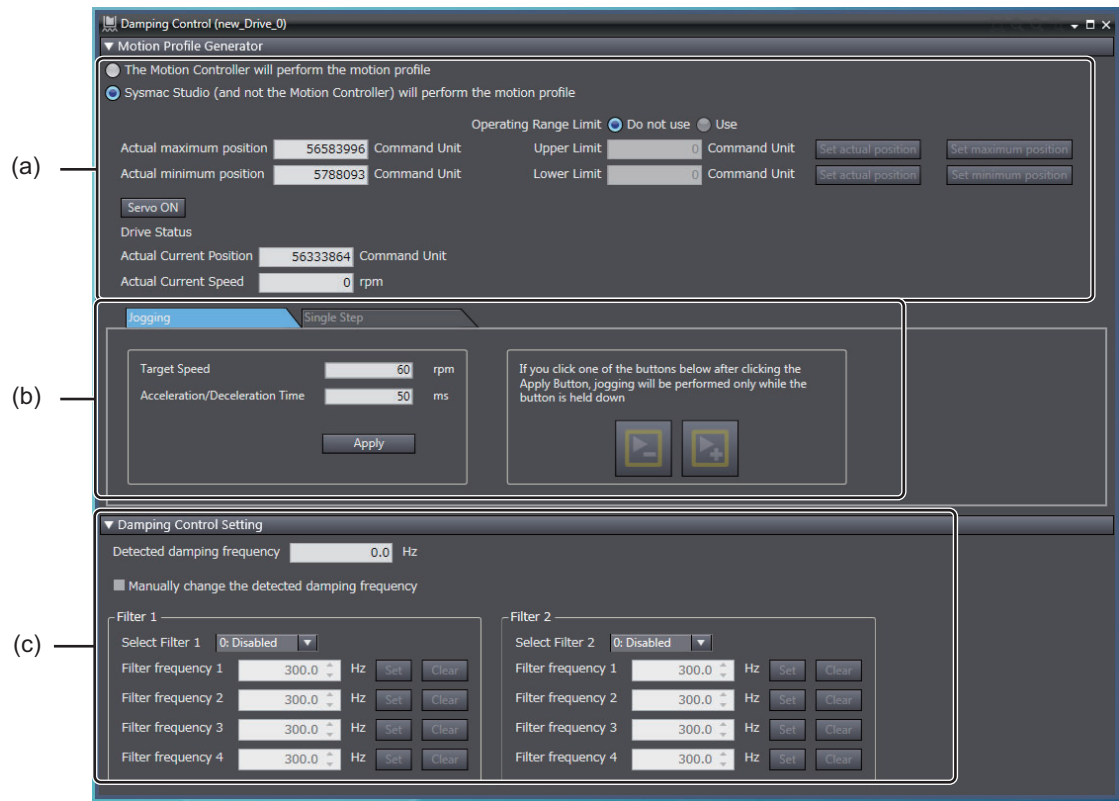

No.	Item	Description
(a)	Command generator	Select the generator of the commands.
(b)	Operation	Execute the operation.
(c)	Damping control settings	Check the detected vibration frequency. Set the detected vibration frequency as the frequency of the damping filter.

### ● Selecting the Generator of the Commands

To measure the vibration of the machine, you need to actually run the motor.

Select whether the Motion Controller or Sysmac Studio should send the commands to run the motor.

Set the following conditions for the operation command (motion profile of acceleration/deceleration type).

Step distance, command speed, and acceleration/deceleration time

### ● Turning ON the Servo Drive

When the commands are sent from Sysmac Studio, click the **Servo ON** button to set the Servo Drive to ON status.







## ● Executing the Operation

Select either of the following operation types.

- Jogging: Executes a specified speed command.
- Single Step: Executes the positioning with trapezoidal acceleration/deceleration once.

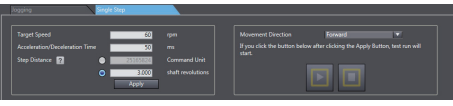
Select either of the operation tabs and make the settings. Then, click the Forward, Reverse, and other buttons to execute the operation.

Tab	Operation type	View	Settings	Operation
Jogging	Jogging		<ul style="list-style-type: none"> <li>• Target Speed</li> <li>• Acceleration/Deceleration Time</li> </ul>	Jogging will be performed while the Forward  (CW) button or the Reverse  (CCW) button is held down.
Single Step	Single Step		<ul style="list-style-type: none"> <li>• Target Speed</li> <li>• Acceleration/Deceleration Time</li> <li>• Step Distance</li> <li>• Movement Direction (Forward or Reverse)</li> </ul>	When the  button is clicked, the test run operation will be started.

## ● Checking the Detected Damping Frequency

The detected damping frequency is displayed in the **Damping Control Setting** area.

## ● Setting the Frequency for Damping Filters

When you set the currently detected damping frequency as the filter frequency of a filter, select the filter to which you want to apply the frequency and click the **Set** button. The detected damping frequency value is automatically set for the selected filter.

To clear the damping frequency that you set, click the **Clear** button.

When you don't want to apply the detected damping frequency as is, but want to manually adjust it, select the *Manually change the detected damping frequency* check box.

The settings become effective immediately. After the setting, operate the machine again and confirm that the vibration is suppressed.

To initialize a setting value, click the **Clear** button.



### Precautions for Correct Use

Depending on the machine type and use conditions, damping frequency may not be detected correctly. In that case, use a measurement instrument to measure the damping control.



### Additional Information

The damping frequency may vary by the movement direction, forward or reverse. In that case, change the value of *Damping Filter Selection* and set the detected damping frequency for each of forward and reverse movement.

- **Stopping the Motor**

Click the **Stop** button to stop the motor.

- **Checking the Drive Status**

Check the actual current position and actual current speed displayed in the **Drive Status** of the **Motion Profile Generator** area.

## 4-3 Motor Settings (only for Linear Motor Type of G5 Series)

Right-click the Drive and select **Motor Setup** from the menu.

Set the parameters for the linear motor type of G5 Series.

You can easily make the motor and external scale settings according to the wizard.

With this function, the following settings can be made automatically.

- External scale settings
- Motor-specific parameters
- Current loop gain

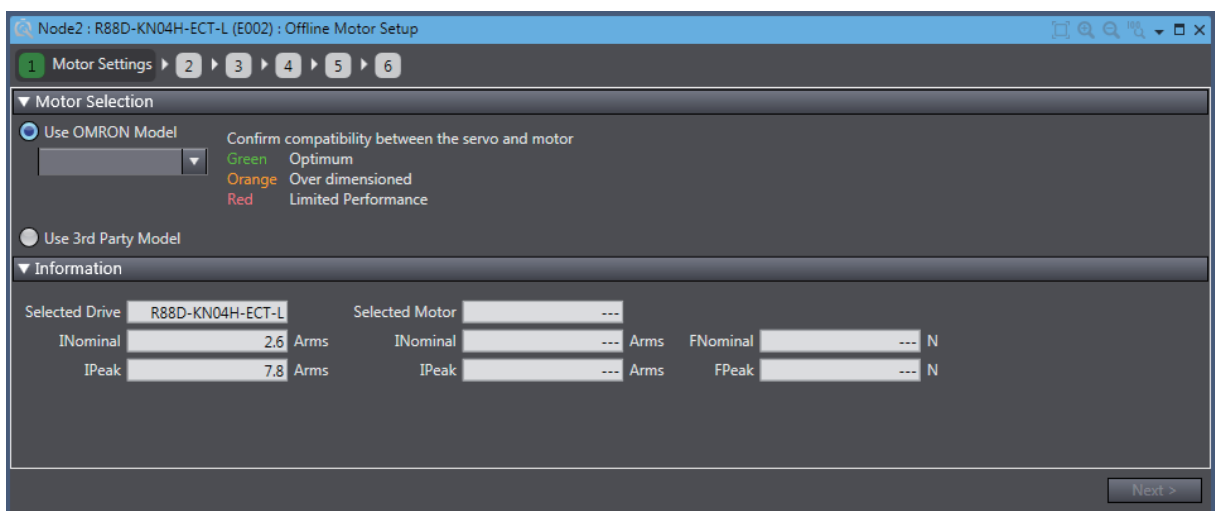

### ● Step 1: Motor Settings

Select the *Use OMRON Model* option. Then, select the motor's model number from the options and click the **Next** button.

### ● Step 2: External Scale Settings

- Select the type of external encoder and enter its resolution.  
Refer to the operation manual of the external encoder for details.
- Select the direction of the external encoder.  
If you execute the Motor System Auto Setup, you don't have to set the direction of external encoder.  
Its direction will be automatically set in Step 6.

Make the external encoder settings and click the **Next** button.

### ● Step 3: Magnetic Pole Settings

Select the 2: *Magnetic Pole position estimated by the drive* option for the magnetic pole detection method.

When you use an absolute value type of external scale, select the option for the first time.

After completion of the magnetic pole position estimation operation, select the magnetic pole position restoration. Then, the magnetic pole position estimation operation is not required from the next startup.



#### Additional Information

The magnetic pole position detection is performed to detect the positional relationship between magnetic pole and external scale.

By the magnetic pole position estimation method, the magnetic pole position is automatically estimated at the first Servo ON after the power supply is turned ON.

The estimated magnetic pole position is valid until the power supply is reset. After the reset, the magnetic pole position is estimated again at the first Servo ON.

Refer to the *Image Diagram of Magnetic Pole Position Estimation Method* on page 4-28.

Adjust the parameters if the estimation of the magnetic pole position failed.

Click the **Next** button.

### ● Image Diagram of Magnetic Pole Position Estimation Method

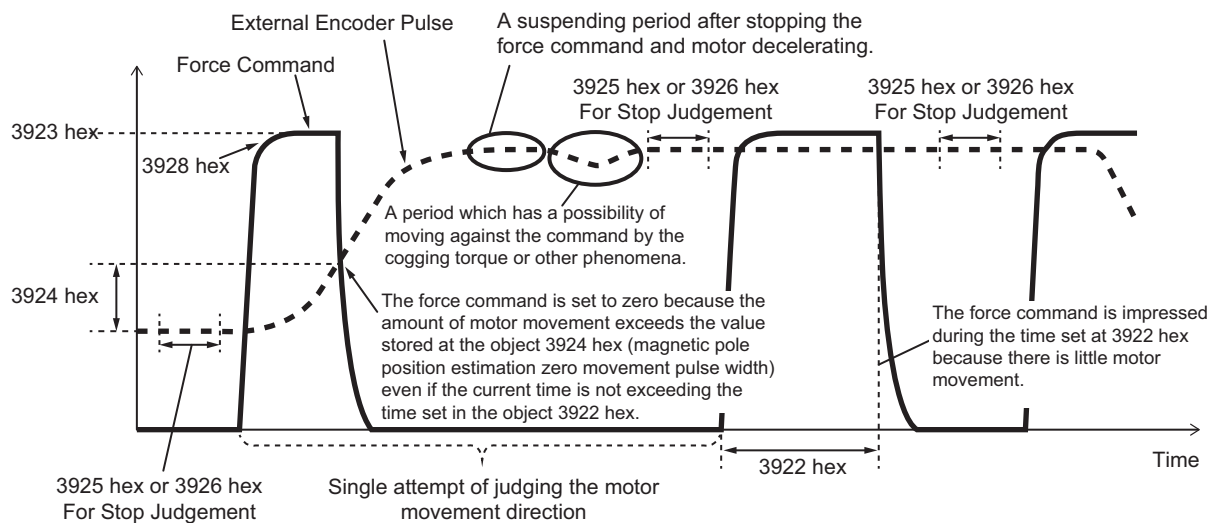

### ● Step 4: Result of Settings

Check the settings and click the **Transfer To Drive** button to save the settings to the non-volatile memory. If the Drive is offline, go online with the Drive. Refer to *2-7 Online Connection Procedure* on page 2-24 for details.

Before going to the next step, cycle the power supply to the Drive manually.

### ● Step 5: Motor System Auto Setup

The external scale and current loop gain of the linear motor will be set.

When you are ready, click the **Start** button.



#### **Precautions for Safe Use**

---

- After the completion of processing, the related parameters are automatically saved to the non-volatile memory.
  - Before moving to the next step, perform the following operations.
    - Go offline with the Servo Drive.
    - Cycle the power supply to the Servo Drive to apply the settings of the parameters that become valid at the startup.
    - If an EtherCAT cable is connected to the Servo Drive, remove it.
    - Go online with the Servo Drive.
- 



#### **Additional Information**

---

For the G5-series Servo Drives with built-in EtherCAT communications linear motor, an external scale is used instead of the conventional encoder that was built in the servomotor.

To run the motor efficiently, you need to make the optimum settings for the current gain. The setting is not required if you select a motor that does not need the automatic setting.

---

When the settings are completed, click the **Next** button.



#### **Precautions for Correct Use**

---

When you execute jogging, the motor will start running.

If the servo lock failed, return to Step 3 and check the magnetic pole settings.

When the test run is completed, click the **Next** button.

---

## ● Step 6: Finish

The parameter settings are complete. Cycle the power supply to the Servo Drive to apply the settings of the parameters that become valid at the startup.



---

### Additional Information

#### Often-displayed error codes:

- When Error 60.0 Motor Setup Error occurs, check the settings related to the motor and external scale.
- When Error 60.3 Motor Auto Setup Error occurs, select the correct model number of the linear motor.
- Error 87.0 Immediate Stop Input Error occurs when an immediate stop input (STOP) was input. Check the wiring, logic (NO/NC), and rising timing (not too late) of 12 to 24 VDC.
- When Error 38.0 Drive Prohibition Input Error 1 or Error 38.1 Drive Prohibition Input Error 2 occurs, check the switch connected to the positive/negative drive prohibition input, wiring, and power supply. Particularly, check if the rising timing of the power supply to the control signals (12 to 24 VDC) is not too late.
- When Error 16.0 Overload occurs, check for oscillation or up/down fluctuation of force (current) waveform caused by analog output or communications. Also, check for display of overload warnings and load factor through communications. Further, take the following countermeasures.

#### Countermeasures:

- Increase the capacity of the Servo Drive and the motor. Increase the acceleration/deceleration time. Reduce the load. Readjust the gain.
  - Correct the wiring of the motor according to the wiring diagram. Replace the cable. Straighten the machine. Reduce the load.
  - Measure the voltage of the brake terminal. Release the brake.
  - Correct the wirings to the motor and external scale to agree with the axes.
-

# 5

## Other Servo Drive Operations

---

This section describes the other functions of the Servo Drive operations.

---

5-1 Initialization of the Drive .....	5-2
5-2 Drive Properties .....	5-3

## 5-1 Initialization of the Drive

Right-click the Drive and select **Initialize** from the menu.

All parameters in the Drive will return to the factory settings.

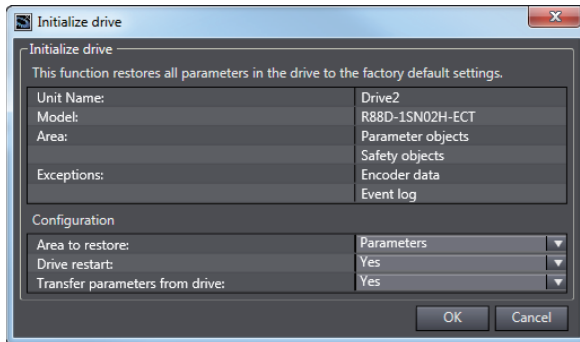

### ● Initializing the Drive

Make the settings for **Area to restore** and **Drive restart** in the **Configuration** area and click the **OK** button to initialize the Drive.

- Area to restore: Parameters, Safety, or Parameters and Safety
- Drive restart: Yes or No
- Transfer parameters from drive: Yes or No



### Additional Information

The settings of **Area to restore** and **Drive restart** can be edited only for 1S-series Servo Drives. When the Safety settings are included in the area to restore, the FSoE Slave Address (internal address used for safety process data communications) is initialized.

Drive restart is not available via Remote connection via CJ1W-NC□8□ Position Controller (EtherCAT).



## 5-2 Drive Properties

Right-click the Drive and select **Properties** from the menu.

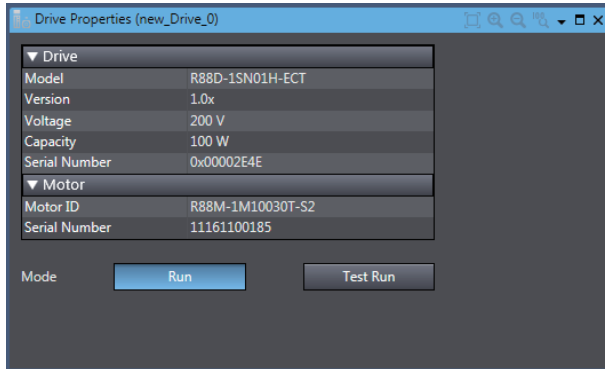

### ● Checking the Drive and Motor Properties

Check the model number, version, voltage, capacity, and serial number of the drive.

Check the motor ID and serial number of the motor.

Click the **Run** or **Test Run** button of **Mode** as necessary.

- Run button: The motor will run according to the commands from the Motion Controller. Operation commands cannot be sent from Sysmac Studio.
- Test Run button: The motor will run according to the commands from Sysmac Studio. Operation commands cannot be sent from the Motion Controller.





**OMRON Corporation    Industrial Automation Company**  
Kyoto, JAPAN

**Contact: [www.ia.omron.com](http://www.ia.omron.com)**

***Regional Headquarters***

**OMRON EUROPE B.V.**

Wegalaan 67-69, 2132 JD Hoofddorp  
The Netherlands  
Tel: (31)2356-81-300/Fax: (31)2356-81-388

**OMRON ELECTRONICS LLC**

2895 Greenspoint Parkway, Suite 200  
Hoffman Estates, IL 60169 U.S.A.  
Tel: (1) 847-843-7900/Fax: (1) 847-843-7787

**OMRON ASIA PACIFIC PTE. LTD.**

No. 438A Alexandra Road # 05-05/08 (Lobby 2),  
Alexandra Technopark,  
Singapore 119967  
Tel: (65) 6835-3011/Fax: (65) 6835-2711

**OMRON (CHINA) CO., LTD.**

Room 2211, Bank of China Tower,  
200 Yin Cheng Zhong Road,  
PuDong New Area, Shanghai, 200120, China  
Tel: (86) 21-5037-2222/Fax: (86) 21-5037-2200

**Authorized Distributor:**

© OMRON Corporation 2016 - 2020 All Rights Reserved.  
In the interest of product improvement,  
specifications are subject to change without notice.

**Cat. No. I589-E1-06**

0420