

Industrial PC Platform

NY-series

NYE Industrial PC

Operating Systems and Software Utilities Manual

NYE□□-□□5□□

NYE□□-□□N□□

NYE□□-□□S□□

NYE Industrial PC



NOTE

All rights reserved. No part of this publication may be reproduced, stored in a retrieval system, or transmitted, in any form, or by any means, mechanical, electronic, photocopying, recording, or otherwise, without the prior written permission of OMRON.

No patent liability is assumed with respect to the use of the information contained herein. Moreover, because OMRON is constantly striving to improve its high-quality products, the information contained in this manual is subject to change without notice. Every precaution has been taken in the preparation of this manual. Nevertheless, OMRON assumes no responsibility for errors or omissions. Neither is any liability assumed for damages resulting from the use of the information contained in this publication.

Trademarks

- Windows is a registered trademark of Microsoft Corporation in the USA and other countries.
- CFAST is a registered trademark of CompactFlash Association.
- Intel, the Intel Logo, Celeron and Intel Core are trademarks of Intel Corporation in the U.S. and/or other countries.

Other company names and product names in this document are the trademarks or registered trademarks of their respective companies.

Copyrights

Microsoft product screen shots reprinted with permission from Microsoft Corporation.

Introduction

Thank you for purchasing the NYE Industrial PC.

This manual contains information that is necessary to use the NYE Industrial PC (hereafter also named NYE IPC). Please read this manual and make sure you understand the functionality and performance of the NYE IPC before attempting to use it.

Keep this manual in a safe place where it will be available for reference during operation.

Intended Audience

This manual is intended for the following personnel, who must also have knowledge of software programming (a software engineer or the equivalent).

- Personnel in charge of introducing Factory Automation systems.
- Personnel in charge of designing Factory Automation systems.
- Personnel in charge of software design for Factory Automation systems.
- Personnel in charge of installing and maintaining and programming Factory Automation systems.
- Personnel in charge of managing Factory Automation systems and facilities.

Applicable Products

This manual covers following Industrial Panel PC products:

NYE□□-□□□□□-□□□□□□□□

Product	Model
NYE IPC with Windows 10	NYE□□-□□5□□
NYE IPC, with Windows 10 and Soft-NA	NYE□□-□□N□□
NYE IPC, with Windows 10 and NS software	NYE□□-□□S□□



Additional Information

Refer to *1-4 Product Configuration* on page 1-5 for configuration details.

Sections in this Manual

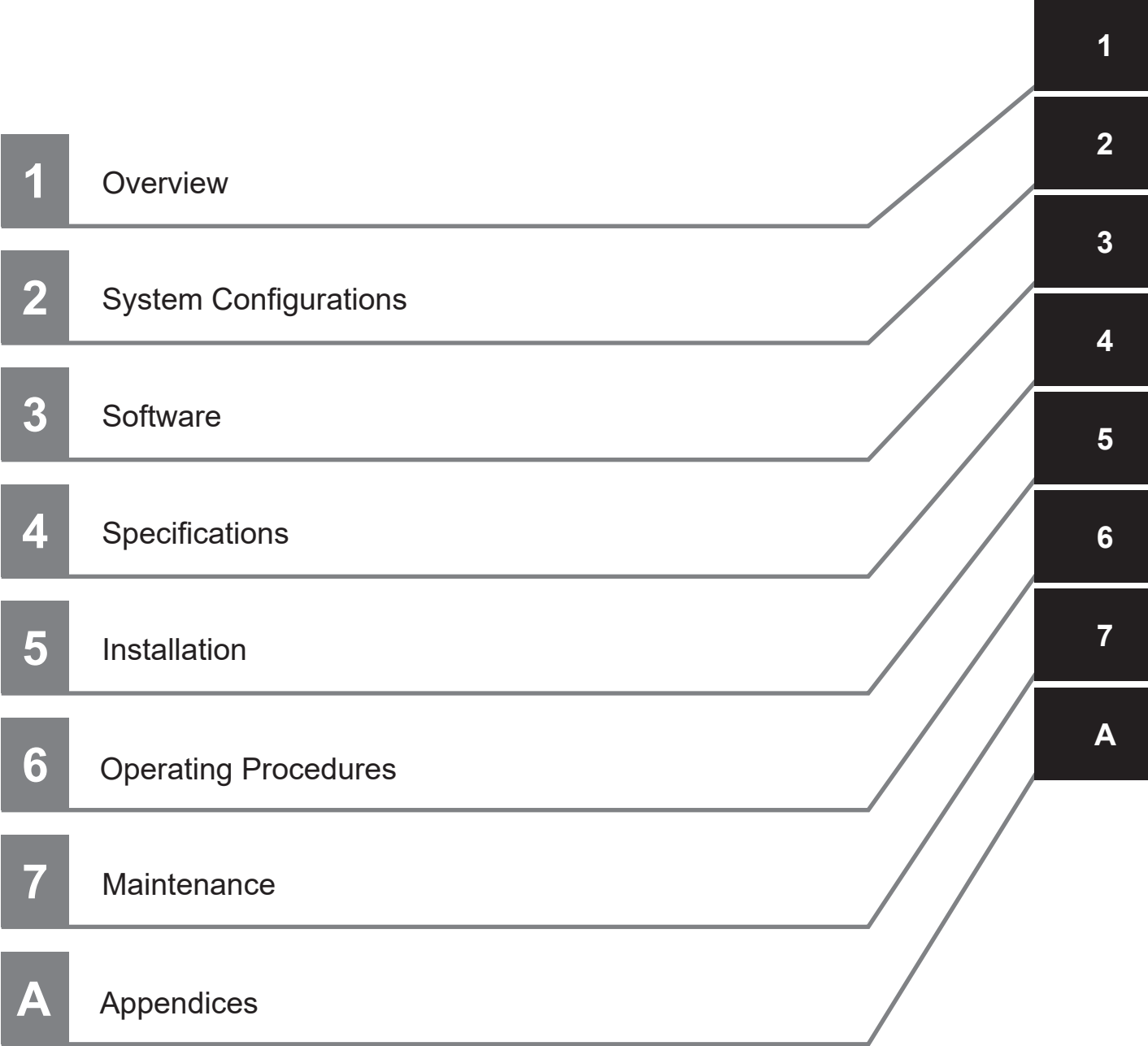

CONTENTS

Introduction	1
Intended Audience	1
Applicable Products	1
Sections in this Manual	3
Manual Information	7
Page Structure	7
Special Information	8
Terms and Conditions Agreement.....	9
Warranty and Limitations of Liability	9
Application Considerations	10
Disclaimers	11
Safety Precautions.....	12
Precautions for Safe Use	13
Precautions for Correct Use	14
Regulations and Standards	15
Conformance to EU Directives	15
Conformance to UL and CSA Standards	15
Software Licenses and Copyrights	16
Related Manuals.....	17
NYE Manuals	17
Terminology and Abbreviations	19
Industrial PC Platform	19
Software.....	19
Hardware	20
Revision History.....	21

Section 1 Overview

1-1 Intended Use	1-2
1-2 Software Features.....	1-3
1-3 ID Information Label	1-4
1-4 Product Configuration.....	1-5
1-5 Overall Setup Procedure	1-6

Section 2 System Configurations

2-1 Software Configuration	2-2
---	------------

Section 3 Software

3-1	Windows Operating System	3-3
3-1-1	Determine Your Version of the Windows Operating Systems	3-3
3-2	Overview IPC Support Software for Windows	3-4
3-3	Industrial PC Support Utility	3-5
3-3-1	Industrial PC Support Utility Overview	3-6
3-3-2	Product Information Tab	3-7
3-3-3	System Status Tab	3-8
3-3-4	UPS Status Tab	3-9
3-3-5	UPS Configuration Tab	3-12
3-3-6	Compatibility	3-13
3-3-7	Installation	3-13
3-3-8	Startup	3-13
3-3-9	Messages	3-14
3-3-10	Logging	3-14
3-4	Industrial PC Tray Utility	3-15
3-4-1	Industrial PC Tray Utility Overview	3-15
3-4-2	Features	3-15
3-4-3	Menu	3-16
3-4-4	About the Industrial PC Tray Utility	3-16
3-4-5	Status Indicators on Icons	3-17
3-4-6	Compatibility	3-17
3-4-7	Installation	3-17
3-4-8	Startup	3-18
3-5	Power Attendant Lite Utility	3-19
3-5-1	Power Attendant Lite Utility	3-19
3-5-2	Features	3-19
3-5-3	Compatibility	3-19
3-5-4	Installation	3-20
3-5-5	Configuration	3-21
3-6	Soft-NA	3-23
3-6-1	Installation	3-23
3-7	NS-Runtime	3-24
3-7-1	Installation	3-24
3-8	CX-Designer	3-25
3-9	COM Port for Host Link	3-26
3-9-1	Install the Virtual COM Port	3-26
3-9-2	Determine the COM Port Number for Host Link	3-26

Section 4 Specifications

4-1	Software Specifications	4-2
4-1-1	Compatible and Available Operating Systems	4-2

Section 5 Installation

5-1	Install Software	5-2
5-1-1	Windows Startup First Time	5-2
5-1-2	Main Application	5-3
5-1-3	Internet Browser	5-4
5-1-4	Firewall	5-4
5-1-5	Anti-virus Software	5-4
5-1-6	Drivers and Custom Software	5-7
5-1-7	Activate Windows	5-7
5-1-8	Customize Windows	5-7

5-1-9	Disable Scheduled Defragmentation.....	5-8
5-2	Install Support Software.....	5-9
5-2-1	Overview IPC Support Software for Installation	5-9
5-3	Create Backup and Repair Data of the Installation	5-10

Section 6 Operating Procedures

6-1	React to Product Messages	6-2
6-2	React to Windows Messages.....	6-3

Section 7 Maintenance

7-1	Preventive Maintenance	7-2
7-1-1	Preventive Maintenance Schedule.....	7-2
7-1-2	Keep Software Updated	7-2
7-1-3	Overview of Recover, Restore and Repair Methods for NYE	7-3
7-2	Corrective Maintenance	7-10
7-2-1	Warning and Error Messages.....	7-10
7-2-2	Allocate a Drive in Windows.....	7-12
7-2-3	Windows Event Viewer.....	7-13
7-2-4	Windows Low on Memory	7-15
7-2-5	Windows Blue Screens	7-16
7-2-6	Correct Display Functionality when Nothing is Displayed	7-16
7-2-7	Correct Touchscreen Functionality	7-17
7-2-8	Restore a Custom Backup with Windows	7-18

Appendices

A-1	Customize Windows	A-2
A-1-1	Unified Write Filter.....	A-2
A-1-2	Trusted Platform Module	A-3

Index

Manual Information

This section provides information about this manual.

Page Structure

The following page structure is used in this manual.

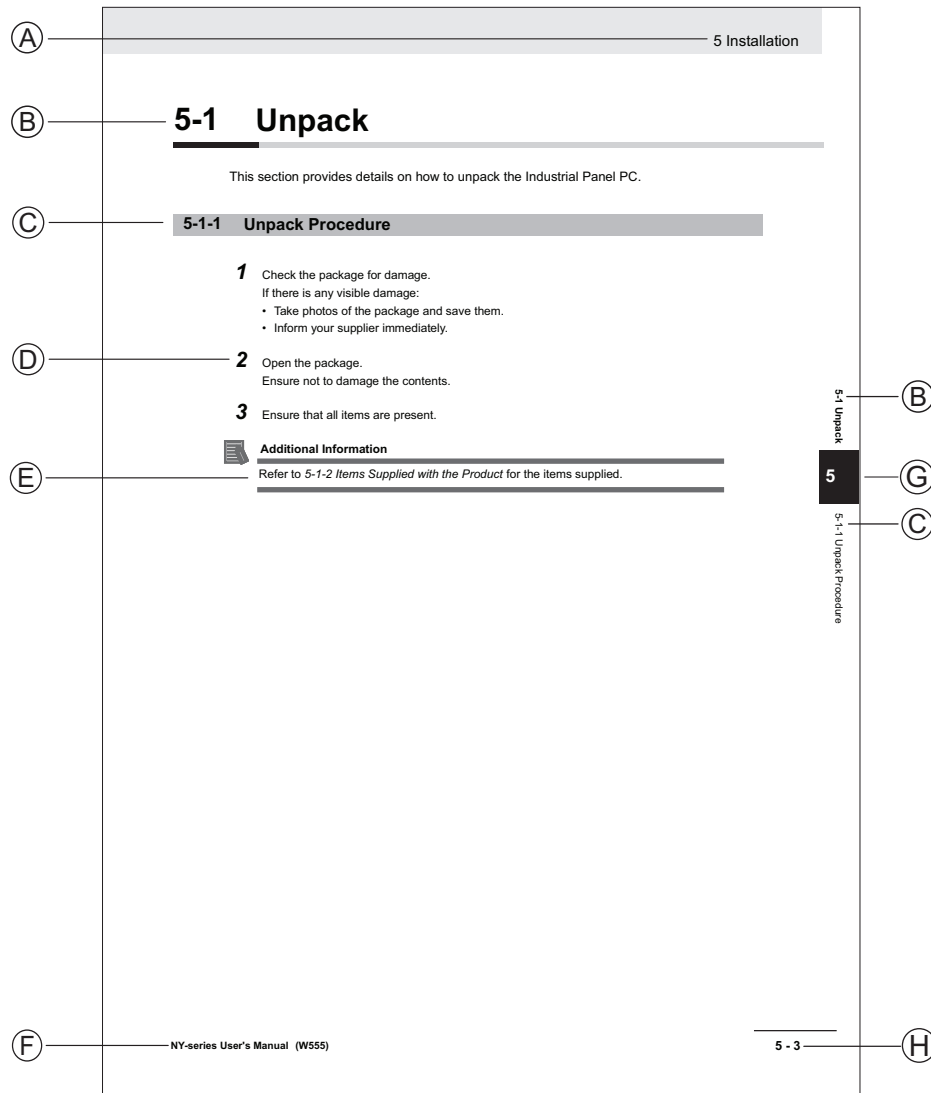

Note: This illustration is provided as a sample. It will not literally appear in this manual.

Item	Explanation	Item	Explanation
A	Level 1 heading	E	Special Information
B	Level 2 heading	F	Manual name
C	Level 3 heading	G	Page tab with the number of the main section
D	Step in a procedure	H	Page number

Special Information

Special information in this manual is classified as follows:



Precautions for Safe Use

Precautions on what to do and what not to do to ensure safe usage of the product.



Precautions for Correct Use

Precautions on what to do and what not to do to ensure proper operation and performance.



Additional Information

Additional information to read as required.

This information is provided to increase understanding or make operation easier.



Version Information

Information on differences in specifications and functionality between different versions.

Terms and Conditions Agreement

Warranty and Limitations of Liability

WARRANTY

- The warranty period for the Software is one year from the date of purchase, unless otherwise specifically agreed.
- If the User discovers defect of the Software (substantial non-conformity with the manual), and return it to OMRON within the above warranty period, OMRON will replace the Software without charge by offering media or download from OMRON's website. And if the User discovers defect of media which is attributable to OMRON and return it to OMRON within the above warranty period, OMRON will replace defective media without charge. If OMRON is unable to replace defective media or correct the Software, the liability of OMRON and the User's remedy shall be limited to the refund of the license fee paid to OMRON for the Software.

LIMITATION OF LIABILITY

- THE ABOVE WARRANTY SHALL CONSTITUTE THE USER'S SOLE AND EXCLUSIVE REMEDIES AGAINST OMRON AND THERE ARE NO OTHER WARRANTIES, EXPRESSED OR IMPLIED, INCLUDING BUT NOT LIMITED TO, WARRANTY OF MERCHANTABILITY OR FITNESS FOR PARTICULAR PURPOSE. IN NO EVENT, OMRON WILL BE LIABLE FOR ANY LOST PROFITS OR OTHER INDIRECT, INCIDENTAL, SPECIAL OR CONSEQUENTIAL DAMAGES ARISING OUT OF USE OF THE SOFTWARE.
- OMRON SHALL HAVE NO LIABILITY FOR DEFECT OF THE SOFTWARE BASED ON MODIFICATION OR ALTERNATION TO THE SOFTWARE BY THE USER OR ANY THIRD PARTY. OMRON SHALL NOT BE RESPONSIBLE AND/OR LIABLE FOR ANY LOSS, DAMAGE, OR EXPENSES DIRECTLY OR INDIRECTLY RESULTING FROM THE INFECTION OF OMRON PRODUCTS, ANY SOFTWARE INSTALLED THEREON OR ANY COMPUTER EQUIPMENT, COMPUTER PROGRAMS, NETWORKS, DATABASES OR OTHER PROPRIETARY MATERIAL CONNECTED THERETO BY DISTRIBUTED DENIAL OF SERVICE ATTACK, COMPUTER VIRUSES, OTHER TECHNOLOGICALLY HARMFUL MATERIAL AND/OR UNAUTHORIZED ACCESS.
- OMRON SHALL HAVE NO LIABILITY FOR SOFTWARE DEVELOPED BY THE USER OR ANY THIRD PARTY BASED ON THE SOFTWARE OR ANY CONSEQUENCE THEREOF.

Application Considerations

APPLICABLE CONDITIONS

A USER SHALL NOT USE THE SOFTWARE FOR ANY PURPOSE THAT IS NOT PROVIDED IN THIS MANUAL OR IN A RELATED HARDWARE USER'S MANUAL.

Suitability of Use

Omron Companies shall not be responsible for conformity with any standards, codes or regulations which apply to the combination of the Product in the Buyer's application or use of the Product. At Buyer's request, Omron will provide applicable third party certification documents identifying ratings and limitations of use which apply to the Product. This information by itself is not sufficient for a complete determination of the suitability of the Product in combination with the end product, machine, system, or other application or use. Buyer shall be solely responsible for determining appropriateness of the particular Product with respect to Buyer's application, product or system. Buyer shall take application responsibility in all cases.

NEVER USE THE PRODUCT FOR AN APPLICATION INVOLVING SERIOUS RISK TO LIFE OR PROPERTY OR IN LARGE QUANTITIES WITHOUT ENSURING THAT THE SYSTEM AS A WHOLE HAS BEEN DESIGNED TO ADDRESS THE RISKS, AND THAT THE OMRON PRODUCT(S) IS PROPERLY RATED AND INSTALLED FOR THE INTENDED USE WITHIN THE OVERALL EQUIPMENT OR SYSTEM.

Programmable Products

- Omron Companies shall not be responsible for the user's programming of a programmable Product, or any consequence thereof.
- Omron Companies shall not be responsible for the operation of the user accessible operating system (e.g. Windows, Linux), or any consequence thereof.

Disclaimers

Performance Data

Data presented in Omron Company websites, catalogs and other materials is provided as a guide for the user in determining suitability and does not constitute a warranty. It may represent the result of Omron's test conditions, and the user must correlate it to actual application requirements. Actual performance is subject to the Omron's Warranty and Limitations of Liability.

Change in Software Specifications

The software specifications and accessories may be changed at any time based on improvements and other reasons.

Errors and Omissions

Information presented by Omron Companies has been checked and is believed to be accurate; however, no responsibility is assumed for clerical, typographical or proofreading errors or omissions.

Safety Precautions

Information is available in the related manual *NY-series NYE Industrial Panel PC Hardware User's Manual (Cat.No. W634)*.

Precautions for Safe Use

Information is available in the related manual *NY-series NYE Industrial Panel PC Hardware User's Manual (Cat.No. W634)*.

Precautions for Correct Use

Information is available in the related manual *NY-series NYE Industrial Panel PC Hardware User's Manual (Cat.No. W634)*.

Regulations and Standards

Conformance to EU Directives

The NYE Industrial PC complies with EU Directives. To ensure that the machine or device in which the NYE IPC is used complies with EU Directives, the following precautions must be observed:

- The NYE IPC must be installed within a control panel.
- The NYE IPC that complies with EU Directives also conforms to the Common Emission Standard. Radiated emission characteristics may vary depending on the configuration of the control panel used, other devices connected to the control panel, wiring, and other conditions. You must therefore confirm that the overall machine or equipment in which the NYE IPC is used complies with EU Directives.
- This is a Class A product (for industrial environments). In a residential environment, it may cause radio interference. If radio interference occurs, the user may be required to take appropriate measures.

Applicable Directive

EMC Directive

EMC Directive

OMRON devices that comply with EU Directives also conform to the related EMC standards so that they can be more easily built into other devices or the overall machine. The actual products have been checked for conformity to EMC standards.

Applicable EMC (Electromagnetic Compatibility) standards are as follows:

- EMS (Electromagnetic Susceptibility): EN 61131-2
- EMI (Electromagnetic Interference): EN 61131-2

Whether the products conform to the standards in the system used by the customer, however, must be checked by the customer. EMC-related performance of the OMRON devices that comply with EU Directives will vary depending on the configuration, wiring, and other conditions of the equipment or control panel on which the OMRON devices are installed. The customer must, therefore, perform the final check to confirm that devices and the overall machine conform to EMC standards.

Conformance to UL and CSA Standards

Some Industrial PC Platform products comply with UL and CSA standards. If you use a product that complies with UL or CSA standards and must apply those standards to your machinery or devices, refer to this manual. This manual provides the application conditions for complying with the standards. If the product is used in a manner not specified in the Instruction Sheet or in the product manuals then the protection provided by the equipment may be impaired.

Software Licenses and Copyrights

This product incorporates certain third party software. The license and copyright information associated with this software is available at https://www.fa.omron.co.jp/nj_info_e/.

Related Manuals

The following manuals are related. Use these manuals for reference.

NYE Manuals

This table contains the related manual of the NYE-series products.

Manual name	Cat. No.	Model numbers	Application	Description
NYE-series Industrial Panel PC Hardware User's Manual	W634	NYE□□-□ □□□□	Learning all basic information about the NYE IPC. This includes introductory information with features, hardware overview, specifications, mounting, wiring, connecting, operating and maintaining the Industrial Monitor.	An introduction to the NYE IPC is provided along with the following information: <ul style="list-style-type: none"> • Overview • Hardware • Software • Specifications • Installation • Operating Procedures • Maintenance
NYE-series Industrial PC Operating Systems and Software Utilities Manual	W635	NYE□□-□ □5□□ NYE□□-□ □N□□ NYE□□-□ □S□□	Learning all software related information about the NYE IPC. This includes introductory information, installation, operating procedures and maintenance. Mainly software information is provided.	An introduction to the NYE IPC is provided along with the following information: <ul style="list-style-type: none"> • Overview • Software • Specifications • Installation • Operating Procedures • Maintenance
NY-series Industrial Panel PC FHV7 Software, Setup and Operation Manual	W642	NYE□□-□ □F□□	Learning all software related information about the NYE IPC with FHV7 Software.	An introduction to the NYE IPC with FHV7 Software is provided along with the following information: <ul style="list-style-type: none"> • Overview • Software • Specifications • Operating Procedures • Maintenance
NS-Runtime	V093	NYE□□-□ □S□□	Learning all software related information about NS-Runtime	An introduction to NS-Runtime with the following information: <ul style="list-style-type: none"> • Overview • User Interface • Installation • Basic Operations • Application Methods
CX-Designer User's Manual	V099	NYE□□-□ □S□□	Learning all software related information about CX-Designer	An introduction to CX-Designer with the following information: <ul style="list-style-type: none"> • Overview • User Interface • Installation • Basic Operations • Application Methods

Manual name	Cat. No.	Model numbers	Application	Description
NA-series Soft-NA User's Manual	V126	NYE□□-□ □N□□	Learning all software related information about Soft-NA	An introduction to soft-NA is provided along with the following information: <ul style="list-style-type: none"> • Overview • Software • Specifications • Programming • Operating Procedures

Terminology and Abbreviations

Industrial PC Platform

Term / Abbreviation	Description
Industrial PC Platform	An integrated range of OMRON products designed for use in any industrial application that will benefit from advanced PC technology
Industrial Monitor	An industrial monitor with a touchscreen as the user interface designed to work in industrial environments
Industrial Panel PC	An industrial PC with an integrated touchscreen monitor designed to work in industrial environments
Industrial Box PC	A box-shaped industrial PC including an OS designed to work in industrial environments
IPC	Industrial PC

Software

Term / Abbreviation	Description
BIOS	Basic Input Output System. The first software run by a PC when powered on.
DST	Daylight Saving Time
IIoT	Industrial Internet of Things
Linux	An open source Operating System
MBR	Master Boot Record
Merge module	A module providing a standard method by which developers deliver shared Windows installer components and setup logic to their applications
MSDN	Microsoft Developer Network
NUI	Natural User Interface
OS	Operating System
TCP/IP	Transmission Control Protocol / Internet Protocol, a core member of the Internet protocol suite
TPM	Trusted Platform Module
Windows	An Operating System designed by Microsoft

Hardware

Term / Abbreviation	Description
3D TLC	3D Triple-Level Cell flash memory
CFast	An SSD CFast storage device
CPU	A Central Processing Unit is the hardware within a computer that executes the instructions of a computer program
Ethernet	A network communication protocol used in TCP/IP network
HMI	A Human Machine Interface that facilitates machine operation and control
SATA	The Serial AT Attachment is a serial bus interface primarily used with mass storage devices such as hard disk drives
USB	Universal Serial Bus

Revision History

A manual revision code appears as a suffix to the catalog number on the front and back covers of the manual.

Cat. No. W635-E2-03

Concept for

↑
Revision code

Revision code	Date	Revised content
03	February 2024	<ul style="list-style-type: none">• Added new OS options 5 and N• Modifications due to added OS options
02	December 2022	<ul style="list-style-type: none">• Corrected model-ID on frontcover• Minor modifications
01	September 2022	First release



Overview

This section provides general information about the NYE Industrial PC.

1-1	Intended Use	1-2
1-2	Software Features	1-3
1-3	ID Information Label.....	1-4
1-4	Product Configuration	1-5
1-5	Overall Setup Procedure	1-6

1-1 Intended Use

The Industrial PC is intended to be used in factory automation environments. This Industrial PC can be configured with Windows, Linux or a realtime operating system (RTOS). Software utilities extend the functionality and support the functional integration in custom software. It can be used with third party software to serve as a powerful PC platform.

A user can access the Industrial PC for control, configuration and supervisory operations.

The Industrial PC can easily be integrated in manufacturing innovations like big data, NUI and IIoT.

The Industrial PC has a compact design that offers flexibility, expandability and easy maintenance for applications in factory automation environments.

1-2 Software Features

The Industrial PC provides the following software features:

- Operating Systems
The system can be delivered with and without an operating system.
- Software Utilities
A software utility provides status details for diagnosing and resolving problems.

1-3 ID Information Label

The ID information label contains the product configuration and other details on the specific configuration of your Industrial PC.

Information is available in the related manual *NY-series NYE Industrial Panel PC Hardware User's Manual (Cat.No. W634)*.

1-4 Product Configuration

This section provides an overview of the product configurations available for the NYE IPC.

The product configuration is visible in the model-ID that is mentioned on the ID information label of the NYE IPC.

The structure of the model-ID is: NYE□□-□□□□□-□□□□□□□□.

Each item in the model-ID has a specific meaning.

NYE □□ - □□□□□ - □□□□□□□□
 1 2 3 4 5 6 7 8 9 10 11 12 13 14

Item	Description	Option / Description
1	Series name	NYE: NYE- series NYE IPC
2	CPU	2A: Intel Atom E3940 CPU
3	Memory	2: DDR3L 4 GB no ECC
4	Expansion	0: No expansion
5	Operating System / Software	5: Windows 10 IoT Enterprise 2021 LTSC - 64 bit F: Windows 10 IoT Enterprise 2021 LTSC - 64 bit with FHV7 N: Windows 10 IoT Enterprise 2021 LTSC - 64 bit with Soft-NA S: Windows 10 IoT Enterprise 2021 LTSC - 64 bit with NS software
6	Storage	1: 128GB, CFast 3DTLC
7	Interfaces	1: RS-232C
8	Display size (diagonal)	07: 7.0 inch model 09: 9.0 inch model 12: 12.1 inch model 15: 15.4 inch model
9	Aspect ratio	W: Wide
10	Touchscreen	R: Resistive
11	Frame-type	1: Panel mount
12	Front material & Color	2: Body Aluminium Black + Frontsheet Black 3: Body Aluminium Black + Frontsheet Silver
13	Build-in options	0: None
14	Customization	0: None

1-5 Overall Setup Procedure

This section gives the overall setup procedure for the Industrial PC.

This manual presents this information in the same order as the following setup procedure.

To setup the Industrial PC:

1 Familiarize yourself with the Industrial PC

- Refer to the sections Overview and Hardware of the Hardware manual.

Information is available in the related manual *NY-series NYE Industrial Panel PC Hardware User's Manual (Cat.No. W634)*.

- Refer to the information in this manual.

Specifically refer to the sections:

- *Section 2 System Configurations* on page 2-1
- *Section 3 Software* on page 3-1
- *Section 4 Specifications* on page 4-1

2 Install the IPC Hardware

Perform the procedures that are required to use the Industrial PC such as installation, and connection with peripheral devices including a UPS.

Refer to the section Installation in the Hardware manual..

3 Setup the IPC

Install and configure the operating system, the software support utilities and the UPS software.

Item	Remark	Reference
Operating system settings	Follow the procedure for 'First time startup'	The applicable Hardware Manual, see step 1.
UPS settings	Make the required UPS settings	The applicable UPS Manual

Adjust the brightness and contrast of the monitor.

4 Operate the IPC

Use the operating procedures to operate the Industrial PC.

Refer to the sections Operating Procedures in this manual and in the Hardware manual.

The setup of the Industrial PC is finished.

The section 'Maintenance' contains preventive and corrective maintenance information.

Refer to the section Maintenance in this manual and in the Hardware manual.



System Configurations

This section provides an overview of the system configurations for the NYE Industrial PC.

2-1 Software Configuration..... 2-2

2-1 Software Configuration

The NYE Industrial PC supports the following software configurations.

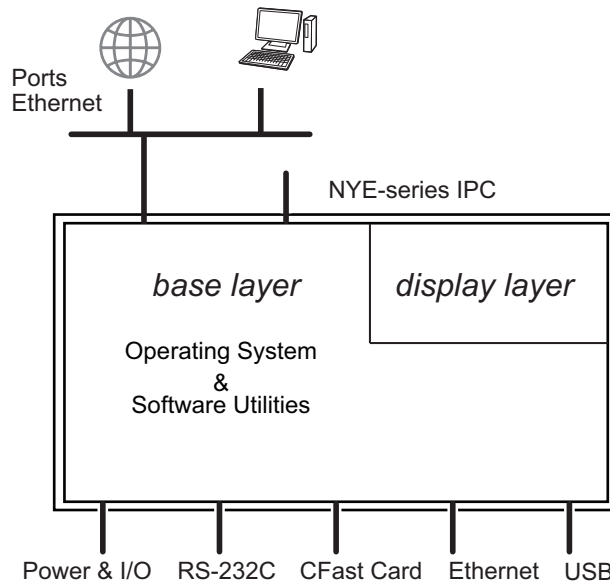

The operating system is the foundation for your software environment. The operating system manages the IPC hardware and supplies an interface for the users.

Refer to *3-1 Windows Operating System* on page 3-3 for details.

Support software is a collection of software utilities to support and extend the functionality of your Industrial PC.

Refer to *3-2 Overview IPC Support Software for Windows* on page 3-4 for details.

3

Software

This section provides software information for the NYE Industrial PC.

3-1	Windows Operating System	3-3
3-1-1	Determine Your Version of the Windows Operating Systems	3-3
3-2	Overview IPC Support Software for Windows	3-4
3-3	Industrial PC Support Utility	3-5
3-3-1	Industrial PC Support Utility Overview	3-6
3-3-2	Product Information Tab	3-7
3-3-3	System Status Tab	3-8
3-3-4	UPS Status Tab	3-9
3-3-5	UPS Configuration Tab.....	3-12
3-3-6	Compatibility.....	3-13
3-3-7	Installation	3-13
3-3-8	Startup.....	3-13
3-3-9	Messages.....	3-14
3-3-10	Logging.....	3-14
3-4	Industrial PC Tray Utility	3-15
3-4-1	Industrial PC Tray Utility Overview	3-15
3-4-2	Features	3-15
3-4-3	Menu	3-16
3-4-4	About the Industrial PC Tray Utility.....	3-16
3-4-5	Status Indicators on Icons	3-17
3-4-6	Compatibility.....	3-17
3-4-7	Installation	3-17
3-4-8	Startup.....	3-18
3-5	Power Attendant Lite Utility	3-19
3-5-1	Power Attendant Lite Utility	3-19
3-5-2	Features	3-19
3-5-3	Compatibility.....	3-19
3-5-4	Installation	3-20
3-5-5	Configuration	3-21
3-6	Soft-NA	3-23
3-6-1	Installation	3-23
3-7	NS-Runtime	3-24
3-7-1	Installation	3-24
3-8	CX-Designer	3-25
3-9	COM Port for Host Link	3-26
3-9-1	Install the Virtual COM Port.....	3-26

3-9-2 Determine the COM Port Number for Host Link..... 3-26

3-1 Windows Operating System

This section provides an overview of Windows Operating System information.

3-1-1 Determine Your Version of the Windows Operating Systems

This section provides methods to find version details of your Windows Operating System.

Windows 10

To determine your version of the Windows Operating System:

- 1** Select the **Search** Button.
- 2** Enter *System Information* in the search box.
- 3** Select **System Information** in the pop-up that appears.
An overview of your System Information will appear, including the Windows Operating System details.

3-2 Overview IPC Support Software for Windows

This section gives an overview of the software utilities available for NYE NYE Industrial PC's with a Windows operating system.

Product	Software utility
Industrial Panel PC	Industrial PC Support Utility Industrial PC Tray Utility *1*2

*1. Included in the Industrial PC Support Utility installer

*2. Together with the Industrial PC Tray Utility also Microsoft .NET Framework 4.6 is installed.

Select and download the required utility from [the OMRON website](#).



Additional Information

An internet connection is required to install support software.

3-3 Industrial PC Support Utility

This section provides an overview of the Industrial PC Support Utility.

3-3-1 Industrial PC Support Utility Overview

The Industrial PC Support Utility is a software utility to assist in diagnosing and resolving problems of the NYE Industrial PC.

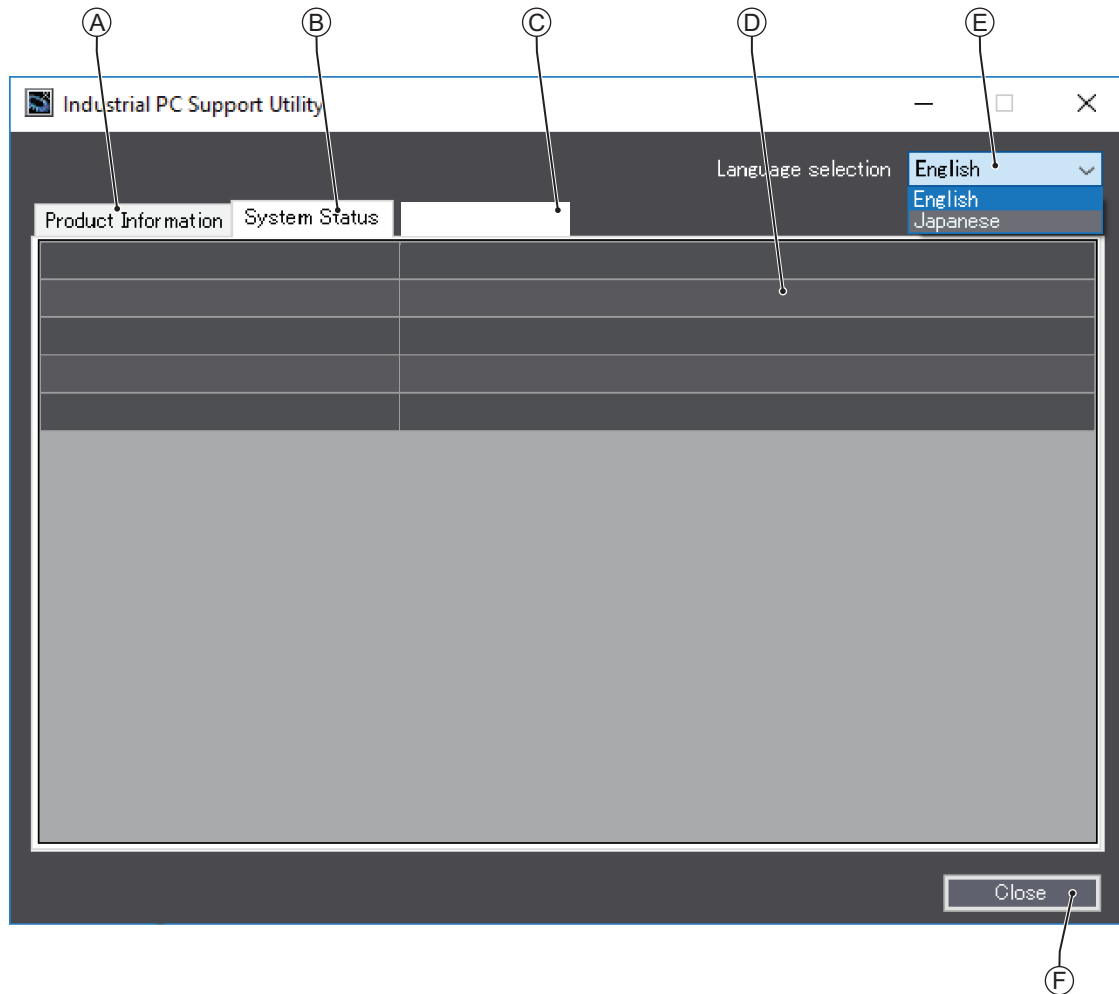

The screen above is an example only, the actual content can differ per model.

Item	Description	Details
A	Production Data Tab	Select to display Production Data details in the Tab details area (D). Refer to 3-3-2 <i>Product Information Tab</i> on page 3-7 for details.
B	System Status Tab	Select to display System Status details in the Tab details area (D). Refer to 3-3-3 <i>System Status Tab</i> on page 3-8 for details.
C	Optional other Tabs	Optional other Tabs
D	Tab details	Details of the selected Tab page.
E	Language Selector	Select to display and choose the UI language of the Industrial PC Support Utility.
F	Close Button	Close the Industrial PC Support Utility.

3-3-2 Product Information Tab

The Production Data tab displays generic NYE Industrial PC information.

Examples are Model name, Lot number, Serial number and software versions (Industrial PC Support Utility and Industrial PC System API).

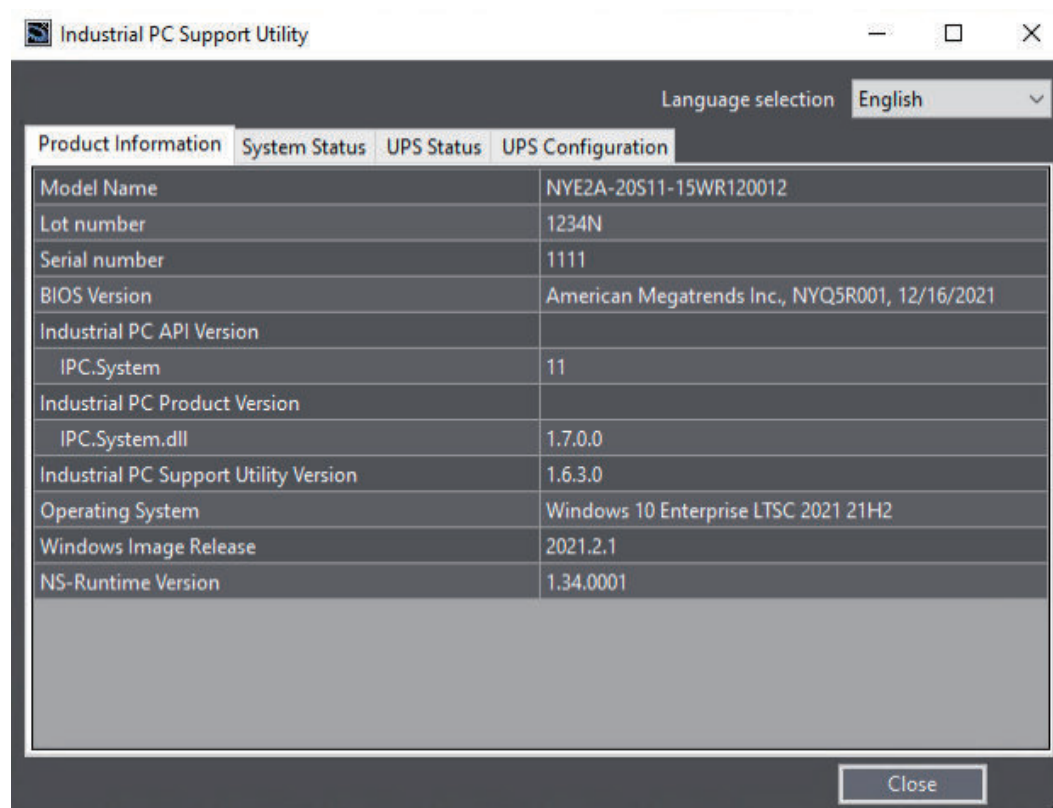

- Model Name is the configuration code of this model.
Refer to *1-4 Product Configuration* on page 1-5 for details.

Item	Displayed information
Model Name	The model number of the Industrial PC
Lot number	The lot number of the Industrial PC
Serial number	The serial number of the Industrial PC
BIOS Version	The BIOS version of the Industrial PC
Industrial PC API Version	The version of API installed in Windows
IPC.System	The API for the Industrial PC system
Industrial PC Product Version	The product version of the library installed in Windows
IPC.System.dll	The library for the Industrial PC system
Industrial PC Support Utility Version	The version of the Industrial PC Support Utility
Operating System	The installed Operating System
Windows Image Release	The date of the Windows Image
NS-Runtime Version	The version of the NS Runtime software

3-3-3 System Status Tab

The System Status tab displays the actual states and diagnostic information like the internal temperature with a refresh rate of 2 seconds.

A status that requires attention is indicated with a red bar.

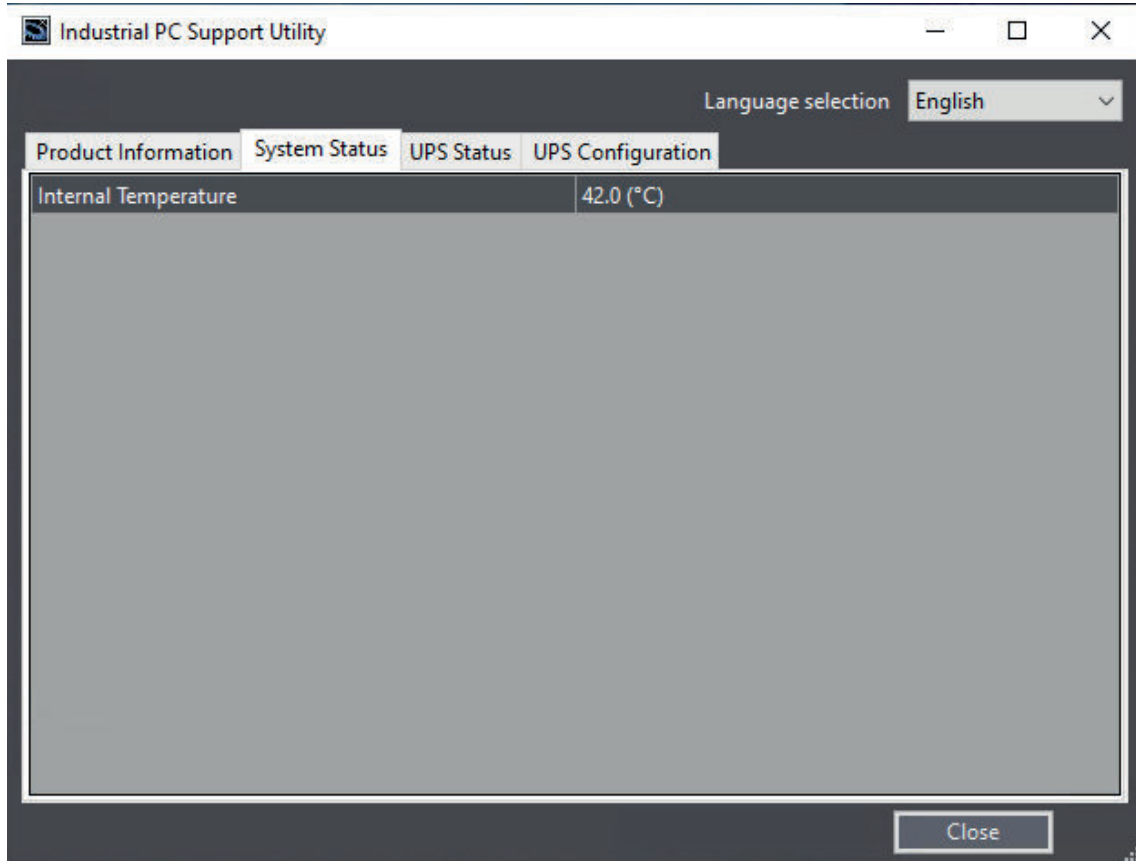

Item	Description
Internal Temperature	The average CPU temperature.

3-3-4 UPS Status Tab

The UPS Status tab displays status details about the UPS and the PAL Utility when applicable.

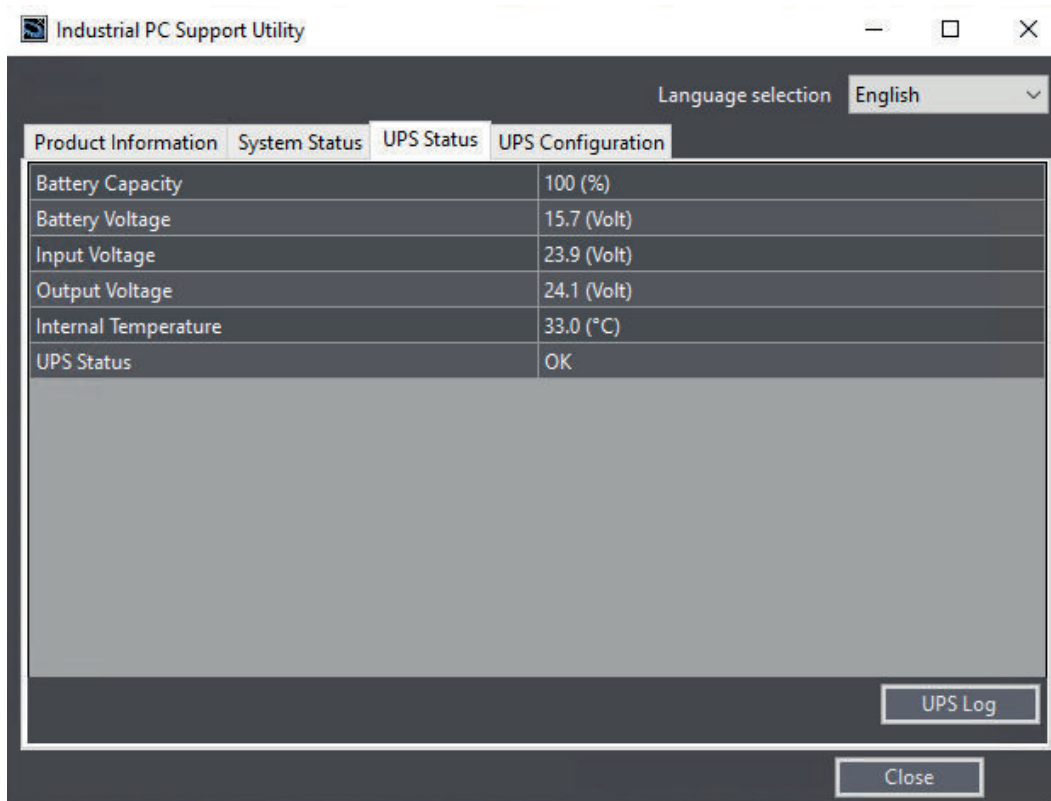

Item	Description
Battery Capacity	The percentage of remaining Battery capacity. *1 This parameter can trigger messages 'Battery Low' and 'Battery Weak'.
Battery Voltage	The voltage of the UPS Battery. *1 This parameter can trigger messages 'Battery Under Charge' and 'Battery Over Charge'.
Input Voltage	The actual UPS input voltage. *1 This parameter can trigger the message 'UPS Input Fail'.
Output Voltage	The actual UPS output voltage. *1 This parameter can trigger the message 'UPS Output Low Voltage', 'UPS Output High Voltage'.
Internal Temperature	The UPS internal temperature. *1 This parameter can trigger the message 'UPS Over temperature'.
UPS Status	The status of the UPS. Refer to <i>UPS Status</i> on page 3-10 for details.

*1. - - - is displayed when the UPS Status is 'Disconnected' or 'PAL Utility is Running'.

Select button UPS Logs to display the 'UPS Logs'-window.

Select your UPS loggings and then select 'Download' to download the logging.

UPS Status

The UPS Diagnostics tab displays the UPS status.

The status with the highest priority is displayed in the notification window of the Industrial PC Tray Utility.

Refer to *3-4 Industrial PC Tray Utility* on page 3-15 for details.

Following statuses are available:

Category	Message	Description
Normal	OK	UPS is ON (running state)
	OFF	UPS is OFF (idle state)
	Disconnected	No USB connection between UPS and IPC
	PALRunning	PAL utility is installed and running on the IPC
Warning	ConnectionLost	Connection to UPS is lost
	BatteryLow	Battery low threshold exceeded
	BatteryWeak	Battery is weak
	BatteryLost	Battery is disconnected
	UPSOverload	Overload is detected
	UPSOverloadTimeout	Overload timeout
	UPSOutputShort	Short-circuit detected at output
	BatteryUnderCharge	Battery is undercharged
	UPSOverTemperature	Temperature is too high
	UPSOutputLowVoltage	Output voltage is too low
	Sc20gConflict	SC20G wear detected
Error	BatteryOverCharge	Battery is overcharged
	UPSInputFail	Primary power supply failure
	UPSBypass	Error during bypass operation
	UPSBoost	Boosting power
	UPS Buck	Bucking power
	UPSOutputOverVoltage	Output voltage is too high
	UPSDcBusVoltage	DC bus voltage error
	FanFail	Fan error
	TransformerFail	Transformer error
	BatteryLifeOver	Battery is at end-of-life
	BmsOverCurrent	BMS overcurrent
	BmsInternalError	BMS internal error
	ChargerFail	Charger failure
	BmsOverVoltage	BMS cell overvoltage
	BmsUnderVoltage	BMS cell undervoltage
BatteryMisconnect	Battery is not connected correctly	

UPS Log

Select button **UPS Logs** to display the UPS log file.

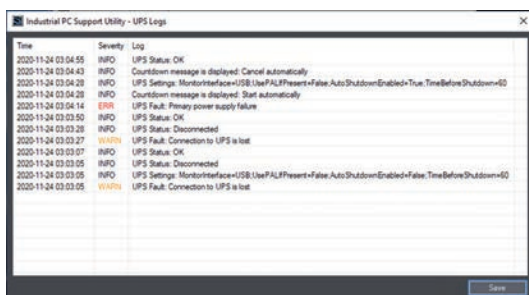

Select **Save** to save the log file to the location of your choice.



Additional Information

- The contents is updated every 2 seconds.
- The logged events are available in the Windows EventLog in **IPCSupportUtility** and in **UpsSource**.

3-3-5 UPS Configuration Tab

The UPS Configuration tab starts with the UPS details Model name, Serial number and UPS driver version of the connected UPS. The UPS Configuration tab displays the Interface Settings and Shutdown Settings for a connected UPS.

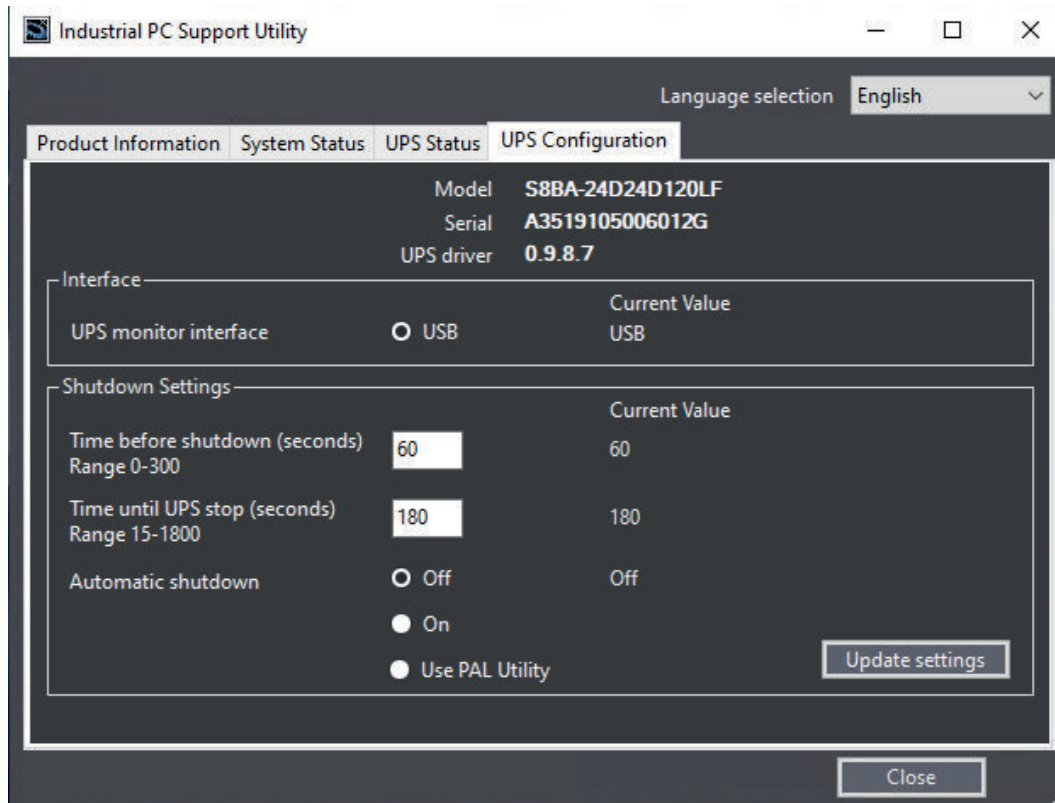

Item		Description
Interface	UPS monitor Interface	Select the settings for the interface cable connected to detect the power interruption signal from the UPS.
Shutdown Settings	Time before shutdown	The number of seconds after the UPS shutdown that Windows waits to shutdown the IPC.
	Time until UPS stops	The number of seconds after the Windows shutdown UPS output switches OFF.
	Automatic Shutdown	The IPC automatic shutdown settings with: <ul style="list-style-type: none"> Off: The Industrial PC Support Utility will monitor the UPS status, but not execute the IPC shutdown. On: The Industrial PC Support Utility will monitor the UPS status and determine to the IPC shutdown. Use PAL Utility: PAL Utility will monitor the UPS status and determine to the IPC shutdown. ^{*1}

- *1. The Power Attendant Lite Utility is a software utility that constantly monitors the status of the UPS that is connected to the NYE IPC.
When the Power Attendant Lite Utility discovers a power interruption it will send a signal to the NYE IPC to shut down.
Behavior with setting 'Use Pal Utility':
- PAL Utility not installed.
The IPC will not automatically shutdown. The Industrial PC Support Utility will stay connected to the UPS.
 - PAL Utility installed but not active.
The IPC will not automatically shutdown. The Industrial PC Support Utility is not connected to the UPS.
 - PAL Utility installed and active.

The IPC will automatically shutdown. The Industrial PC Support Utility is not connected to the UPS. When changing from “Use PAL Utility” to “ON” or to “OFF”, the PAL Agent service will stop.



Precautions for Correct Use

The Industrial PC Support Utility uses the UPS configuration using the same communication channels. Therefore, the Industrial PC Support Utility and PAL Utility cannot be used at the same time.

3-3-6 Compatibility

Compatibility with Operating Systems

This software utility can be used on an NYE IPC with Windows 7 or higher.

Compatibility with related software utilities

When during startup the error **Could not load plugin: *\\OMRON\\Utility*.dll** appears software utilities are not compatible.

Download and install the latest version of the installed software utilities.

3-3-7 Installation

The Industrial PC Support Utility is pre-installed on the Industrial PC if it comes with a Windows operating system installed.

Download the Industrial PC Support Utility from [the OMRON website](#) if reinstallation is required.



Additional Information

A new installation on a Windows 10 PC will require the installation of the .net Framework 3.5 SP1.

The .net Framework software can be downloaded from a Microsoft website.

3-3-8 Startup

The Industrial PC Support Utility can be started from:

- Windows Start Menu
Select **OMRON** and then **Industrial PC Support Utility**.
- Industrial PC Tray Utility
- Windows desktop shortcut



3-3-9 Messages

The Industrial PC Support Utility will use the Industrial PC Tray Utility to display UPS messages.

3-3-10 Logging

There is logging in the Windows event log of the following utilities:

- Industrial PC Support Utility

In the Windows Event Viewer filter for event source *IPCServiceHost* or *OMRON Industrial PC Support Utility*.



Additional Information

Refer to *7-2-3 Windows Event Viewer* on page 7-13 for the logged messages.

3-4 Industrial PC Tray Utility

This section provides an overview of the Industrial PC Tray Utility.

3-4-1 Industrial PC Tray Utility Overview

The Industrial PC Tray Utility is a software utility that provides information about the current state of the Industrial PC, its related devices, and associated software.

When running, the Industrial PC Tray Utility is always present as a status icon (A) in the system tray area (B) of Windows.

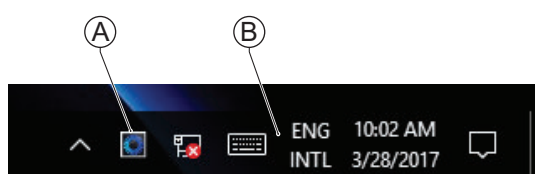

Windows 10

3-4-2 Features

The Industrial PC Tray Utility can display UPS messages. Examples are:

- **Primary power supply failure**
- **Short-circuit detected at output**
- **Temperature is too high**

Example:

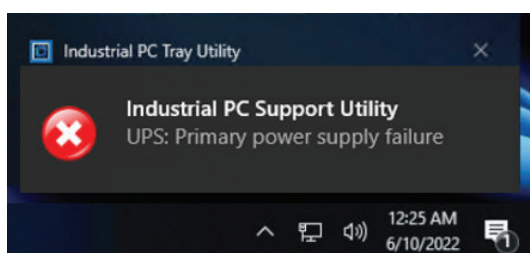

3-4-3 Menu

Select the Industrial PC Tray Utility icon (F) to display the menu.

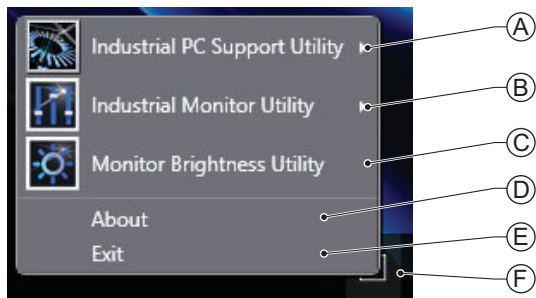

- The application displays the available utilities.
- Select an entry to launch the associated utility, if applicable.
- The icons of menu items in the Industrial PC Tray Utility menu will have a warning or error symbol when applicable.
- The Industrial PC Support Utility (A) is available in the menu when installed.
- The Industrial Monitor Utility (B) is available in the menu when installed.
- The Industrial Monitor Brightness Utility (C) is available in the menu when installed.
- The application area can be configured to show and launch both OMRON and third party utilities.
- The **About** entry (D) shows details of the Industrial PC Tray Utility.
Refer to 3-4-4 *About the Industrial PC Tray Utility* on page 3-16 for details.
- The **Exit** entry (E) closes the utility.

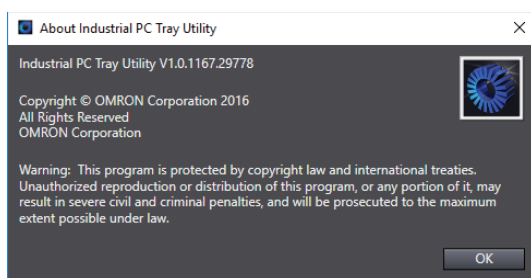

3-4-4 About the Industrial PC Tray Utility

The About window shows the version of the Industrial PC Tray Utility and copyright information.



3-4-5 Status Indicators on Icons

The following table provides the indicator details of the Industrial PC Tray Utility.

Overlay type	Icon	Description
None		No OMRON software utility has issued warning or error notifications.
Warning sign		At least one software utility has issued a warning notification.
Error sign		At least one software utility has issued an error notification.

3-4-6 Compatibility

Compatibility with **Operating Systems**

This software utility can be used on an NYE IPC with Windows 7 or higher.

Compatibility with **related software utilities**

When during startup the error **Could not load plugin: *\\OMRON*\\Utility*.dll** appears software utilities are not compatible.

Download and install the latest version of the installed software utilities.

3-4-7 Installation

The Industrial PC Tray Utility is pre-installed on the Industrial PC if it comes with a Windows operating system installed.

The Industrial PC Tray Utility is included in the installers of the Industrial PC Support Utility and Industrial Monitor Utility. Install the Industrial PC Support Utility or Industrial Monitor Utility to install the Industrial PC Tray Utility.

3-4-8 Startup

By default the Industrial PC Tray Utility is configured to start automatically at Windows startup.

To manually start the Industrial PC Tray Utility:

- 1** Locate the Industrial PC Tray Utility using the Windows **Start** menu or the Windows search box.
- 2** Use the option **Run as administrator** to activate the Industrial PC Tray Utility.



Additional Information

The procedure to use **Run as administrator** is:

- For Windows 10 using the **Start** menu:
Right-click the Industrial PC Tray Utility, select **More** and then **Run as administrator**.
 - For Windows 10 using **Search**:
Right-click the Industrial PC Tray Utility in the search results and select **Run as administrator**.
-

The Industrial PC Tray Utility started.

3-5 Power Attendant Lite Utility

This section provides an overview of the Power Attendant Lite Utility (PAL).

3-5-1 Power Attendant Lite Utility

The Power Attendant Lite Utility is a software utility that constantly monitors the status of the UPS that is connected to the NYE IPC.





When the Power Attendant Lite Utility discovers a power interruption it will send a signal to the NYE IPC to shut down.

Refer to the *UPS Power Attendant Lite for Windows User's Manual* for details.

3-5-2 Features

The Power Attendant Lite Utility provides the following features:

- Signal the NYE IPC to shut down when a power interruption is detected.
- Configure the shutdown conditions when a power interruption is detected.
- Display the state of the connected UPS using the icon in the system tray area.

Icon	Description
	Normal operation
	Power Attendant Lite service stopped
	UPS is supplying power from the internal battery
	Communication error

3-5-3 Compatibility

This software utility can be used on an NYE IPC with Windows 7 or higher.

3-5-4 Installation

The Power Attendant Lite Utility is not pre-installed on a NYE IPC.
Download the installer from [the OMRON website](#) if required.

To install the Power Attendant Lite Utility:

- 1** Ensure the revision number of the UPS is correct.
Refer to the Hardware Manual for details.
- 2** For an Industrial PC Support Utility with tab **UPS Configuration** ensure the setting for **Automatic shutdown** is set to **Use PAL only**.
This will prevent the installation error message **Failed to register the agent service**.
- 3** Ensure the UPS is connected to the NYE IPC with a USB cable.
- 4** Open the Power Attendant Lite Utility installer folder and activate the installer file **setup.exe**.
- 5** Follow the installer steps to complete the installation.

The Power Attendant Lite Utility is installed.

3-5-5 Configuration

Configure the Power Attendant Lite Utility before using the NYE IPC with a UPS connected using USB.

To configure the Power Attendant Lite Utility:

- 1 Activate the icon of the Power Attendant Lite Utility to start the software.



A UPS selection window will be displayed.

- 2 Select the connected UPS.
A Login window will be displayed.

- 3 Login with ID **Admin** and password **omron**.
The Top window with UPS status information will be displayed.

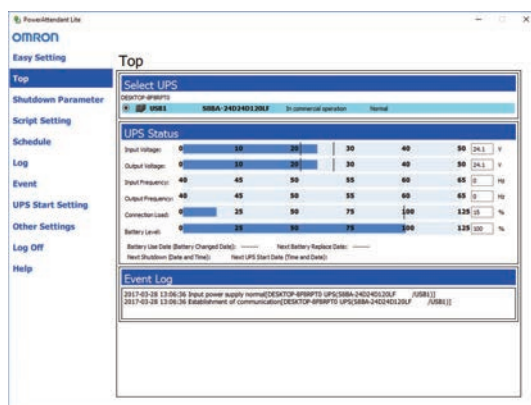

- 4 Configure the parameters for your specific situation.

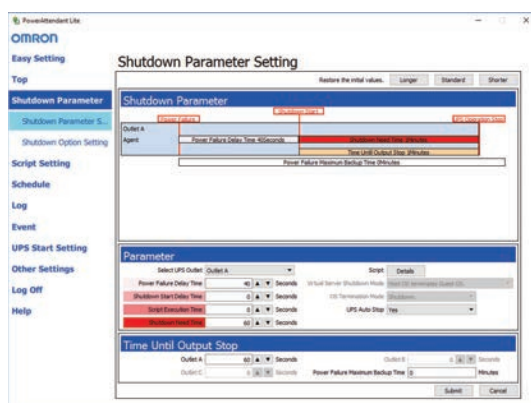

Refer to *UPS Power Attendant Lite for Windows User's Manual* for details.

- 5 Select **Detailed Setting / Other Settings / Communication Setting / UPS Communication Port** to display the parameter **COM search to UPS detection**.
- 6 Set the parameter to **Do not search for COM ports** to prevent interference for the COM ports.

- 7** Select **Submit** to save the setting.
- 8** Select the close button in the right top corner to exit the Power Attendant Lite Utility software.
- 9** Select the restart behavior of the NYE IPC with the BIOS Boot Menu parameter **Power Loss Control**.
Set this parameter to **Turn On** to restart automatically after a power down from the Power Attendant Lite Utility.

10 Test the UPS shutdown behavior.

- 1) Start the NYE IPC
- 2) Start applications
- 3) Create a power interruption
- 4) Monitor the shutdown sequence and confirm a correct shutdown
When the shutdown sequence is not correct change parameters in the Power Attendant Lite Utility software and test the UPS shutdown behavior again.

The Power Attendant Lite Utility is configured.

The NYE IPC will shut down properly in case of a power supply interruption and restart automatically when the power is restored.

3-6 Soft-NA

Soft-NA Software is available for model-ID NYE□□-□□N□□.

Soft-NA Software is not available for model IDs
NYE□□-□□5□□, NYE□□-□□F□□, NYE□□-□□S□□.

Soft-NA Software has it's own manual.
Refer to NA-series Soft-NA User's Manual (V126) for details.

3-6-1 Installation

The Soft-NA Software is not pre-installed. An installer is available at **D:\OMRON-NY\Soft-NA_Installer_v1.2.3** or higher with **Setup.exe**.

Refer to NA-series Soft-NA User's Manual (V126) for installation details.



Additional Information

A license key is not required for the installation of Soft-NA Software.

3-7 NS-Runtime

NS Runtime software is available for model-ID NYE□□-□□S□□.

NS Runtime software is not available for model IDs
NYE□□-□□5□□, NYE□□-□□F□□, NYE□□-□□N□□.

NS-Runtime software has its own manual.

Refer to NS-Runtime Software User's Manual (V093) for details.

Select and download NS-Runtime from [the OMRON website](#) when required.



Additional Information

An internet connection is required to install NS-Runtime.

3-7-1 Installation

The NS-Runtime Software is not pre-installed. An installer is available at **D:\OMRON-NY\Installers
NSRuntime_V1350** or higher with **Setup.exe**.

Refer to NS-Runtime Software User's Manual (V093) for installation details.



Additional Information

- A license key is not required for the installation of NS-Runtime.
 - The installation instruction to remove the dongle can be ignored.
For NS-Runtime on the NYE a dongle is not required.
-

3-8 CX-Designer

CX-Designer is available for model-ID NYE□□-□□S□□.

CX-Designer is not available for model-IDs

NYE□□-□□5□□, NYE□□-□□F□□, NYE□□-□□N□□.

CX-Designer software has its own manual.

Refer to CX-Designer User's Manual (V099) for details.

Select and download CX-Designer from [the OMRON website](#) when required.



Additional Information

An internet connection is required to install CX-Designer.

3-9 COM Port for Host Link

To use Host Link over a serial interface an additional virtual COM port is required. In this section details for the installation and COM port ID of the virtual COM port for Host Link.

3-9-1 Install the Virtual COM Port

To install a Virtual COM Port for Host Link:

- 1** Open an Explorer and browse to **D:\OMRON-NY\Installers\vcp_nsr_1000** or higher.
- 2** Right-click file **Install_driver.cmd** and from the pop-up window select **Run as administrator**. The installer will start and display **Installing driver ...**
- 3** When the installation is finished the messages **Driver installed successfully**, and **Press any key to continue . . .** are displayed.
- 4** Press any key to close the installer.
- 5** Reboot the NYE IPC.
- 6** Determine the assigned COM port number.
Refer to *3-9-2 Determine the COM Port Number for Host Link* on page 3-26 for details.

3-9-2 Determine the COM Port Number for Host Link

To check if the Virtual COM Port is available for Host Link:

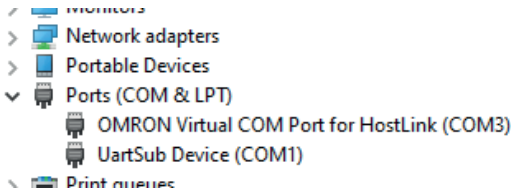
- 1** On the NYE IPC use the Windows search bar to search for **device** and select the match **Device Manager**. The **Device Manager** window will open.
- 2** Browse to **Ports (COM & LPT)** to display the COM ports.
 
- 3** Search for the COM port with the name **Omron Virtual COM Port for Host Link**
 - The assigned COM port number is the COM port number for the Host Link communication.
 - If the name is not available then install the Virtual COM Port.
Refer to *3-9-1 Install the Virtual COM Port* on page 3-26 for details.

The COM Port number for Host Link is known.



Specifications

This section provides specifications of the NYE Industrial PC.

4-1	Software Specifications	4-2
4-1-1	Compatible and Available Operating Systems	4-2

4-1 Software Specifications

This section provides the Software Specifications of the NYE Industrial PC.

4-1-1 Compatible and Available Operating Systems

The operating system installed on the NYE IPC must be:

- compatible with the Advanced Configuration and Power Interface (ACPI) protocol
- installed on the CFast Card

The available and compatible operating system for the NYE IPC is Windows 10.



Additional Information

Install applicable hardware drivers and support software to access all features of the NYE IPC.

- Refer to 5-1 *Install Software* on page 5-2 for details.
- Refer to 5-2 *Install Support Software* on page 5-9 for details.

Supported Languages

Languages default supported by the operating system are:

Operating System	Languages						
	EN	CN*1	DE	ES	FR	IT	JA
Windows 10	✓	✓	✓	✓	✓	✓	✓

*1. CN Simplified (ZH-CN) and CN Traditional (ZH-TW)



Additional Information

Refer to the Microsoft support information for details on available language packs.

5

Installation

This section provides all installation details for the NYE Industrial PC.

5-1	Install Software	5-2
5-1-1	Windows Startup First Time	5-2
5-1-2	Main Application	5-3
5-1-3	Internet Browser	5-4
5-1-4	Firewall	5-4
5-1-5	Anti-virus Software	5-4
5-1-6	Drivers and Custom Software	5-7
5-1-7	Activate Windows	5-7
5-1-8	Customize Windows	5-7
5-1-9	Disable Scheduled Defragmentation	5-8
5-2	Install Support Software	5-9
5-2-1	Overview IPC Support Software for Installation	5-9
5-3	Create Backup and Repair Data of the Installation	5-10

5-1 Install Software

This section describes how to install the software for the NYE Industrial PC.

5-1-1 Windows Startup First Time

Use the following procedure for the first time startup of Windows on your NYE IPC.

This procedure is applicable for NYE□□-□□5□□, NYE□□-□□N□□, NYE□□-□□S□□.

This procedure is not applicable for NYE□□-□□F□□.



Additional Information

Do not power OFF the NYE IPC during this procedure!

At the end of this Out Of Box Experience (OOBE) will result in the Windows home screen.

- 1** Ensure an input device is present.
 - For an Industrial Panel PC touch functionality is available. A keyboard and mouse are not required.
- 2** If a UPS or I/O connector is connected then disconnect it from the NYE IPC.
- 3** Power ON the NYE IPC.
- 4** Follow the windows installation procedure.

Pay special attention to the following steps:

 - Language
 - Select the preferred language in the Language Selection Window
 - Select the language carefully, the selected system language can not be changed.
 - Legal stuff like license agreements
 - Windows 10: Select **Accept** to accept the combined Windows and OMRON license agreements.
 - The **Sign in with Microsoft** Window.
 - Select:
 - Enter your existing Microsoft account when your NYE Industrial PC is connected to a network.
 - Select **Domain join instead** when a local account is preferred.
 - Settings
 - Windows 10: Select **Customize** instead of **Use Express settings**.
 - Set the settings according to your application environment.
 - Create a user account and password and enter the **password hint**



WARNING

Security setting adjustments should only be performed by the engineer in charge that possesses a thorough understanding of the security settings. Selecting non-recommended security settings can put your system at risk.



**Precautions for Safe Use**

- Choose an OS password that is not obvious to prevent unauthorized access.
- Remember the OS user name and password. The product is inaccessible without it.

The NYE IPC will automatically restart.

A black screen will be visible for a few seconds and then the NYE IPC will boot to the Windows start screen.

Recent Windows 10 Operating Systems will automatically perform a Windows Update when the NYE IPC is connected to the internet. This will keep the NYE IPC occupied for a longer period of time, wait until it is completed and the NYE IPC automatically reboots.

- 5 Login.
- 6 Check and if necessary adjust the time and the timezone.
- 7 Adjust the backlight, Logo LED, and Status LED brightness to your settings.

**Additional Information**

Verify that the NYE IPC is responding to finger touches on the touchscreen of the product.

- 8 Reconnect the UPS connector or I/O connector if applicable.
- 9 Install any third party software and drivers that may be required for your applications.

**Precautions for Safe Use**

Before operating the system, please make sure the appropriate software is installed and configured. Doing so may prevent unexpected operation.

5-1-2 Main Application

Depending on the NYE Model ID the main application has to be installed.

Model ID	Main Application	Installation
NYE□□-□□5□□	-	-
NYE□□-□□N□□	Soft-NA Software	Refer to 3-6 <i>Soft-NA</i> on page 3-23 for details.
NYE□□-□□S□□	NS-Runtime Software	Refer to 3-7 <i>NS-Runtime</i> on page 3-24 for details.
	CX-Designer	Refer to 3-8 <i>CX-Designer</i> on page 3-25 for details.

5-1-3 Internet Browser

Depending on the operating system an Internet Browser is preinstalled.



Additional Information

- Check the IT policy of your company for available software and for details on the software environment the NYE Industrial PC will operate in.
- Install all updates and ensure the browser stays up-to-date.

Browser Windows 10

For Windows 10 the standard Internet Browser is installed.

5-1-4 Firewall

An industrial network should be separated from an office network.

Depending on the operating system a Firewall is preinstalled.

- For Windows 10 the standard firewall software is installed and enabled.



Precautions for Safe Use

- Separate the machine network segment from the office network to avoid communication failures.
- Install all updates and ensure the firewall stays up-to-date.



Additional Information

Check the IT policy of your company for available software and for details on the software environment the NYE Industrial PC will operate in.

5-1-5 Anti-virus Software

The Windows operating system is vulnerable for viruses. Anti-virus software should be installed on the Windows operating system.

Depending on the operating system Anti-virus software is preinstalled.

- For Windows 10 the standard Anti-virus software is installed and enabled.



Additional Information

Check the IT policy of your company for available software and for details on the software environment the NYE Industrial PC will operate in.



Precautions for Safe Use

- Make sure that your operating system environment is protected against malicious software and viruses.
- Install all updates and ensure virus definitions stay up-to-date.

Update Windows Defender - Offline

To protect your NYE IPC the Windows Defender virus definitions should always be up to date. This procedure describes how to update the Windows Defender virus definition files for a NYE IPC that is not connected to the internet.

Use the following procedure to update the virus definition files:

- 1 Use a PC with an internet connection and visit website <https://www.microsoft.com/en-us/wdsi/defenderupdates>
- 2 Browse to the section **Manually download the update** and select the Definition version for your NYE IPC
It will be downloaded to the PC.
- 3 Move the downloaded file to the NYE IPC.
- 4 On the NYE IPC use the Windows search bar to search for **command** and select the match **Command prompt**

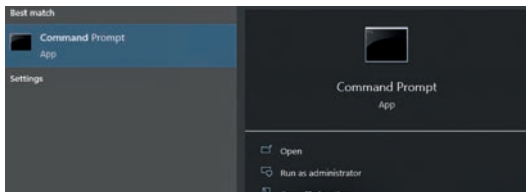

The **Command prompt** window will open.

- 5 Use dos-commands followed by **Enter** to activate the transferred virus definitions file. Example for the file **mpam-fe.exe** that is placed in **d:\WindowsUpdate\UpdateFiles**:
 - d:
 - cd d:\WindowsUpdate\UpdateFiles
 - mpam-fe.exe

 A screenshot of a Windows Command Prompt window. The title bar reads 'Command Prompt'. The window content shows the following text:

```
Microsoft Windows [Version 10.0.17763.2237]
(c) 2018 Microsoft Corporation. All rights reserved.
C:\Users\Omron>D:
D:\>cd d:\WindowsUpdate\UpdateFiles
d:\WindowsUpdate\UpdateFiles>mpam-fe.exe
d:\WindowsUpdate\UpdateFiles>
```

The update is finished when a new line without the last command appeared. Use dos command **Exit** to close the command prompt window.

- 6 Use the Windows search bar to search for **protection**. Select the match **Virus & threat protection**. The **Virus & threat protection** window will open.

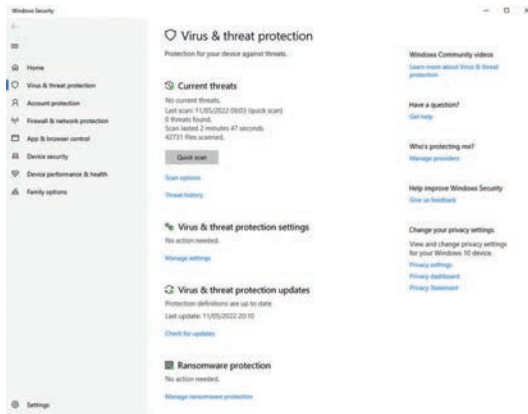
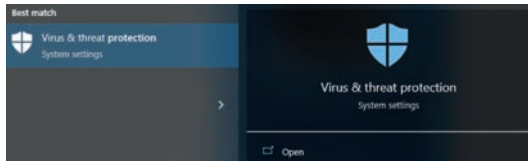

7 Check the status to ensure the virus definitions are up to date.

The virus definitions are up to date.

5-1-6 Drivers and Custom Software

Use the following procedure to install drivers and custom software on your NYE Industrial PC.

- For an IPC without Operating System download the drivers from [the OMRON website](#).
- For an Industrial PC with a Windows operating system the drivers for most OMRON devices and common third party devices are already available on the product. They will be installed automatically after the initial Windows configuration or upon connection of a device to the NYE IPC. Download the drivers from [the OMRON website](#) if reinstallation is required.

- 1** Install drivers that are required for the application.
- 2** Install third-party software that is required for the application.
Follow the installation instructions as supplied with the driver or software.



Precautions for Safe Use

Before operating the system, please make sure the appropriate software is installed and configured. Doing so may prevent unexpected operation.

5-1-7 Activate Windows

To activate Windows an internet connection is required.

If an internet connection is not available during the installation process then the Windows license will only be active after an internet connection has been established.

Activation is not required, a non-activated version of Windows is fully functional.

Refer to the Hardware Manual for the location of the Windows product key.

5-1-8 Customize Windows

Set the regional settings to your preferences.

Windows provides customization tools.

Using these tools is only allowed for experienced software engineers.



Additional Information

- For Windows 10:
 - Refer to *A-1-1 Unified Write Filter* on page A-2 for UWF details.
 - Refer to *A-1-2 Trusted Platform Module* on page A-3 for TPM details.
-

5-1-9 Disable Scheduled Defragmentation

Use the following procedure to prevent an unexpected performance decrease caused by scheduled defragmentation.

- 1 On the NYE IPC use the Windows search bar to search for **task scheduler** and select the match **Task Scheduler**
- 2 The **Task Scheduler** window will open.

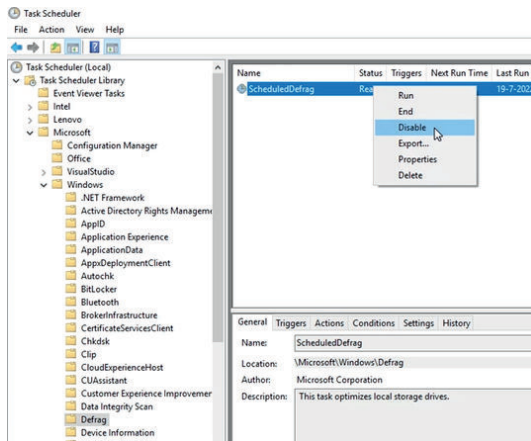

- 3 Browse to **Microsoft / Windows / Defrag** to display the name **ScheduledDefrag**
- 4 Right click the name.
A submenu will appear.
- 5 Select **Disable** to change status to Disabled.
- 6 Close the Task Scheduler.

Scheduled defragmentation is disabled.

5-2 Install Support Software

This section describes how to install the support software for the NYE Industrial PC.

5-2-1 Overview IPC Support Software for Installation

This section gives an overview of the IPC support software available for your NYE Industrial PC.

Software Utilities

The applicable software utilities are already installed on the CFast Card. Refer to the details in the table to find installation details.

The software utilities can be downloaded from [the OMRON website](#).



Additional Information

An internet connection is required to install support software.

Product	Details
Industrial PC Support Utility	Refer to 3-3-7 <i>Installation</i> on page 3-13 for details.
Microsoft .NET Framework 4.6	Comes with the Industrial PC Tray Utility.

5-3 Create Backup and Repair Data of the Installation

Ensure the operating system, software and data can always be restored when required. There are different software tools to create a backup and repair data. Select the Backup and Repair procedure or procedures that are most suitable for your situation.



Precautions for Correct Use

Refer to *7-1-3 Overview of Recover, Restore and Repair Methods for NYE* on page 7-3 for details.



Operating Procedures

This section provides the operating procedures for the NYE Industrial PC.

6-1	React to Product Messages	6-2
6-2	React to Windows Messages	6-3

6-1 React to Product Messages

The NYE Industrial PC uses the Industrial PC Tray Utility icon (A) in the system tray area (B) of Windows to present Warnings and Errors.

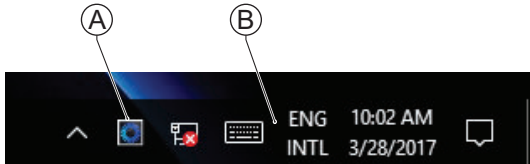

Check the Industrial PC Tray Utility icon for a Warning or Error symbol. A Warning or Error symbol displayed on the Industrial PC Tray Utility icon indicates a product message.

To react to a product message:

- 1** Select the Industrial PC Tray Utility icon. A pop-up window will appear.
- 2** Read the message available in the pop-up.
- 3** Refer to *7-2-1 Warning and Error Messages* on page 7-10 for all details on the message. Perform the actions presented for the message until the Warning or Error is resolved.

The product messages for the NYE Industrial PC are resolved.

6-2 React to Windows Messages

Windows uses the Windows Action Center icon (A) in the system tray area (B) of Windows to present Warnings and Errors.

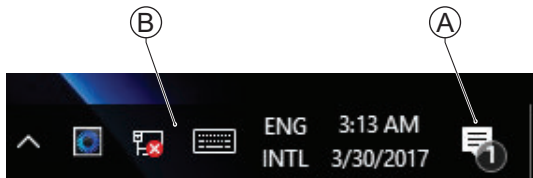

Windows 10

Check the Windows Action Center icon for a Warning or Error symbol.

A Warning or Error symbol displayed on the Windows Action Center icon indicates a Windows message.

To react to a Windows message:

- 1** Open the Windows Action Center.
 - For Windows 10: Click the Windows Action Center icon. A pop-up window will appear.
- 2** Read the message available in the window.
- 3** Perform the actions until each Warning or Error is resolved.

The Windows messages for the NYE Industrial PC are resolved.



Maintenance

This section provides an overview of the software maintenance tasks for the NYE Industrial PC.

The hardware maintenance tasks are available in the hardware manuals.

Information is available in the related manual *NY-series NYE Industrial Panel PC Hardware User's Manual (Cat.No. W634)*.

7-1	Preventive Maintenance	7-2
7-1-1	Preventive Maintenance Schedule	7-2
7-1-2	Keep Software Updated	7-2
7-1-3	Overview of Recover, Restore and Repair Methods for NYE.....	7-3
7-2	Corrective Maintenance.....	7-10
7-2-1	Warning and Error Messages.....	7-10
7-2-2	Allocate a Drive in Windows.....	7-12
7-2-3	Windows Event Viewer.....	7-13
7-2-4	Windows Low on Memory	7-15
7-2-5	Windows Blue Screens	7-16
7-2-6	Correct Display Functionality when Nothing is Displayed	7-16
7-2-7	Correct Touchscreen Functionality	7-17
7-2-8	Restore a Custom Backup with Windows	7-18

7-1 Preventive Maintenance

Preventive Maintenance covers all actions that prevent downtime.

7-1-1 Preventive Maintenance Schedule

Prevent unscheduled downtime with the following preventive maintenance schedule.

Daily	Reference
Check NYE Industrial PC status	Refer to <i>7-2-1 Warning and Error Messages</i> on page 7-10 for all available messages.
Weekly	Reference
Ensure you have the latest software updates	Refer to <i>7-1-2 Keep Software Updated</i> on page 7-2 for update details.
When changing applications or configurations	Reference
Create a backup of the NYE Industrial PC	Refer to <i>7-1-3 Overview of Recover, Restore and Repair Methods for NYE</i> on page 7-3 for details.
Periodically but at least every 6 months	Reference
Check the status of backup storage devices.	Refer to <i>Check the Custom Backup Storage Device (Windows)</i> on page 7-6 for details.

7-1-2 Keep Software Updated

Always keep software at the latest released version to ensure stable operation.

This is specifically important for:

- Anti-virus software
- Firewall software
- Internet browser
- Windows security patches
- OMRON software



Precautions for Correct Use

After an OS update or a peripheral device driver update for the product is executed, the product behavior might be different. Confirm that operation is correct before you start actual operation.



Additional Information

- Refer to Internet Browser for Browser details.
- Refer to *5-1-4 Firewall* on page 5-4 for Firewall details.
- Refer to *5-1-5 Anti-virus Software* on page 5-4 for Anti-virus details.

7-1-3 Overview of Recover, Restore and Repair Methods for NYE

Depending on the goal and depending on the available backup and repair data an applicable backup and recover, restore or repair action can be selected.

An overview of the different methods to restore and repair Windows and custom files:

Tool	Goal	Preparation in advance	Restore details	Refer to
Windows Backup and Restore	Restore a user's selection of folders	Create a Windows Backup	<ul style="list-style-type: none"> The data is restored to the state of the previously created backup Recovery of specific folders is possible. Backups can be created automatically at predefined intervals No recovery of the Windows operating system Uses any type of storage device 	<p>Create: <i>Create a Custom Backup with Windows Backup</i> on page 7-4</p> <p>Check: <i>Check the Custom Backup Storage Device (Windows)</i> on page 7-6</p> <p>Restore: <i>7-2-8 Restore a Custom Backup with Windows</i> on page 7-18</p>
Windows 10 Recovery Drive	Recover Windows 10 to a previous state	Create a Windows Recovery disk	<ul style="list-style-type: none"> A partial recovery or recovery of user data is not possible Windows recovers to the state of the previously created Recovery image Uses a USB storage device The IPC can boot with this USB 	<p>Create: <i>Create a Windows 10 Recovery Drive</i> on page 7-7</p> <p>Recover: <i>Recover Windows 10 with the Recovery Drive</i> on page 7-21</p>
Rescuezilla	Recover a disk to a previous state	Create a disk image	<ul style="list-style-type: none"> Disk image Uses a USB storage device The IPC can boot with this USB 	<p>Create: <i>Create a Disk Image with Rescuezilla</i> on page 7-9</p> <p>Recover: <i>Recover a Disk Image with Rescuezilla</i> on page 7-22</p>



Additional Information

Contact your OMRON representative when the NYE IPC needs to be restored and you do not have any restore or recover possibility.

Create a Custom Backup with Windows Backup

Use the following procedure to create a custom backup of the NYE Industrial PC with the Windows Backup and Restore mechanism.

To manually or automatically create a customized backup:

- 1 Select the Windows **Start** Button.
- 2 In search field, input *Backup settings*.
- 3 Select **Backup settings**.
The Backup window opens.
- 4 If available select the option **Go to Backup and Restore (Windows 7)**.
The **Backup and Restore (Windows 7)** window is now visible.

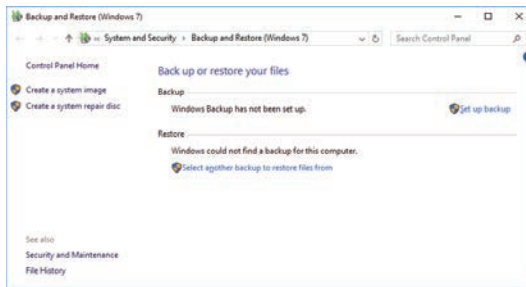

- 5 Select **Set up backup**.
The Set up backup window opens.

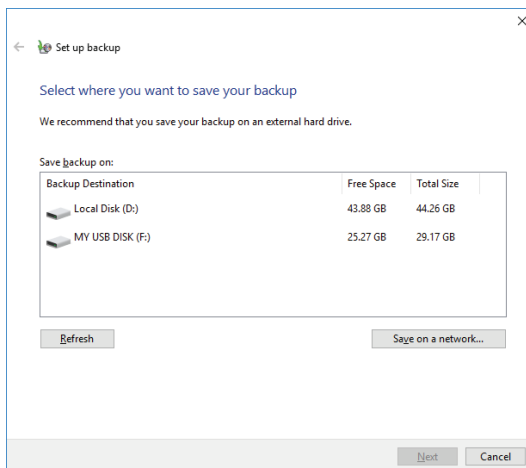

- 6 Select the backup destination.
A network location can be added with **Save on a network**.



Additional Information

Preferred locations for an automatic backup are:

- A network drive
- The local drive in drive bay B, when installed.

7 Select **Next**.

The following window will appear:

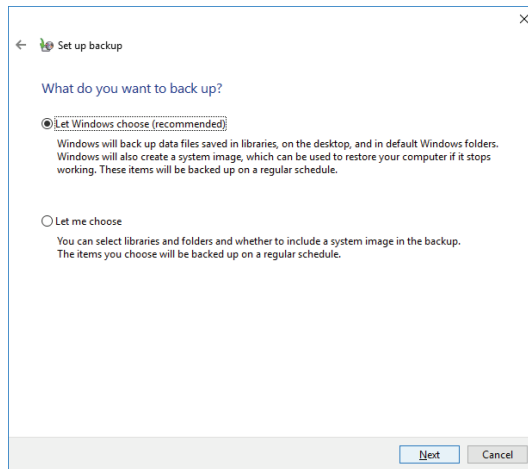
**8** Select **Let me choose** and then select **Next**.

The following window will appear:

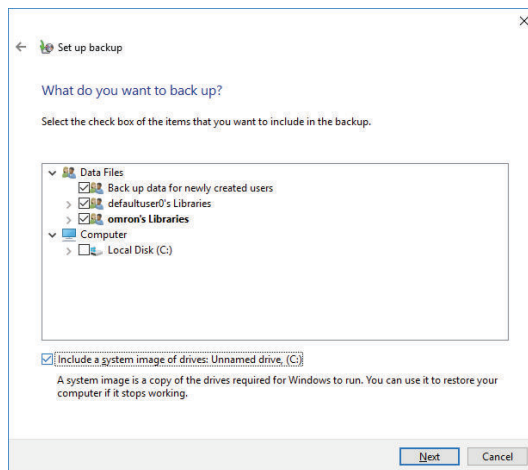
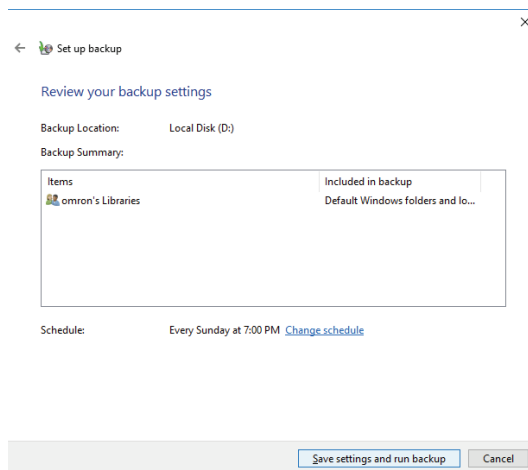
**9** Select all directories you want to include in the backup.**10** Select **Next**.

11 Select **Configure schedule** or **Change schedule** and change the backup schedule.

Ensure:

- The interval is short enough to minimize data loss when a restore is required
- The NYE Industrial PC is powered ON during the backup periods
- The time the backup is scheduled does not interfere with normal operation or uncheck **Run backup on a schedule** if an automatic backup is not possible.

12 Select **OK**.

13 Select **Save settings and run backup** to create the first backup.



Precautions for Correct Use

Create backups according to the preventive maintenance schedule to prevent data loss and system integrity issues.

Refer to *7-1-1 Preventive Maintenance Schedule* on page 7-2 for intervals.



Additional Information

- Check your backup to ensure it contains all data required for a restore.
 - Refer to <http://windows.microsoft.com/> for Backup and Restore details.
 - Refer to *7-2-8 Restore a Custom Backup with Windows* on page 7-18 for the Restore Procedure.
-

● **Check the Custom Backup Storage Device (Windows)**

Use the following procedure to check the custom backup storage device.

1 Insert the storage device with the backup in the NYE Industrial PC that created the backup.

2 Follow the first few steps of the restore procedure to display the 'Restore files' screen.
Refer to *7-2-8 Restore a Custom Backup with Windows* on page 7-18 for details.

3 Browse the storage device and ensure at least one backup is displayed.

4 Select **Cancel** to cancel the restore procedure.

The storage device with the custom backup is approved.

Create a Windows 10 Recovery Drive

A Windows recovery drive can repair Windows if a serious error occurs.

Prepare:

- A USB storage device that has sufficient capacity to backup the content of the NYE IPC. The capacity should be at least the Windows partition size + 16 GB. The recommended minimum read/write speed is 190 MB/s.

Note that all content on this USB storage device will be erased.

Use the following procedure to create a Windows recovery drive:

- 1** Insert the USB storage device in a USB 3.0 connector.
- 2** Select the Windows **Start** Button.
- 3** In the search field, input *recovery drive*.
- 4** Select **Create a recovery drive**.
The recovery drive window opens.

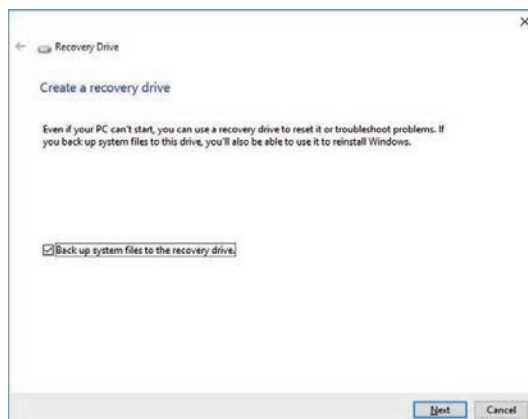

- 5** Check the checkbox **Back up system files to the recovery drive** and then select **Next**.
The drive selection window opens.

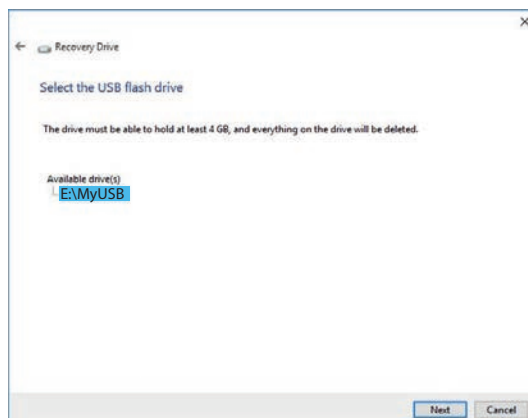

- 6** Select the applicable drive letter and then select **Next**.
The Create window will appear.

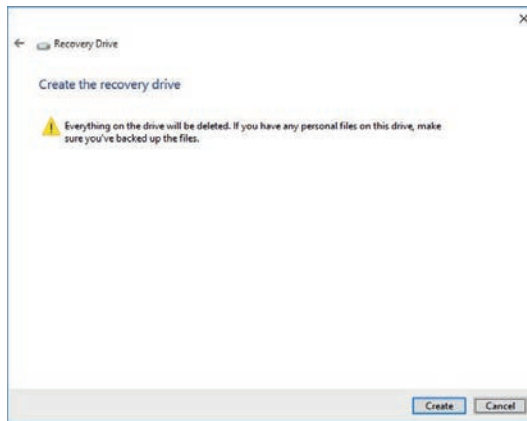

7 Read the warning and if your personal files are safe then select **Create**.

8 Wait until the progress bar is finished and the message **The recovery drive is ready** appears.

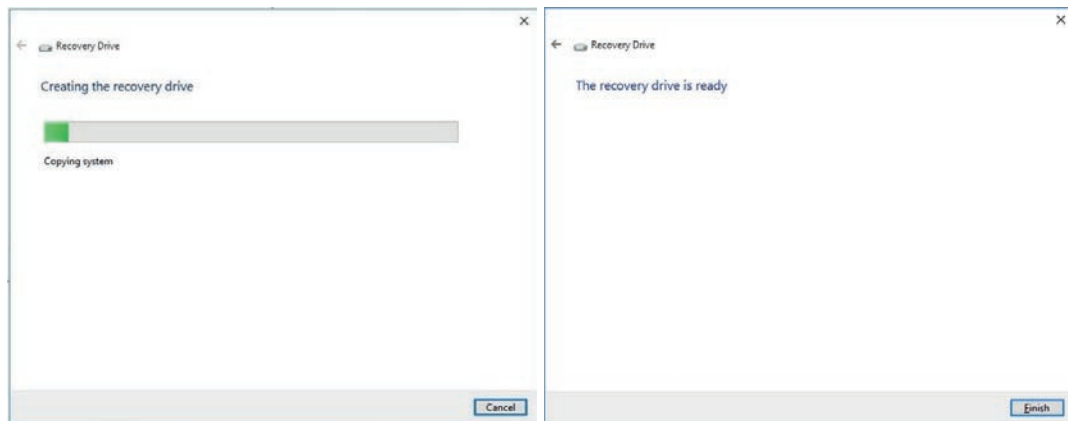

9 Remove the USB storage device and store it in a safe place.

The Windows recovery drive is ready.



Additional Information

Refer to <http://windows.microsoft.com/> for recovery drive details.

Create a Disk Image with Rescuezilla

With Rescuezilla a disk image can be created.

A disk image can contain more than one partition.



Precautions for Correct Use

A Rescuezilla disk image can be used to recover a disk of the NYE IPC. It can also restore data to another NYE IPC if the product configuration is identical to the NYE IPC that created the disk image.



Additional Information

- Use two USB devices: 1 for Rescuezilla and 1 for the disk image.
- Use a USB 3 device for the disk image to reduce the time required creating the disk image.

To create a disk image with Rescuezilla:

- 1 Download **Rescuezilla** from <https://rescuezilla.com>.
- 2 Write the image to a bootable USB device.
Ensure the USB device is bootable.
The rescuezilla download page mentions a program such as **balenaEtcher** but feel free to use your preferred tooling e.g. **Rufus** (<https://rufus.ie/en/>) to make the USB device bootable.
- 3 Power OFF the NYE IPC.
- 4 Insert the bootable USB device with Rescuezilla.
- 5 Power ON the NYE IPC and press the F11 key repeatedly directly after Power ON to display the Boot Selection Popup menu.
- 6 In the Boot Selection menu select USB as boot device.
Rescuezilla will start.



- 7 Select **Backup** and follow the steps to create a disk image.

A disk image is created.

7-2 Corrective Maintenance

Corrective maintenance covers all actions to correct problems that cause downtime.

 **WARNING**

Do not attempt to disassemble, repair or modify the product in any way. Doing so may result in malfunction or fire.



Contact your local OMRON representative if the corrective maintenance actions did not solve the problem.

7-2-1 Warning and Error Messages

Warning and Error messages are provided by the NYE Industrial PC when there is a potential problem that may cause downtime. This section provides details about these messages.

Warning messages inform you about a situation that will lead to downtime of the NYE Industrial PC. Error messages inform you about what caused the downtime of the NYE Industrial PC.

The following message channels are available.

LED Indicators

The ERR LED indicator provides information on warnings and errors.

Industrial PC Support Utility

The Industrial PC Support Utility provides information on warnings and errors. The Industrial PC Support Utility indicates the status of the UPS.

Windows Action Center

The Windows Action Center provides information on Windows related warnings and errors.

The Windows Action Center indicates security and maintenance issues.

Some examples:

- Virus protection (Important)
Windows did not find anti-virus software on this computer.
- Windows Update (Important)
Windows Update is not set up for this computer.
- Set up backup
Your files are not being backed up.

Windows Pop Up Window

Windows Pop Up windows provide information on Windows issues.

An example of a Windows Pop Up

- Close programs to prevent information loss.



To solve this change the paging file size.

7-2-2 Allocate a Drive in Windows

An added drive must be allocated before it becomes visible in Windows.

To allocate a drive in Windows:

- 1** Ensure the NYE IPC is ON.
- 2** Select the Windows **Start** Button.
- 3** In the search field, input *partition*.
- 4** Select **Create and format hard disk partitions**.
The Disk Management window opens. The new disk is displayed with a storage space **Unallocated**.
- 5** Right-click on the unallocated space and select **New Simple Volume**.
The New Simple Volume Wizard opens.
- 6** Follow the steps in the New Simple Volume Wizard.

The drive is installed and ready for use in Windows under the configured drive letter.



Additional Information

Do not format, resize or change settings for partition C:. Windows is installed on drive partition C: and any change to this partition can cause Windows to stop working.

7-2-3 Windows Event Viewer

The Windows Event Viewer displays logged events.
These logged events can support you in corrective maintenance.

- 1 Select the Windows **Start** Button.
- 2 In the search field, input *Event*.
- 3 Select **View event logs**.
The Event Viewer opens.

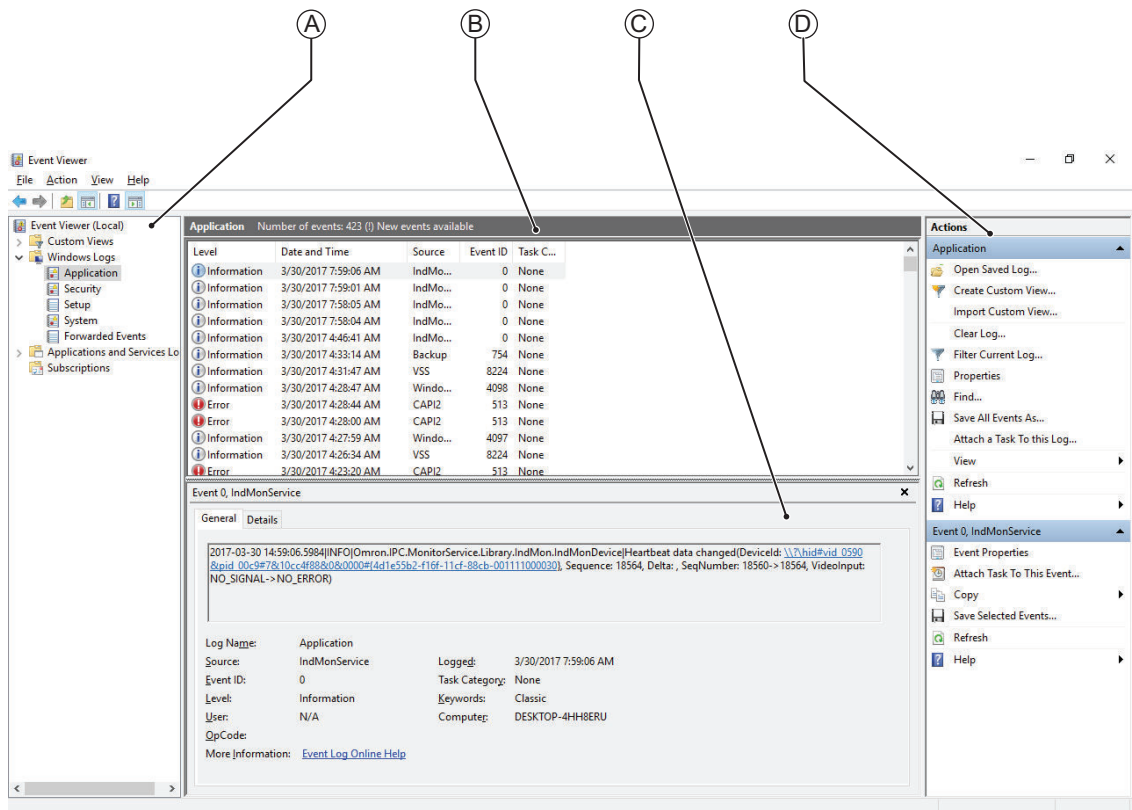

Item	
A	Selection tree
B	Event list
C	Event details
D	Action list

- 4 In the Selection tree expand **Windows Logs** and select **Application**.
The Event list will display the Events.
- 5 Select the heading **Source** to sort the event messages per application.
- 6 Scroll to the event you want to investigate.
Refer to the section 'Logging' of a specific utility for more details.

- 7 Select the event to display details in the Event details window or to take action in the Action overview window.

Filter Events and Event Details

This procedure explains how to filter events in the Windows event log.

To filter the events:

- 1 Open the Windows Event Viewer.
Refer to *7-2-3 Windows Event Viewer* on page 7-13 for details.
- 2 In the *Actions list* select *Filter Current Log*.
The Filter Current Log page opens.

- 3 Input the desired filters and select **OK**.
- 4 The filtered events will appear in Event list of the Event Viewer.
Select an event in the Event list to display Event details in the Event details part of the Event Viewer.

The filtered events are available including the details per event.

7-2-4 Windows Low on Memory

The Windows memory can become low when adding applications and/or updates.

When the memory is low a new window with the message *Close programs to prevent information loss* will appear.

Increase the paging file size to solve this problem.

To increase the page file size:

- 1 Select the Windows **Start** Button.
- 2 In the search field, input *advanced system settings*.
- 3 Select **View advanced system settings**.
The Advanced tab page in the Windows System properties will appear.
- 4 In the group **Performance**, select the **Settings...** Button.
The Performance options window will appear.
- 5 Select the **Advanced** tab page.
- 6 In the group **Virtual memory**, select the **Change...** Button.
- 7 Select the checkbox **Automatically manage paging file size for all drives**.

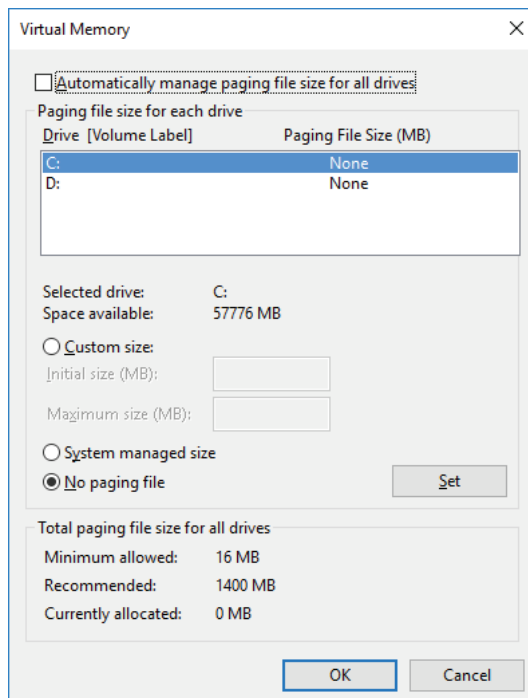

- 8 Select the **OK** Button to save this setting.



Precautions for Safe Use

Virtual memory settings can affect the performance of the system. Disable the paging file after installation of applications or updates.

7-2-5 Windows Blue Screens

A blue screen will appear if Windows crashes.

Possible solutions for repetitive blue screens:

- 1** Install the latest updates of Windows.
- 2** Install the latest device drivers.
- 3** If changes to the system were made: Undo recent hardware changes, undo recent driver updates and then roll back system to latest working state.



Additional Information

- Windows 10: Refer to <https://support.microsoft.com/en-us/help/14238/windows-10-troubleshoot-blue-screen-errors> for details.
- For troubleshooting an external boot device might be handy.

7-2-6 Correct Display Functionality when Nothing is Displayed

When it seems the display is not functional, check the ERR LED.

- If the ERR LED is OFF
 - Check if the power supply is present.
- If the ERR LED is blinking check if the NYE IPC is not in standby mode.
- If the ERR LED is ON
 - Check if the power supply voltage is inside specifications.
 - Check if the ambient temperature is inside specifications.

7-2-7 Correct Touchscreen Functionality

The touchscreen functionality can have several unwanted situations. In this section more details and solutions for touchscreen problems.

Correct Touchscreen Functionality with No Touch Response

When the touchscreen functionality is not functional, check:

- Water present on the display surface.
Wipe the display surface with a dry lint free cloth.
- When using gloves, ensure to use gloves that had no problems when the touch functionality was functional.

Calibrate Touchscreen

When the resolution of the touchscreen monitor is changed the touch functionality might not scale accordingly. The result is that touching the touchscreen monitor will display the touch at incorrect locations.

Use the following procedure to calibrate the touchscreen functionality of your NYE Industrial PC.

- 1** Select an Explorer and browse to **C:\Omron\Drivers\FID-1890-029_1013**.
- 2** Activate *Calwin.exe*.
A white screen will appear with a cross as a touch indicator indicating where to touch the screen.
- 3** Touch the indicator on all locations where it appears.
After several touches a pop-up window will appear.
- 4** Select the **Update** Button.
- 5** Check the touchscreen functionality.

The touchscreen functionality is calibrated.

7-2-8 Restore a Custom Backup with Windows

Use the following procedure to restore a custom backup of user files with Windows Backup and Restore.



Additional Information

- Refer to *Create a Custom Backup with Windows Backup* on page 7-4 for Custom Backup details.

Ensure:

- The NYE Industrial PC is ON
- You are logged in
- A backup is created earlier and it is available

To restore a backup:

- 1** Select the Windows **Start** Button.
- 2** In the search field, input *Backup*.
- 3** Select **Backup and Restore**.

The Backup and Restore window opens.

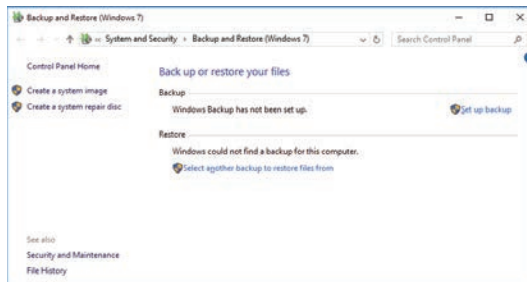

- 4** Select **Restore my files**.
The restore files window opens.

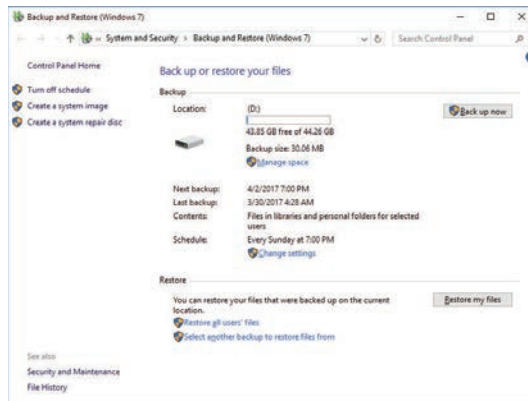

- 5** Use the buttons **Search** and **Browse for files** or **Browse for folders** to find the created back-up.

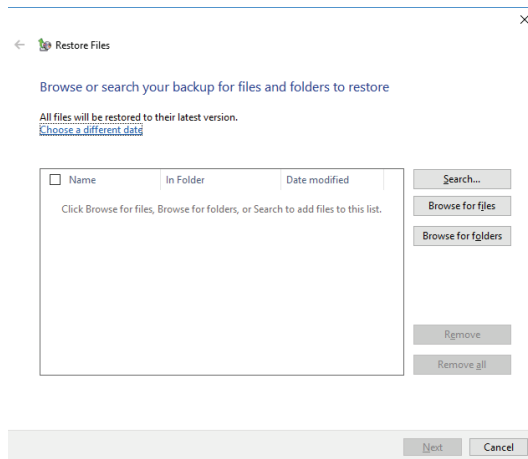

- 6** Add the files and folders to be restored and then select **Next**.



Additional Information

With this Windows Restore procedure it is not possible to restore files that are in use. This means system files and files of the logged in user can not be restored with this procedure.

- 7** Select **In the original location** and then select **Next**.
The progress window will appear.

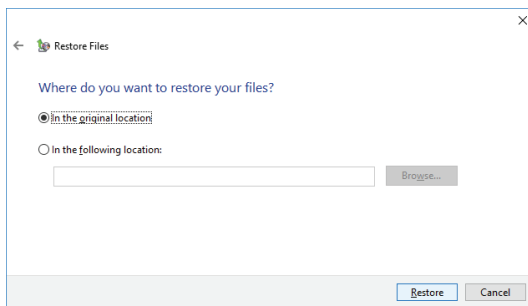

- 8** Wait until the message **Your files have been restored** appears and then select **Finish**.

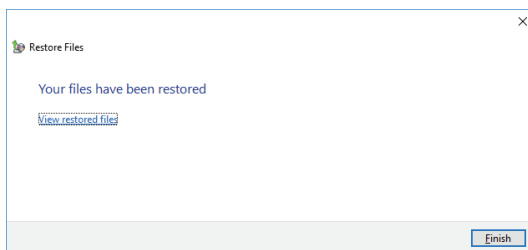

The files are restored.

Recover Windows 10 with the Recovery Drive

Use the following procedure to recover Windows 10 to a previous state using a Recovery Drive.

Ensure a Windows Recovery Drive is created earlier and it is available:

To recover Windows 10:

- 1** Connect the USB storage device to the NYE IPC.
- 2** Power ON the NYE IPC and press **F11** repeatedly to display the Boot Selection Popup menu.
- 3** Select your boot device and then select **Enter**.
The NYE IPC will reboot.
- 4** When requested choose your keyboard layout.
The window *Choose an option* will appear.

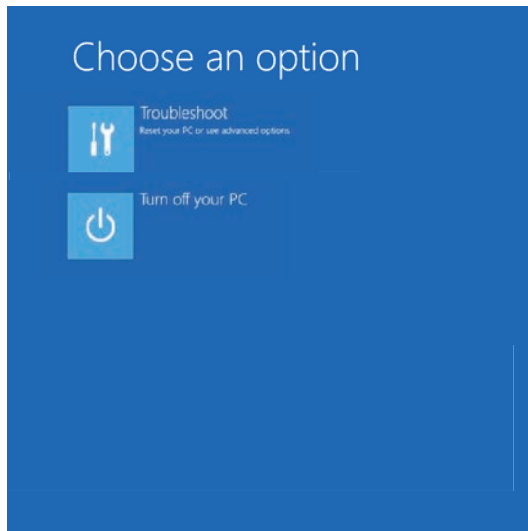

- 5** Select **Troubleshoot**
The window *Troubleshoot* will appear.
- 6** Select **Recover from a drive**.



Additional Information

Windows will be restored to the state the recovery disk was created!

Follow the instruction and wait while Windows 10 reinstalls.

Windows 10 is restored.

Recover a Disk Image with Rescuezilla

With Rescuezilla a disk image can be recovered.
A disk image can contain more than one partition.



Precautions for Correct Use

A Rescuezilla disk image can be used to recover a disk of the NYE IPC. It can also restore data to another NYE IPC if the product configuration is identical to the NYE IPC that created the disk image.

To recover a disk using a disk image with Rescuezilla:

- 1** Power OFF the NYE IPC.
- 2** Insert the USB device with Rescuezilla and the disk Image.
Refer to *Create a Disk Image with Rescuezilla* on page 7-9 for details.
- 3** Power ON the NYE IPC and press the F11 key repeatedly directly after Power ON to display the Boot Selection Popup menu.
- 4** In the Boot Selection menu select USB as boot device.
Rescuezilla will start.



- 5** Select **Restore** and follow the steps to restore the disk.

The disk is recovered.



Appendices

A-1	Customize Windows	A-2
A-1-1	Unified Write Filter	A-2
A-1-2	Trusted Platform Module	A-3

A-1 Customize Windows

This section provides an overview of the tools to customize Windows.

A-1-1 Unified Write Filter

The Unified Write Filter (UWF) is applicable to NYE IPCs with a Windows 10 operating system. The UWF intercepts disk changes and stores them into a memory overlay in RAM memory instead of applying them to the original volume.



Additional Information

- Refer to *Advantages* on page A-2 for details.
 - Refer to *Considerations* on page A-2 for details.
 - Refer to [the Microsoft Developer Network \(MSDN\)](#) for details.
-

Advantages

EWF and FBWF and UWF provide the following benefits:

- Write-protect one or more partitions on a system.
- Make it possible to revert changes and revert to the original disk content.
- Enable booting from read-only media.

By redirecting all write requests to RAM the run-time maintains the appearance of a writable run-time image.

- Improve the file system performance when using relatively slow storage.
- Minimize write actions to the disk.

For example, minimize write access to flash memory. Write cycles on flash memory are limited for technical reasons.

Considerations

When using the Unified Write Filter (UWF) all disk changes are stored into a memory overlay in RAM memory instead of applying them to the original volume. This also applies to the installation of software or changing parameters. For software changes, like Windows updates or system parameter changes, it is required to disable the UWF, install the software and then enable the UWF again.

Using the UWF the following issues need careful consideration:

- To prevent data loss in the event of a power failure, the use of a UPS is recommended.
- When the UWF function is enabled and a large amount of data is written, the system memory space will be reduced and operation may become unstable. To prevent this problem, it is recommended that a large amount of data be written to a different location.
- Automatic Adjustment of daylight saving time (DST) is incompatible with the UWF enabled.

Configuration

The Unified Write Filter (UWF) is included in the Windows 10 image.

The configuration of this component can be defined with the command line tool `uwfmgr.EXE`.

To run the UWF Manager, open the Command Prompt with Administrator rights.

Command	Function	Remarks
<code>uwfmgr.exe get-config</code>	Shows an overview with current status	Use this command to check the status after another command is executed
<code>uwfmgr.exe filter</code>	Configures basic UWF settings	- - -
<code>uwfmgr.exe enable</code>	Enables the unified write filter	This change is not effective until the system is restarted
<code>uwfmgr.exe disable</code>	Disables the unified write filter	This change is not effective until the system is restarted
<code>uwfmgr.exe volume protect C:</code>	Enables the unified write filter for the C: drive	- - -
<code>uwfmgr.exe file commit</code> <code>C:\temp\test1.txt</code>	Issues a commit for a new file with the name C:\temp\test1.txt	Committing the overlay can affect the speed of the boot process
<code>uwfmgr.exe help</code>	Displays a helpscreen that explains all commands and options available	A complete reference can also be found at the Microsoft Developer Network (MSDN)

A-1-2 Trusted Platform Module

The Trusted Platform Module (TPM) integrates encryption keys into the NYE Industrial PC in order to secure hardware and software. The TPM enables the following security functions:

- Ensure the integrity of the platform: The TPM can be used in the BIOS and other software to protect against unauthorized manipulation.
- Disk encryption: The TPM can be used with "BitLocker" drive encryption.
- Password protection and other uses of encryption: The TPM provides encryption key management.



Additional Information

Refer to [the Microsoft Developer Network \(MSDN\)](#) for best practice information.

Usage

To enable the TPM, see the relevant section in the BIOS Settings.

To use the TPM with "BitLocker" drive encryption, please follow the instructions in the operating system.

Considerations

Risk of data loss: If you lose the password for the drive encryption, you will not be able to restore the data. You will then lose access to the encrypted drive. Please store the password carefully and make sure it is protected against unauthorized access.



Index



Index

- A**
- Anti-virus software 5-4
- B**
- Backup 5-10, 7-4
 - Blue screen 7-16
 - Browser 5-4
- C**
- Configuration 1-5
 - Corrective maintenance 7-10
- D**
- Drive
 - Install in Windows 7-12
 - Drivers 5-7
- E**
- Event viewer..... 7-13
 - Filter events 7-14
- F**
- Firewall 5-4
- H**
- HostLink..... 3-26
- I**
- Industrial PC Support Utility 3-6
 - Product information 3-7
 - System status 3-8
 - UPS Configuration 3-12
 - UPS Status 3-9
 - Industrial PC Tray Utility 3-15
- L**
- Languages 4-2
 - Logging
 - Event viewer 7-13
 - Messages 3-14
 - Low on memory 7-15
- M**
- Messages
 - Error 7-10
 - Product 6-2
 - Warning 7-10
 - Windows 6-3
 - Model-ID 1-5
- O**
- Operating system
 - Windows..... 3-3
- P**
- Power Attendant Lite Utility 3-19
 - Preventive maintenance 7-2
 - Product 1-5
- R**
- Recover 7-3
 - Repair 5-10, 7-3
 - Rescuezilla
 - Backup 7-9
 - Restore 7-22
 - Restore 7-3, 7-18, 7-21
- S**
- Software
 - Install 5-7
 - Scheduled defragmentation 5-8
 - Update 7-2
 - Startup 5-2
- T**
- Task scheduler 5-8
 - Touchscreen
 - Calibrate 7-17
 - Trusted Platform Module (TPM) A-3
- U**
- Unified Write Filter (UWF) A-2
 - UPS Log 3-11
 - UPS Status 3-10
- W**
- Windows Defender
 - Virus Definitions 5-5
 - Windows recovery drive 7-7
 - Windows
 - Customize A-2

OMRON Corporation Industrial Automation Company

Kyoto, JAPAN

Contact : www.ia.omron.com

Regional Headquarters

OMRON EUROPE B.V.

Wegalaan 67-69, 2132 JD Hoofddorp
The Netherlands

Tel: (31) 2356-81-300 Fax: (31) 2356-81-388

OMRON ELECTRONICS LLC

2895 Greenspoint Parkway, Suite 200
Hoffman Estates, IL 60169 U.S.A.

Tel: (1) 847-843-7900 Fax: (1) 847-843-7787

OMRON ASIA PACIFIC PTE. LTD.

438B Alexandra Road, #08-01/02 Alexandra
Technopark, Singapore 119968

Tel: (65) 6835-3011 Fax: (65) 6835-3011

OMRON (CHINA) CO., LTD.

Room 2211, Bank of China Tower,
200 Yin Cheng Zhong Road,
PuDong New Area, Shanghai, 200120, China

Tel: (86) 21-6023-0333 Fax: (86) 21-5037-2388

Authorized Distributor:

©OMRON Corporation 2022-2024 All Rights Reserved.
In the interest of product improvement,
specifications are subject to change without notice.

Cat. No. W635-E2-03 0224