

## Terminal Relay

### G6D-F4PU/G3DZ-F4PU (Push-In Plus Technology) G6D-F4B/G3DZ-F4B (Screw Terminal)

#### Model with Push-In Plus technology Added to Terminal Relays with Four-point Output Lineup

- Realized 5 A rating by optimal designs for wide variety of applications (Push-In Plus technology).
- Push-In Plus terminal enables work reduction and requires no retightening.
- Short Bars (order separately) ensure easy common wiring and crossover wiring to adjacent terminal relays.
- Double wire method enables branch wiring (Push-In Plus technology)
- Each relay has independent coils and contacts for PLC output compatible (both NPN and PNP).
- Mechanical Relay models and power MOS FET relay models (for high frequency contact ratings) are available.
- LED operation indicator, diode for coil surge absorption, and tools for easy removal of relays are included as standard equipment.
- UL and CSA certification for standard models.  
VDE certification for Screws terminal, TÜV certification for Push-In Plus terminal.  
IP20 protection code for Push-In Plus models.



For the most recent information on models that have been certified for safety standards, refer to your OMRON website.

**Refer to Safety Precautions on page 12.**

#### Features (G6D-F4PU/G3DZ-F4PU (Model with Push-In Plus technology))

##### Pursuing High Usability

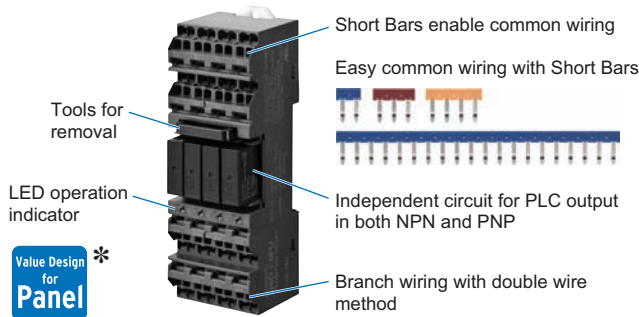

##### Slimmer Width Yet Larger Power Supply Capacity

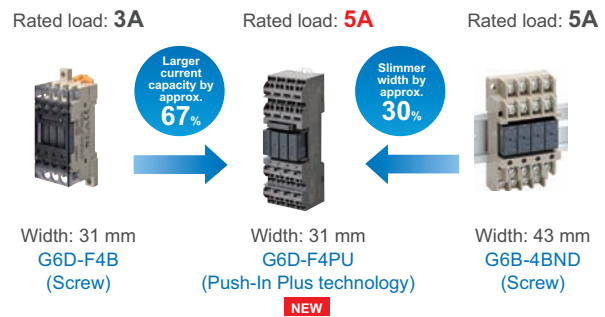

##### Wide Variety of Application

Short Hight for Installation in Narrow Spaces

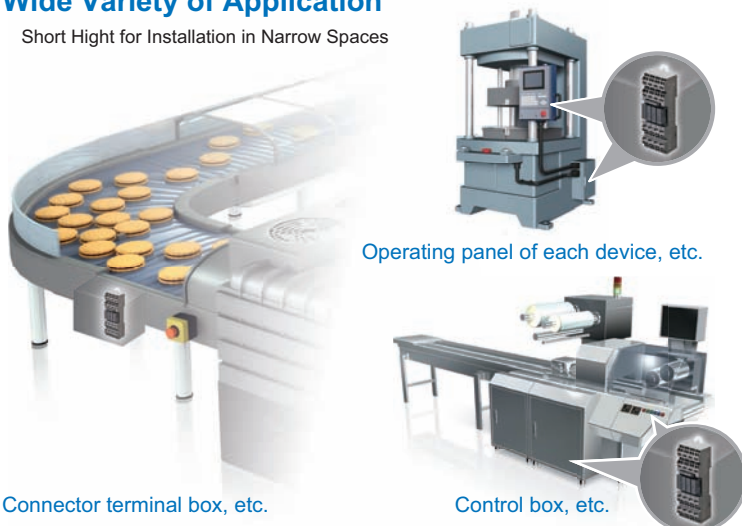

##### Applicable to Various Number of I/O Points

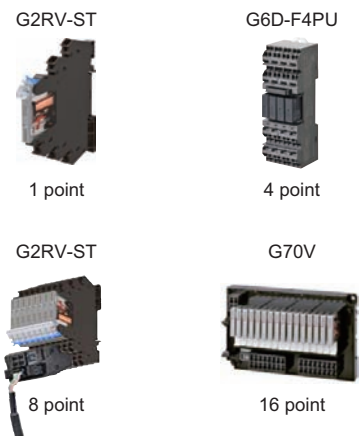

Connector terminal box, etc.

Control box, etc.

\* Value Design for Panel

Our shared concept "Value Design for Panel" for the specifications of products used in control panels (hereinafter called "Value Design") will create new value to your control panels. Combining multiple products that share the Value Design concept will further increase the value provided to control panels.

# G6D-F4PU/G3DZ-F4PU/G6D-F4B/G3DZ-F4B

## Ordering Information

When your order, specify the rated voltage.

### ■ Main unit

#### Model with Push-In Plus technology

Mounted Relay type	Contact form	Model	Operation coil ratings
Mechanical Relay	SPST x 4 (1NO x 4)	<b>G6D-F4PU</b>	12 VDC
			24 VDC
Power MOS FET relay		<b>G3DZ-F4PU</b>	12 VDC
			24 VDC

#### Model with Screw Terminal

Mounted Relay type	Contact form	Model	Operation coil ratings
Mechanical Relay models	SPST x 4 (1NO x 4)	<b>G6D-F4B</b>	12 VDC
			24 VDC
Power MOS FET relay		<b>G3DZ-F4B</b>	12 VDC
			24 VDC

### ■ Accessories (Order Separately)

#### ● Replacement Relay

Applicable Terminal Relay Model	Model	Operation coil ratings
G6D-F4PU/G6D-F4B	<b>G6D-1A-ASI</b>	12 VDC
		24 VDC
G3DZ-F4PU/G3DZ-F4B	<b>G3DZ-2R6PL</b>	12 VDC
		24 VDC

#### ● Connection socket (single sales available)

##### G6D-F4PU/G3DZ-F4PU (Model with Push-In Plus technology)

Model	Operation coil ratings
<b>P6DF-F4PU</b>	12 VDC
	24 VDC

##### G6D-F4B/G3DZ-F4B (Models with Screw terminal)

Model	Operation coil ratings
<b>P6DF-F4B</b>	12 VDC
	24 VDC

- Note:**
1. Connection socket P6DF-F4B as a single part is not certified by safety standards individually.
  2. Single socket which does not mount a relay (with terminal cover)
  3. Only the terminal cover is also available separately.  
Model: G6D-4-C, Minimum order (quantity): 10

## ● Short Bar (G6D-F4PU/G3DZ-F4PU (Model with Push-In Plus technology))

Pitch	Applicable models	Number of poles	Color	Model*1	Maximum carry current
7.75 mm	G6D-F4PU G3DZ-F4PU P6DF-F4PU	2	Red (R) Blue (S) Yellow (Y)	PYDN-7.75-020□	20 A
		3		PYDN-7.75-030□	
		4		PYDN-7.75-040□	
		20		PYDN-7.75-200□	



**Note:** Use the Short Bars for crossover wiring within one Socket or between Sockets.

\*1. Replace the box (□) in the model number with the code for the covering color. Selection of the box (□): R=Red, S=Blue, Y=Yellow

## ● Short Bar (G6D-F4B/G3DZ-F4B (Model with Screw Terminal))

Applicable Terminal Relay Model	Model
G6D-F4B	<b>G6D-4-SB</b>
G3DZ-F4B	

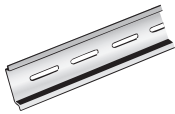
## ● Parts for DIN Track Mounting

Appearance	Type	Model
	DIN Tracks	1 m <b>PFP-100N</b>
		0.5 m <b>PFP-50N</b>
	End Plate *1	<b>PFP-M</b>
	Spacer	<b>PFP-S</b>

\*1. When mounting support rail, please use End Plate (Model PFP-M).

# G6D-F4PU/G3DZ-F4PU/G6D-F4B/G3DZ-F4B

## Ratings/Specifications

### ■ Ratings

#### ● Relay Specification

##### Coil Ratings (per G6D Relay)

Operation coil rating	Rated current (mA)	Coil resistance (Ω)	Must operate voltage (V)	Must release voltage (V)	Max. voltage (V)	Power consumption (mW)	
DC	12	18.7	720	70% max.*	10% min.	130%	Approx. 200
	24	10.5	2,880				

**Note:** 1. Rated current and coil resistance were measured at a coil temperature of 23°C with a tolerance of ±20%.

2. Performance characteristic data are measured at a coil temperature of 23°C.

3. The maximum allowable voltage is the maximum value of the operating voltage for the relay coil operating power supply. There is no continuous allowance.

4. The rated current includes the terminal's LED current.

\* The must operate voltage is 75% or less of the rated voltage if the relay is mounted in the upside down.

##### Contact Ratings (per G6D Relay)

###### G6D-F4PU (Model with Push-In Plus technology)

Item	Load	Resistive load (cosφ = 1)
Rated load	5 A at 250 VAC, 5 A at 30 VDC	
Rated carry current	5 A	
Max. switching voltage	250 VAC, 30 VDC	
Max. switching current	5 A	
Max. switching capacity (reference value)	1,250 VA, 150 W	

###### G6D-F4B (Model with Screw terminal)

Item	Load	Resistive load (cosφ = 1)
Rated load	3 A at 250 VAC, 3 A at 30 VDC	
Rated carry current *	5 A	
Max. switching voltage	250 VAC, 30 VDC	
Max. switching current *	5 A	
Max. switching capacity (reference value) *	1,250 VA, 150 W	

\* The specifications become 3 A, 750 VA, and 90 W when all four outputs are powered at the same time.

### ■ Characteristics

Model		G6D-F4PU (Model with Push-In Plus technology)
Item		Relay output
Contact resistance *1		100 mΩ max.
Operate time *2		10 ms max.
Release time *2		10 ms max.
Insulation resistance		1,000 MΩ min. (at 500 VDC)
Dielectric strength	Between coil and contacts	2,000 VAC, 50/60 Hz for 1 min
	Between contacts of the same polarity	750 VAC, 50/60 Hz for 1 min
Shock resistance voltage (between coil and contacts)		4,000 V (1.2 × 50 μs)
Vibration resistance	Destruction	10 to 55 to 10 Hz, 0.75-mm single amplitude (1.5-mm double amplitude)
	Malfunction	10 to 55 to 10 Hz, 0.75-mm single amplitude (1.5-mm double amplitude)
Shock resistance	Destruction	500 m/s <sup>2</sup>
	Malfunction	100 m/s <sup>2</sup>
Endurance	Mechanical	20,000,000 operations min. (switching frequency: 18,000 operations/hr)
	Electrical *2	70,000 operations min. (5 A at 250 VAC, resistive load) 70,000 operations min. (5 A at 30 VDC, resistive load) (at 1,800 switching frequencies/hr)
Failure rate P Level (reference value *3)		10 mA at 5 VDC
Ambient operating temperature, Ambient storage temperature		-25 to 55°C (with no icing)
Ambient operating humidity		45% to 85%
LED color		Yellow
Sealing		IP20
Weight		Approx. 95 g

**Note:** The data shown above are initial values.

\*1. Measurement condition: 1 A at 5 VDC

\*2. Ambient temperature condition: 23°C

\*3. This value is measured at 120 switching frequencies/min.

Model		G6D-F4B (Model with Screw terminal)
Item		Relay output
Contact resistance *1		100 mΩ max.
Operate time *2		10 ms max.
Release time *2		10 ms max.
Insulation resistance		1,000 MΩ min. (at 500 VDC)
Dielectric strength	Between coil and contacts	2,000 VAC, 50/60 Hz for 1 min
	Between contacts of the same polarity	750 VAC, 50/60 Hz for 1 min
Shock resistance voltage (between coil and contacts)		4,000 V (1.2 × 50 μs)
Vibration resistance	Destruction	10 to 55 to 10 Hz, 0.75-mm single amplitude (1.5-mm double amplitude)
	Malfunction	10 to 55 to 10 Hz, 0.75-mm single amplitude (1.5-mm double amplitude)
Shock resistance	Destruction	500 m/s <sup>2</sup>
	Malfunction	100 m/s <sup>2</sup>
Endurance	Mechanical	20,000,000 operations min. (switching frequency: 18,000 operations/hr)
	Electrical *2	200,000 operations min. (3 A at 250 VAC, resistive load) 200,000 operations min. (3 A at 30 VDC, resistive load) (at 1,800 switching frequencies/hr)
Failure rate P Level (reference value *3)		10 mA at 5 VDC
Ambient operating temperature, Ambient storage temperature		-25 to 55°C (with no icing)
Ambient operating humidity		45% to 85%
LED color		Yellow
Sealing		---
Weight		Approx. 65 g

**Note:** The data shown above are initial values.

\*1. Measurement condition: 1 A at 5 VDC

\*2. Ambient temperature condition: 23°C

\*3. This value is measured at 120 switching frequencies/min.

## ■ Ratings

### ● Power MOS FET Relay Specifications

#### Input (per G3DZ Power MOS FET Relay)

Rated voltage	Operating voltage	Must operate voltage level	Must release voltage level	Input impedance	Rated current	
DC	12	9.6 to 14.4 VDC	9.6 VDC max.	1 VDC min.	2 kΩ ±20%	8.0 mA ±20%
	24	19.2 to 28.8 VDC	19.2 VDC max.		4 kΩ ±20%	8.2 mA ±20%

**Note:** The rated current includes the terminal's LED current.

#### Output (per G3DZ Power MOS FET Relay)

Rated operating voltage	Load voltage range	Load current	Inrush current resistance
5 to 240 VAC 5 to 100 VDC	3 to 264 VAC 3 to 125 VDC	100 μ to 0.3 A	6 A (10 ms)

**Note:** There is no output polarity for the G3DZ.

## ■ Characteristics

Item	Model
	G3DZ-F4PU (Model with Push-In Plus technology) Power MOS FET relay output
Must operate time	10 ms max.
Release time	15 ms max.
Output ON-resistance	2.4 Ω max.
Leakage current at OFF state	10 μA max. (at 125 VDC)
Insulation resistance	100 MΩ min. (at 500 VDC)
Dielectric strength between I/O	2,000 VAC, 50/60 Hz for 1 min
Vibration resistance	10 to 55 to 10 Hz, 0.75-mm single amplitude (1.5-mm double amplitude)
Shock resistance	500 m/s <sup>2</sup>
Ambient operating temperature, Ambient storage temperature	-25 to 55°C (with no icing)
Ambient operating humidity	45% to 85%
LED color	Yellow
Sealing	IP20
Weight	Approx. 95 g

Item	Model
	G3DZ-F4B (Model with Screw terminal) Power MOS FET relay output
Must operate time	10 ms max.
Release time	15 ms max.
Output ON-resistance	2.4 Ω max.
Leakage current at OFF state	10 μA max. (at 125 VDC)
Insulation resistance	100 MΩ min. (at 500 VDC)
Dielectric strength between I/O	2,000 VAC, 50/60 Hz for 1 min
Vibration resistance	10 to 55 to 10 Hz, 0.75-mm single amplitude (1.5-mm double amplitude)
Shock resistance	500 m/s <sup>2</sup>
Ambient operating temperature, Ambient storage temperature	-25 to 55°C (with no icing)
Ambient operating humidity	45% to 85%
LED color	Yellow
Sealing	---
Weight	Approx. 65 g

# G6D-F4PU/G3DZ-F4PU/G6D-F4B/G3DZ-F4B

## ■ Ratings for Safety Standard Certification

The rated values for safety standard certification are not the same as individually defined performance values. Always check the specifications before use.

### G6D-F4PU/G3DZ-F4PU

#### ●UL-certified Models (File No. E41515)

Model	Standard number	Category	Listed/ Recognized Classification	Operating coil ratings	Number of poles	Contact ratings	Operations
G6D-F4PU	UL508	NRNT/7	Listed	12 VDC 24 VDC	4	Rated load voltage 250 VAC 30 VDC Load Current, General Use and Resistive 5 A	6,000 operations.
G3DZ-F4PU						Rated load voltage 5-240 VAC 5-100 VDC Load Current, General Use and Resistive 0.3 A	
P6DF-F4PU		SWIV2	Recognized			5 A, 250 V	---

#### ●CSA-certified Models (File No. LR35535)

Model	Standard number	Class number	Operating coil ratings	Number of poles	Contact ratings	Operations
P6DF-F4PU	C22.2 NO. 14	CLASS 3211 07	12 VDC 24 VDC	4	5 A, 250 V	---

#### ●TÜV Rheinland Certification (Certification No.R50429253)

Model	Operating Coil ratings	Number of poles	Contact ratings	Operations
G6D-F4PU	12 VDC 24 VDC	4	AC250 V, 5 A (Res.) DC30 V, 5 A (Res.)	70,000 operations 70,000 operations

#### ●TÜV Rheinland Certification (Certification No.R50429249)

Model	Operating Coil ratings	Number of poles	Contact ratings	Operations
G3DZ-F4PU	12 VDC 24 VDC	4	AC5-240 V, 5 A (Res.) DC5-100 V, 5 A (Res.)	---

#### ●TÜV Rheinland Certification (Certification No.50429224)

Model	Operating Coil ratings	Number of poles	Contact ratings	Operations
P6DF-F4PU	12 VDC 24 VDC	4	AC250 V, 5 A DC100 V, 5 A	---

## G6D-F4B/G3DZ-F4B

### ● UL-certified Models (File No. E87929)

Model	Standard number	Category	Listed/ Recognized Classification	Operating coil ratings	Number of poles	Contact ratings	Operations
G6D-F4B	UL508	SWIV2	Recognized	12 VDC 24 VDC	4	Rated load voltage 250 VAC 30 VDC  Load Current 5 A, Resistive	6,000 operations.
G3DZ-F4B						Rated load voltage 3-264 VAC 3-125 VDC  Load Current 0.3 A	---

### ● CSA-certified Models (File No. LR35535)

Model	Standard number	Class number	Operating coil ratings	Number of poles	Contact ratings	Operations
G6D-F4B	C22.2 NO. 14	CLASS 3211 07	12 VDC 24 VDC	4	Rated load voltage 250 VAC 30 VDC  Load Current 5 A, Resistive	---
G3DZ-F4B					Rated load voltage 3-264 VAC 3-125 VDC  Load Current 0.3 A, Resistive	---

### ● VDE Certification (Certification No.40017757)

Model	Operating coil ratings	Number of poles	Contact ratings	Operations
G6D-F4B	12 VDC 24 VDC	4	250 VAC, 3 A 24 VDC, 3 A	---

### ● VDE Certification (Certification No.40046252)

Model	Operating coil ratings	Number of poles	Contact ratings	Operations
G3DZ-F4B	12 VDC 24 VDC	4	5-240 VAC, 0.3 A 5-100 VDC, 0.3 A	---

### ● VDE Certification (Certification No.40046241)

Model	Operating coil ratings	Number of poles	Contact ratings	Operations
P6DF-F4B	12 VDC 24 VDC	4	250 VAC, 0.3 A	---

# G6D-F4PU/G3DZ-F4PU/G6D-F4B/G3DZ-F4B

## Engineering Data

### Engineering Data

#### ● G6D-F4PU

##### Maximum Switching Capacity

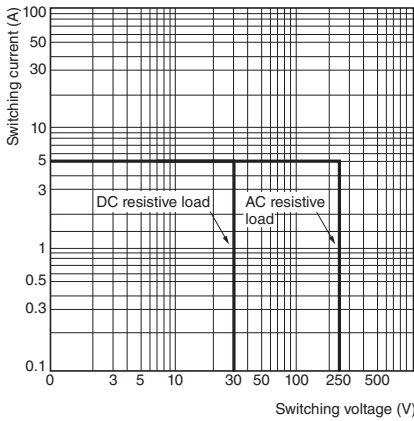

##### Endurance Curve

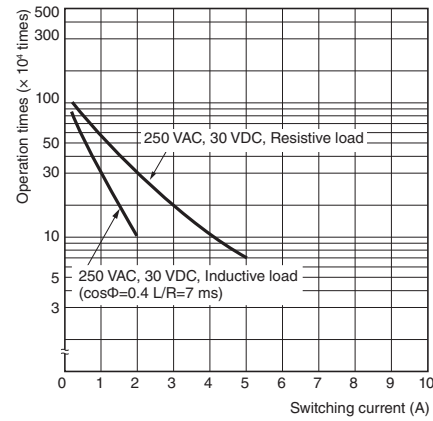

##### Load Current vs. Ambient Temperature (Product specification)

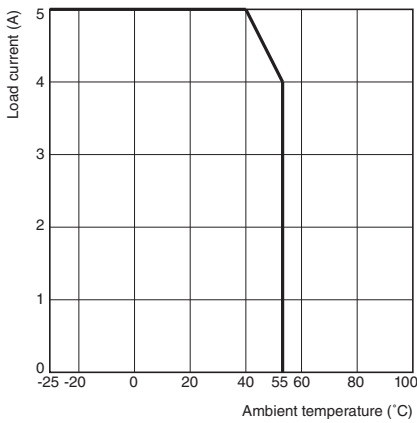

##### Load Current vs. Ambient Temperature (Specifications with UL and TÜV certification)

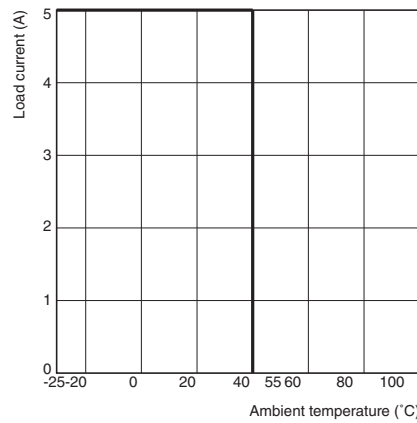

#### ● G6D-F4B (Per G6D relay)

##### Maximum Switching Capacity

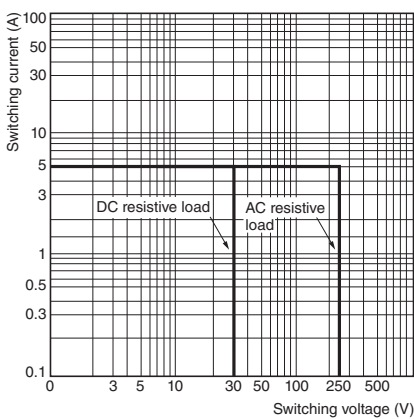

##### Endurance Curve

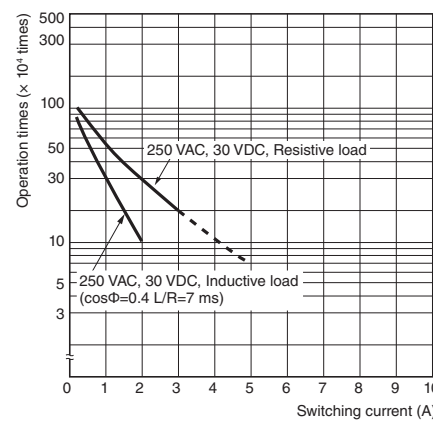

**Note:** The maximum value becomes 3 A when all four outputs are powered at the same time.



● G3DZ-F4PU

Load Current vs. Ambient Temperature Inrush current resistance

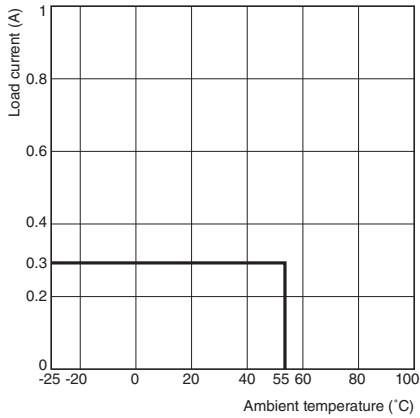

Non-repetitive  
(Keep the inrush current to below the inrush current resistance value (i.e., below the broken line) if it occurs repetitively.)

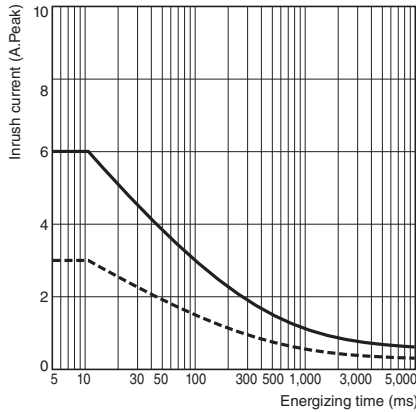

**Note:** These data are actual measured values that were sampled from the production line and prepared in graph format, and are for reference purposes only. A relay is manufactured by mass production, and as a basic rule must be used with allowance made for a certain amount of deviation.

● G3DZ-F4B

Load Current vs. Ambient Temperature Inrush current resistance

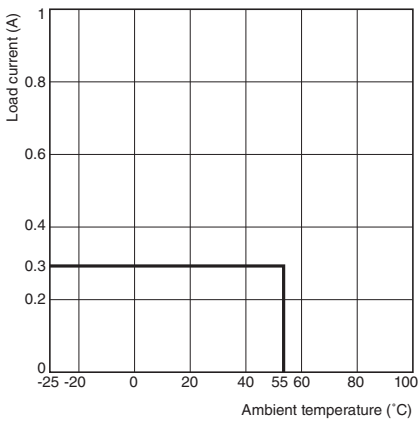

Non-repetitive  
(Keep the inrush current to below the inrush current resistance value (i.e., below the broken line) if it occurs repetitively.)

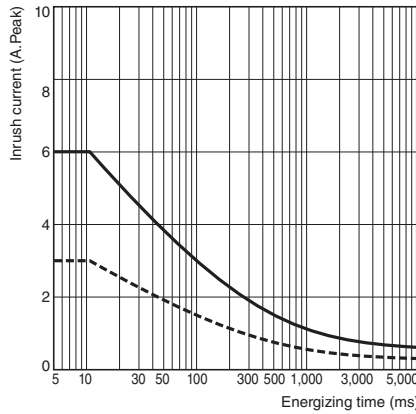

**Note:** These data are actual measured values that were sampled from the production line and prepared in graph format, and are for reference purposes only. A relay is manufactured by mass production, and as a basic rule must be used with allowance made for a certain amount of deviation.

# G6D-F4PU/G3DZ-F4PU/G6D-F4B/G3DZ-F4B

## Dimensions

(Unit: mm)

### ■ Main unit

#### G6D-F4PU G3DZ-F4PU

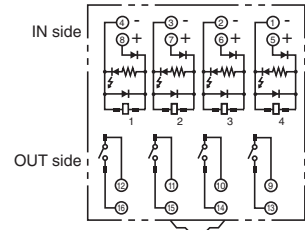
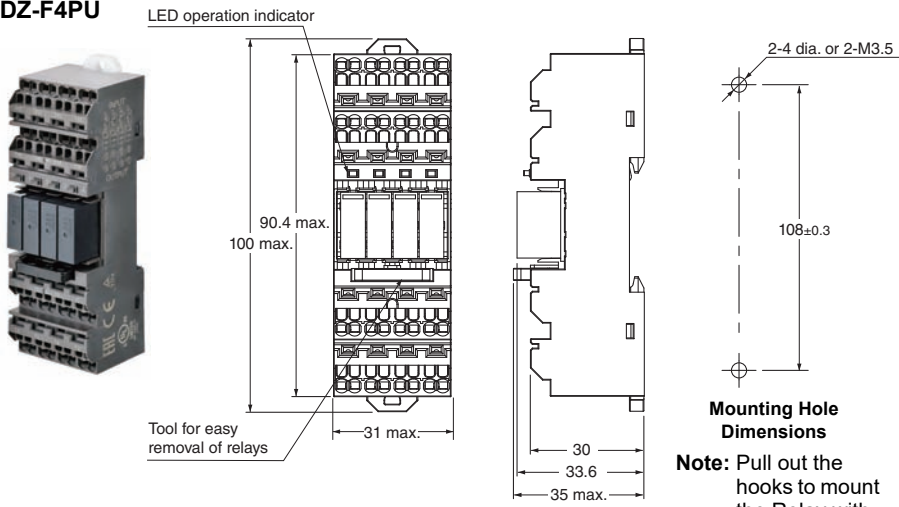

- Note:**
1. Pay utmost attention not to make mistakes with the polarity of the input terminals.
  2. There is no output polarity for G6D-F4PU/G3DZ-F4PU.

#### Mounting Hole Dimensions

**Note:** Pull out the hooks to mount the Relay with screws.

#### Terminal Connection Examples

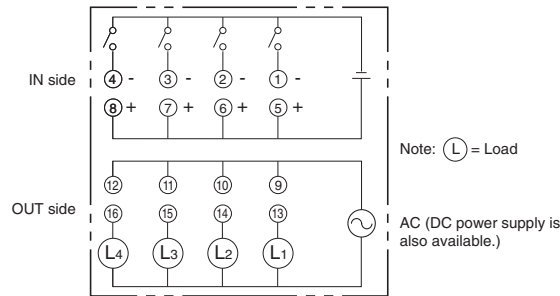

#### G6D-F4B G3DZ-F4B

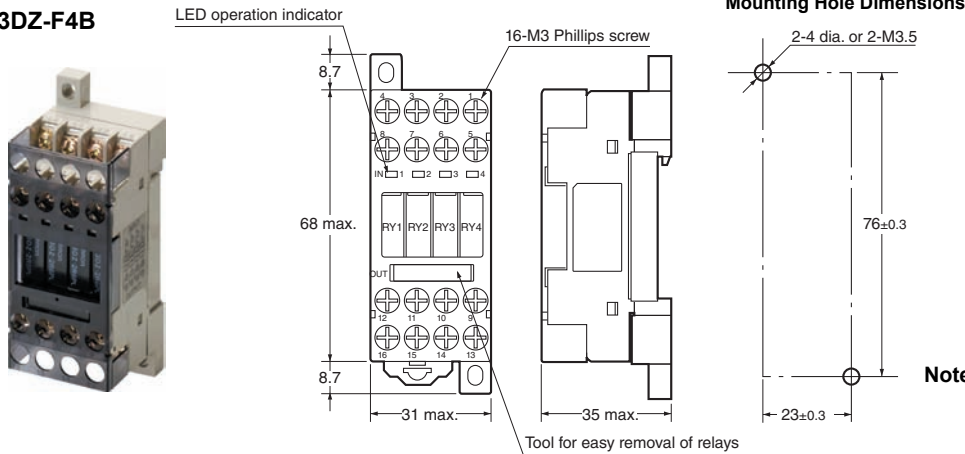

#### Terminal Arrangement/Internal Connection Diagram (Top View)

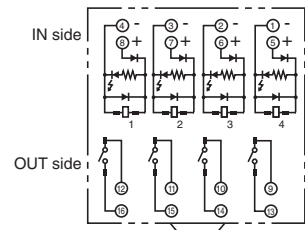

- Note:**
1. Pay utmost attention not to make mistakes with the polarity of the input terminals.
  2. There is no output polarity for G6D-F4B/G3DZ-F4B.

#### Mounting Hole Dimensions

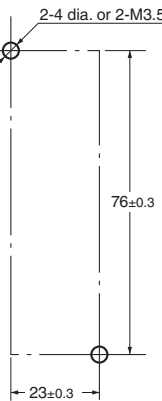

#### Terminal Connection Examples

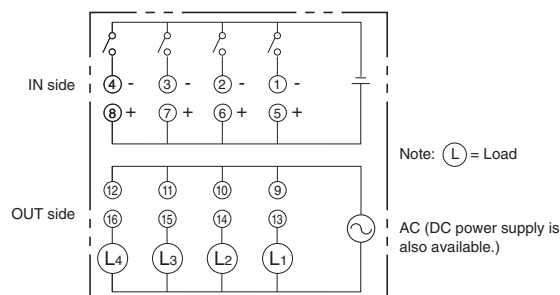

■ Accessories (Order Separately)

● Short Bars

PYDN-7.75-□□ (7.75 mm)

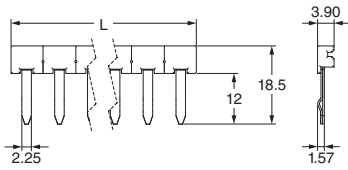

Pitch	Applicable model	Number of poles	L (Length)	Color	Model*
7.75 mm	G6D-F4PU G3DZ-F4PU P6DF-F4PU	2	15.1	Red (R) Blue (S) Yellow (Y)	PYDN-7.75-020□
		3	22.85		PYDN-7.75-030□
		4	30.6		PYDN-7.75-040□
		20	154.6		PYDN-7.75-200□

\* Replace the box (□) in the model number with the code for the covering color. Selection of the box (□): R=Red, S=Blue, Y=Yellow

**Note:** Use the Short Bars for crossover wiring within one Socket or between Sockets.

● Short Bars

G6D-4-SB

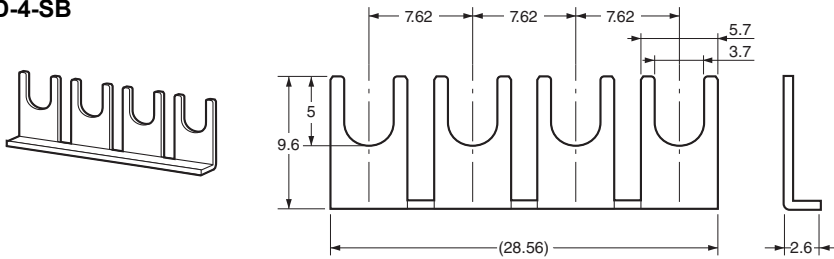

● Parts for DIN Track Mounting

DIN Tracks

PFP-100N

PFP-50N

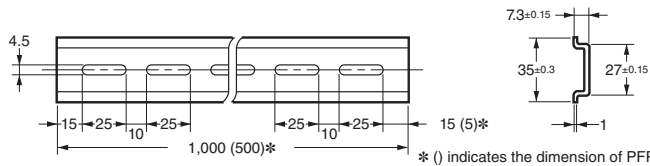
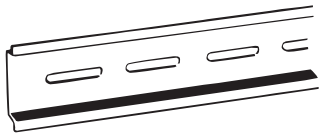

\* ( ) indicates the dimension of PFP-50N.

End Plate

PFP-M

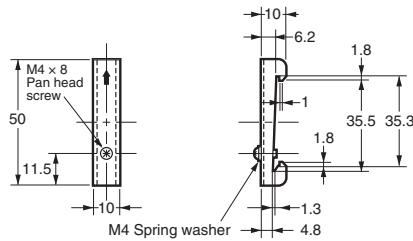

Spacer

PFP-S

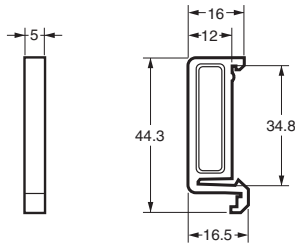
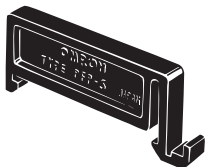

## Safety Precautions

Be sure to read the Common Precautions for All Relays in the website.

### Warning Indications

<b>Precautions for Safe Use</b>	Supplementary comments on what to do or avoid doing, to use the product safely.
<b>Precautions for Correct Use</b>	Supplementary comments on what to do or avoid doing, to prevent failure to operate, malfunction, or undesirable effects on product performance.

### Precautions for Safe Use

#### ● Transport

- Do not transport the I/O Relay Terminal under the following locations. Doing so may occasionally result in damage, malfunction, or deterioration of performance characteristics.
  - Locations subject to water or oil
  - Locations subject to high temperature or high humidity
  - Locations subject to condensation as the result of rapid changes in temperature.
- Do not transport a Socket when it is not packaged. Damage or failure may occur.

#### ● Operating and Storage Environments

- Do not use or store the I/O Relay Terminal in the following locations. Doing so may result in damage, malfunction, or deterioration of performance characteristics.
  - Locations subject to rainwater or water splashes.
  - Locations subject to exposure to water, oil, or chemicals.
  - Locations subject to high temperature or high humidity.
  - Storage at locations subject to ambient temperatures outside the range -25 to 55°C
  - Usage at locations subject to ambient temperatures outside the range -25 to 55°C
  - Locations subject to relative humidity outside the range 45% to 85%
  - Locations subject to condensation as the result of rapid changes in temperature.
  - Locations subject to corrosive or flammable gases.
  - Locations subject to dust, salts, or iron, or locations where there is salt damage
  - Locations subject to direct sunlight.
  - Locations subject to shock or vibration.

#### ● Installation and Mounting

- Mount the I/O Relay Terminal in the specified direction. Otherwise excessive heat generated by the I/O Relay Terminal may occasionally cause burning.

##### Mounting Directions

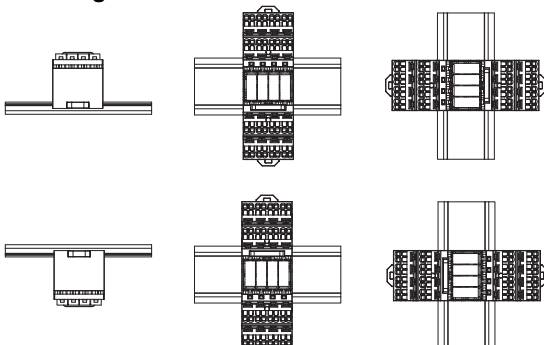

- Mount the I/O Relay Terminal firmly to a DIN Track. Otherwise, the I/O Relay Terminal may fall off.
- Do not handle the I/O Relay Terminal with oily or dusty (especially iron dust) hands.
- Make sure that there is no excessive ambient temperature rise due to the heat generation of the I/O Relay Terminal. If the I/O Relay Terminal is mounted inside a panel, install a fan so that the interior of the panel is fully ventilated.

#### ● Installation and Wiring

- Use wires that are suited to the load current and voltage. Otherwise, excessive heat generated by the wires may cause burning or may cause the wire covering to melt, possibly leading to electric shock.
- Do not use wires with a damaged outer covering. It may result in electric shock or ground leakage. It may result in electric shock or ground leakage.
- Do not wire any wiring in the same duct or conduit as power or high-tension lines. Inductive noise may damage the I/O Relay Terminal or cause it to malfunction.
- Do not apply a voltage or current that exceeds the rating to any terminal. Doing so may result in failure or burning.
- Do not use a deforming Short Bars. Doing so may result in damage, malfunction, or deterioration of performance characteristics.

#### ● Push-In Plus Terminal

- Do not wire anything to the release holes.
- Do not tilt or twist the screwdriver while it is inserted into a release hole on the terminal. The terminal may be damaged.
- Insert a flat-blade screwdriver into the release holes at an angle. The terminal may be damaged if you insert the screwdriver straight in.
- Do not allow the flat-blade screwdriver to fall out while it is inserted into a release hole.
- Do not bend a wire past its natural bending radius or pull on it with excessive force. Doing so may cause the wire disconnection.
- Do not insert more than one wire into each terminal insertion hole.
- To prevent wire materials from smoking or ignition, confirm wire ratings and use the wiring materials given in the following table. \*

Recommended wires	Stripping length
0.5 to 1.5 mm <sup>2</sup> / AWG20 to AWG16 stranded wire, 0.5 to 1.5 mm <sup>2</sup> / AWG20 to AWG16 solid wire	8 mm

\* The recommended wire gauge and stripping length values are for stranded wire or solid wire. When using ferrules, refer to the table of recommended ferrules in Precautions for Correct Use.

#### ● Application

- Select a load within the rated values. Not doing so may result in malfunction, failure, or burning.
- The G6D may occasionally rupture if short-circuit current flows. As protection against accidents due to short-circuiting, be sure to install protective devices, such as fuses and no-fuse breakers, on the power supply side.
- Use a power supply within the rated frequencies. Otherwise, malfunction, failure, or burning may occasionally occur.
- Minor electrical shock may occasionally occur if you touch the power charging area such as the terminal wiring area. Always turn OFF the power supply before performing wiring.

- Insert Short Bars so that the protrusion part of a Short Bar comes to the wire insertion side. If the Short Bar is inserted in the upside down direction, the Short Bar may not be inserted securely.

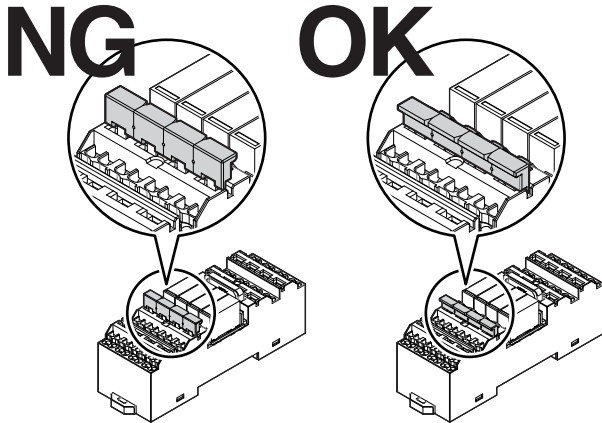

## ● Recommended Ferrules and Crimp Tools

### Recommended ferrules

Applicable wire		Ferrules Conductor length (mm)	Stripping length [mm] (Ferrules used)	Recommended ferrules		
(mm <sup>2</sup> )	(AWG)			Manufactured by Phoenix Contact	Manufactured by Weidmuller	Manufactured by Wago
0.25	24	8	10	AI0,25-8	H0.25/12	216-301
		10	12	AI0,25-10	---	---
0.34	22	8	10	AI0,34-8	H0.34/12	216-302
		10	12	AI0,34-10	---	---
0.5	20	8	10	AI0,5-8	H0.5/14	216-201
		10	12	AI0,5-10	H0.5/16	216-241
0.75	18	8	10	AI0,75-8	H0.75/14	216-202
		10	12	AI0,75-10	H0.75/16	216-242
1/1.25	18/17	8	10	AI1-8	H1.0/14	216-203
		10	12	AI1-10	H1.0/16	216-243
1.25/1.5	17/16	8	10	AI1,5-8	H1.5/14	216-204
		10	12	AI1,5-10	H1.5/16	216-244
Recommended crimp tool				CRIMPFOX6 CRIMPFOX6T-F CRIMPFOX10S	PZ6 roto	Variocrimp4

- Note:**
1. Make sure that the outer diameter of the wire coating is smaller than the inner diameter of the insulation sleeve of the recommended ferrule.
  2. Make sure that the ferrule processing dimensions conform to the following figures.

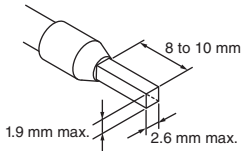

3. Wires of AWG24 to AWG22/0.25 mm<sup>2</sup> to 0.34 mm<sup>2</sup> are not certified by UL standard.
4. Do not connect a ferrule for the applicable wires (AWG17 to AWG16/1.25 mm<sup>2</sup> to 1.5 mm<sup>2</sup>) with an adjacent terminal insertion hole.

## Precautions for Correct Use

- Do not drop the Socket or subject it to abnormal vibration or shock during transportation or mounting. Doing so may result in deterioration of performance, malfunction, or failure.
- Use a power supply with low noise.

## ● G6D-F4PU/G3DZ-F4PU (Model with Push-In Plus technology)

### 1. Connecting Wires to the Push-In Plus Terminal

#### Part Names of the Terminal

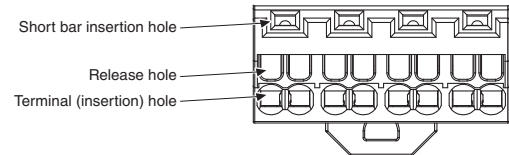

#### Connecting Wires with Ferrules and Solid Wires

Insert the solid wire or ferrule straight into the terminal until the end strikes the terminal.

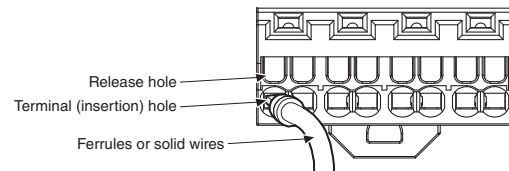

- If a wire is difficult to connect because it is too thin, use a flat-blade screwdriver in the same way as when connecting stranded wire.

#### Connecting Stranded Wires

Use the following procedure to connect the wires to the terminal.

1. Hold a flat-blade screwdriver at an angle and insert it into the release hole.  
The angle should be between 10° and 15°. If the flat-blade screwdriver is inserted correctly, you will feel the spring in the release hole.
2. With the flat-blade screwdriver still inserted into the release hole, insert the wire into the terminal hole until it strikes the terminal.
3. Remove the flat-blade screwdriver from the release hole.

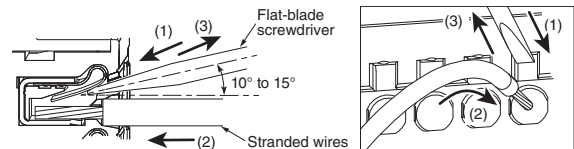

#### Checking Connections

- After the insertion, pull gently on the wire to make sure that it will not come off and the wire is securely fastened to the terminal.
- To prevent short circuits, insert the stripped part of a stranded or solid wire or the conductor part of a ferrule until it is hidden inside the terminal insertion hole.
- If you use recommended ferrules, part of the conductor may be visible after the ferrule is inserted into the terminal, but the product insulation distance will still be satisfied.

## 2. Removing Wires from the Push-In Plus Terminal

Use the following procedure to remove wires from the terminal. The same method is used to remove stranded wires, solid wires, and ferrules.

1. Hold a flat-blade screwdriver at an angle and insert it into the release hole.
2. With the flat-blade screwdriver still inserted into the release hole, remove the wire from the terminal insertion hole.
3. Remove the flat-blade screwdriver from the release hole.

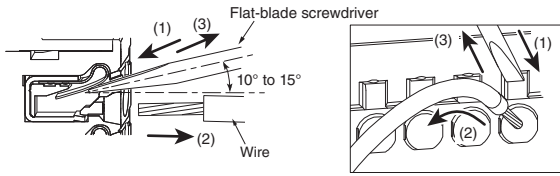

### Recommended Flat-blade Screwdriver

Use a flat-blade screwdriver to connect and remove wires.

Use the following flat-blade screwdriver.

The following table shows manufacturers and models as of 2018/Dec.

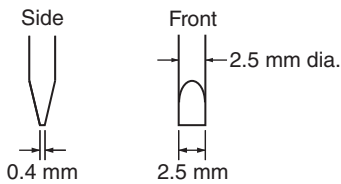

Model	Manufacturer
ESD 0,40×2,5	Wera
SZS 0,4×2,5 SZF 0-0,4×2,5 *	Phoenix Contact
0.4×2.5×75 302	Wiha
AEF.2,5×75	Facom
210-719	Wago
SDIS 0.4×2.5×75	Weidmuller
9900 (-2.5 × 75)	Vessel

\* OMRON's exclusive purchase model XW4Z-00B is available to order as SZF 0-0,4×2,5 (manufactured by Phoenix Contact).

## ● Relay Replacement

- Use the Relay Removal Tool provided with the Unit to dismount a Terminal Relay.
- Always turn OFF the power supply before replacing Relays.
- When mounting Relays, take care to vertically insert the sockets of relays into the contact pins properly.
- Relays with other models or other voltages cannot be mounted together.

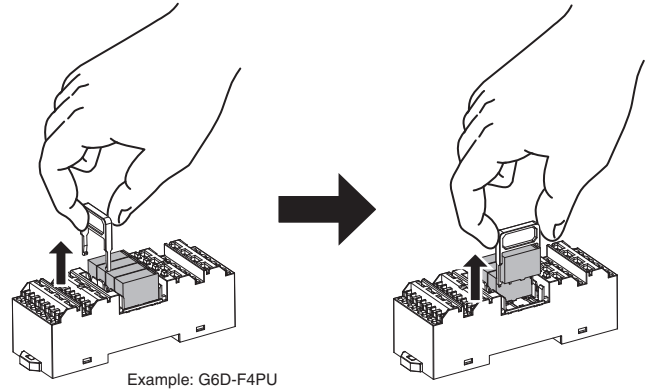

## ● Removing the Terminal Cover (G6D-F4B)

Hold the base side of the terminal cover as shown in the diagram, and remove the terminal cover by pulling it in upward.

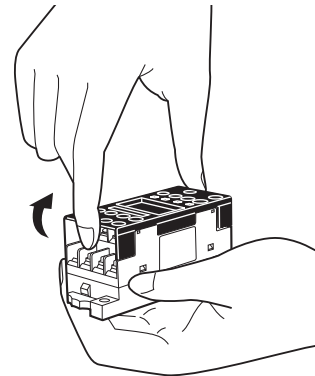

## ● Mountable Relays

Relays and SSRs cannot be mounted together.

# Terms and Conditions Agreement

## **Read and understand this catalog.**

Please read and understand this catalog before purchasing the products. Please consult your OMRON representative if you have any questions or comments.

## **Warranties.**

- (a) Exclusive Warranty. Omron's exclusive warranty is that the Products will be free from defects in materials and workmanship for a period of twelve months from the date of sale by Omron (or such other period expressed in writing by Omron). Omron disclaims all other warranties, express or implied.
- (b) Limitations. OMRON MAKES NO WARRANTY OR REPRESENTATION, EXPRESS OR IMPLIED, ABOUT NON-INFRINGEMENT, MERCHANTABILITY OR FITNESS FOR A PARTICULAR PURPOSE OF THE PRODUCTS. BUYER ACKNOWLEDGES THAT IT ALONE HAS DETERMINED THAT THE PRODUCTS WILL SUITABLY MEET THE REQUIREMENTS OF THEIR INTENDED USE.

Omron further disclaims all warranties and responsibility of any type for claims or expenses based on infringement by the Products or otherwise of any intellectual property right. (c) Buyer Remedy. Omron's sole obligation hereunder shall be, at Omron's election, to (i) replace (in the form originally shipped with Buyer responsible for labor charges for removal or replacement thereof) the non-complying Product, (ii) repair the non-complying Product, or (iii) repay or credit Buyer an amount equal to the purchase price of the non-complying Product; provided that in no event shall Omron be responsible for warranty, repair, indemnity or any other claims or expenses regarding the Products unless Omron's analysis confirms that the Products were properly handled, stored, installed and maintained and not subject to contamination, abuse, misuse or inappropriate modification. Return of any Products by Buyer must be approved in writing by Omron before shipment. Omron Companies shall not be liable for the suitability or unsuitability or the results from the use of Products in combination with any electrical or electronic components, circuits, system assemblies or any other materials or substances or environments. Any advice, recommendations or information given orally or in writing, are not to be construed as an amendment or addition to the above warranty.

See <http://www.omron.com/global/> or contact your Omron representative for published information.

## **Limitation on Liability: Etc.**

OMRON COMPANIES SHALL NOT BE LIABLE FOR SPECIAL, INDIRECT, INCIDENTAL, OR CONSEQUENTIAL DAMAGES, LOSS OF PROFITS OR PRODUCTION OR COMMERCIAL LOSS IN ANY WAY CONNECTED WITH THE PRODUCTS, WHETHER SUCH CLAIM IS BASED IN CONTRACT, WARRANTY, NEGLIGENCE OR STRICT LIABILITY.

Further, in no event shall liability of Omron Companies exceed the individual price of the Product on which liability is asserted.

## **Suitability of Use.**

Omron Companies shall not be responsible for conformity with any standards, codes or regulations which apply to the combination of the Product in the Buyer's application or use of the Product. At Buyer's request, Omron will provide applicable third party certification documents identifying ratings and limitations of use which apply to the Product. This information by itself is not sufficient for a complete determination of the suitability of the Product in combination with the end product, machine, system, or other application or use. Buyer shall be solely responsible for determining appropriateness of the particular Product with respect to Buyer's application, product or system. Buyer shall take application responsibility in all cases.

NEVER USE THE PRODUCT FOR AN APPLICATION INVOLVING SERIOUS RISK TO LIFE OR PROPERTY OR IN LARGE QUANTITIES WITHOUT ENSURING THAT THE SYSTEM AS A WHOLE HAS BEEN DESIGNED TO ADDRESS THE RISKS, AND THAT THE OMRON PRODUCT(S) IS PROPERLY RATED AND INSTALLED FOR THE INTENDED USE WITHIN THE OVERALL EQUIPMENT OR SYSTEM.

## **Programmable Products.**

Omron Companies shall not be responsible for the user's programming of a programmable Product, or any consequence thereof.

## **Performance Data.**

Data presented in Omron Company websites, catalogs and other materials is provided as a guide for the user in determining suitability and does not constitute a warranty. It may represent the result of Omron's test conditions, and the user must correlate it to actual application requirements. Actual performance is subject to the Omron's Warranty and Limitations of Liability.

## **Change in Specifications.**

Product specifications and accessories may be changed at any time based on improvements and other reasons. It is our practice to change part numbers when published ratings or features are changed, or when significant construction changes are made. However, some specifications of the Product may be changed without any notice. When in doubt, special part numbers may be assigned to fix or establish key specifications for your application. Please consult with your Omron's representative at any time to confirm actual specifications of purchased Product.

## **Errors and Omissions.**

Information presented by Omron Companies has been checked and is believed to be accurate; however, no responsibility is assumed for clerical, typographical or proofreading errors or omissions.

**Note: Do not use this document to operate the Unit.**

**OMRON Corporation Industrial Automation Company**

**Kyoto, JAPAN**

**Contact : [www.ia.omron.com](http://www.ia.omron.com)**

**Regional Headquarters**

**OMRON EUROPE B.V.**

Wegalaan 67-69, 2132 JD Hoofddorp  
The Netherlands  
Tel: (31) 2356-81-300 Fax: (31) 2356-81-388

**OMRON ELECTRONICS LLC**

2895 Greenspoint Parkway, Suite 200  
Hoffman Estates, IL 60169 U.S.A.  
Tel: (1) 847-843-7900 Fax: (1) 847-843-7787

**OMRON ASIA PACIFIC PTE. LTD.**

438B Alexandra Road, #08-01/02 Alexandra  
Technopark, Singapore 119968  
Tel: (65) 6835-3011 Fax: (65) 6835-3011

**OMRON (CHINA) CO., LTD.**

Room 2211, Bank of China Tower,  
200 Yin Cheng Zhong Road,  
PuDong New Area, Shanghai, 200120, China  
Tel: (86) 21-6023-0333 Fax: (86) 21-5037-2388

**Authorized Distributor:**

©OMRON Corporation 2019-2024 All Rights Reserved.  
In the interest of product improvement,  
specifications are subject to change without notice.

**CSM\_1\_8**

**Cat. No. J228-E1-07 0424 (0319)**