

SX (400 V)

V2.1

High performance Vector Control

- New operator with Real-Time Clock
- IM & PM motor control
- IP20 & IP54 wide range
- Built-in Filter according to C3 Class
- Built-in Fuses (From 220 kW)
- Safety EN62061:2005 SIL 3
- Load curve control
- HCB technology (Half controlling Bridge)
- Logic programmability
- Pre-maintenance alarms
- Options flexibility (I/O's, Fieldbus, PTC/PT100, Multiple Pump control, Encoder, Crane control)
- Built-in RS-485 Modbus
- Communication options (EtherCAT, PROFINET, Modbus, DeviceNet, PROFIBUS, Modbus TCP)
- Embedded 24 VDC standby power supply
- Liquid cooling drive version
- 12-pulse rectifier option
- CE, UL, RoHS, DNV, EAC



Ratings

- 400 V Class three-phase 0.75 kW to 1,400 kW

System configuration

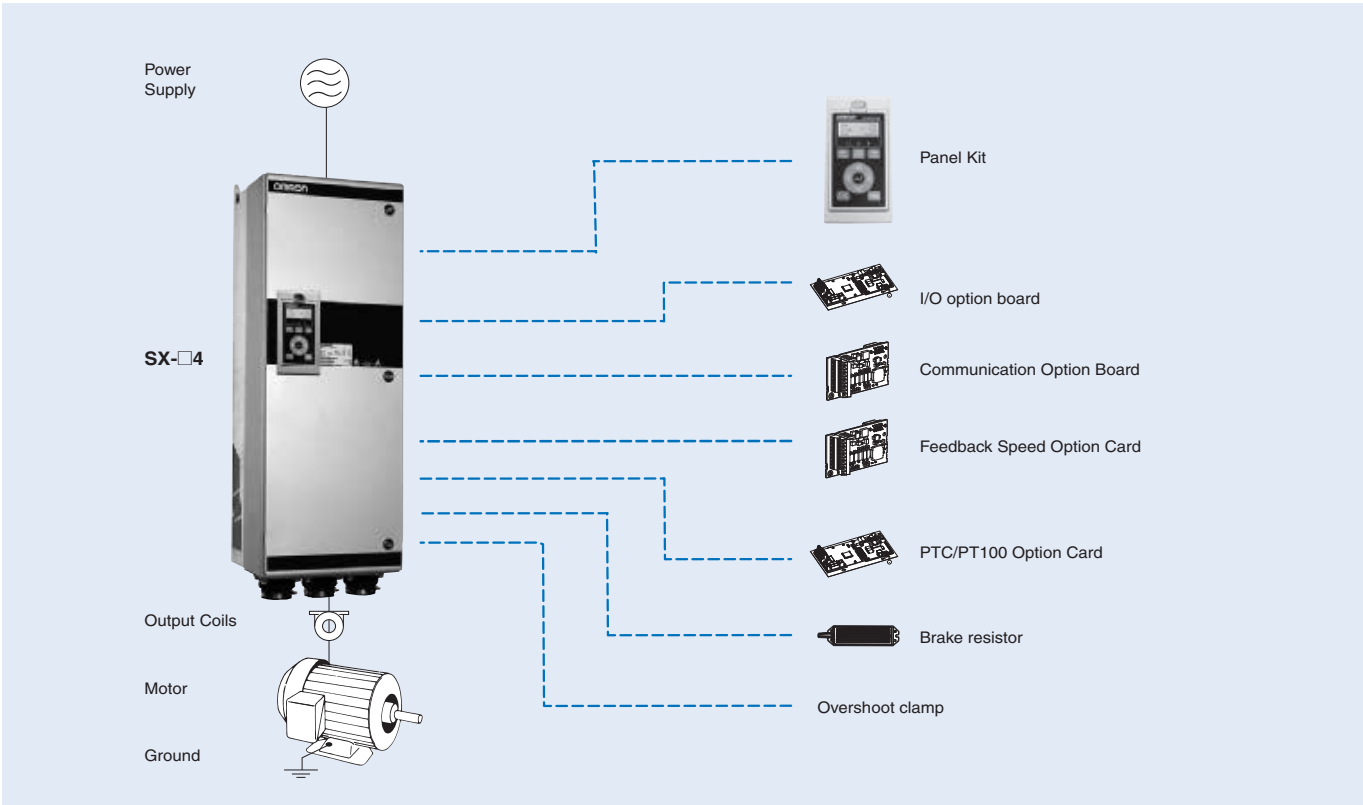

Specifications

Type designation

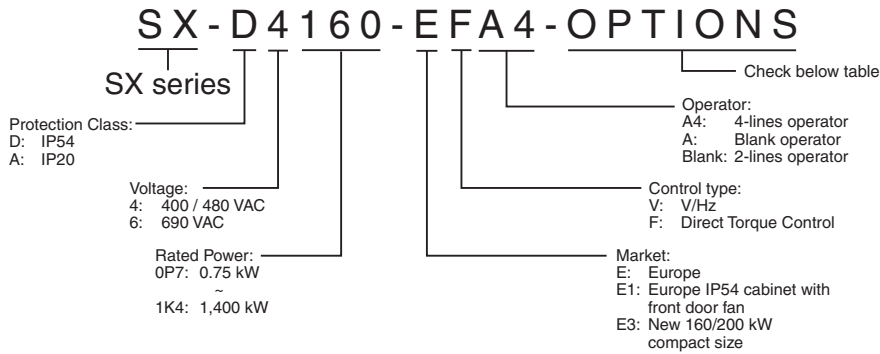

Options available

Options	Letter ("?" means no character)	Options	Letter ("?" means no character)
Built-in EMC filter	"?" = Standard EMC filter (Category C3) "B" = IT-Net (filter disconnected from ground) "B1" = EMC filter (Category C2)	Option board Fieldbus position 4	"?" = No option "L" = DeviceNet "M" = PROFIBUS-DP "M1" = PROFINET (1-port) "M2" = PROFINET (2-ports) "N" = RS232/485 "O" = Ethernet Modbus TCP "O1" = EtherCAT
Built-in brake chopper	"?" = No brake chopper or DC-connection included "C" = Brake chopper & DC-connection included "D" = Only DC-connection included	Liquid Cooling	"?" = No Liquid Cooling "P" = Liquid Cooling
Safe stop	"?" = Not included "F" = Safe stop included	Standard	"?" = IEC "Q" = UL
Coated boards ^{*1}	"?" = No coating "G" = Coated boards	Marine ^{*2}	"?" = No marine option "R" = Marine option included
Option board position 1	"?" = No option "H" = Crane I/O "I" = Encoder "J" = PTC/PT100 "K" = Extended I/O	Cabinet input options	"?" = No cabinet input options "S" = Main switch included "T" = Main contactor included "U" = Main switch + contactor included
Option board position 2	"?" = No option "I" = Encoder "J" = PTC/PT100 "K" = Extended I/O	Cabinet output options	"?" = No cabinet output options included "V" = dV/dt filter included "W" = dV/dt filter + Overshoot clamp included "X" = Sinusfilter included "X1" = All-pole sinus filter included
Option board position 3	"?" = No option "I" = Encoder "J" = PTC/PT100 "K" = Extended I/O	Additional options	"Z1" = Common mode output filter "Z2" = Cable gland kit "Z3" = Motor PTC connection Only models from 0.37 to 37KW

^{*1} IP20 models from 11 kW to 200 kW are coated from factory.

^{*2} Marine option is not available for IP20 models from 11 kW to 200 kW.

400 V class

Three-phase: SX-□4□□□-E□		0P7	1P5	2P2	3P0	4P0	5P5	7P5	011	015	018	022	030
Motor kW ¹	For HD setting	0.55	1.1	1.5	2.2	3	4	5.5	7.5	11	15	18.5	22
	For ND setting	0.75	1.5	2.2	3	4	5.5	7.5	11	15	18.5	22	30
Output characteristics ²	Max output current (A) □-EF	3.8	6.0	9.0	11.3	14.3	19.5	27.0	39.0	46.0	55.0	69.0	92.0
	Max output current (A) □-EV	3.0	4.8	7.2	9.0	11.4	15.6	21.6	31.0	37.0	44.0	55.0	73.0
	Rated output current (A) at HD	2.0	3.2	4.8	6.0	7.6	10.4	14.4	21.0	25.0	29.6	37.0	49.0
	Rated output current (A) at ND	2.5	4.0	6.0	7.5	9.5	13.0	18.0	26.0	31.0	37.0	46.0	61.0
	Output voltage	0 to Mains supply voltage											
	Max. output frequency	599 Hz											
Power supply	Rated input voltage and frequency	3-phase 230 to 480 V 50/60 Hz											
	Allowable voltage fluctuation	+10% to -15% (-10% at 230V)											
	Allowable frequency fluctuation	45 to 65 Hz											

¹ Based on a standard 4-pole motor for maximum applicable motor output

² Values for IP54 models, IP20 ones has slightly different current ratings

Three-phase: SX-□4□□□-E□		037	045	055	075	090	110	132	160	200	220	250	315
Motor kW ¹	For HD setting	30	37	45	55	75	90	110	132	160	200	220	250
	For ND setting	37	45	55	75	90	110	132	160	200	220	250	315
Output characteristics ²	Max output current (A) □-EF	111	108	131	175	210	252	300	360	450	516	600	720
	Max output current (A) □-EV	89.0	108	131	175	210	252	300	360	450	516	600	720
	Rated output current (A) at HD	59.0	72.0	87.0	117	140	168	200	240	300	344	400	480
	Rated output current (A) at ND	74.0	90.0	109	146	175	210	250	300	365	430	500	600
	Output voltage	0 to Mains supply voltage											
	Max. output frequency	599 Hz											
Power supply	Rated input voltage and frequency	3-phase 230 to 480 V 50/60 Hz											
	Allowable voltage fluctuation	+10% to -15% (-10% at 230V)											
	Allowable frequency fluctuation	45 to 65 Hz											

¹ Based on a standard 4-pole motor for maximum applicable motor output

² For units up to 200KW the IP20 output current ratings are slightly different

Three-phase: SX-□4□□□-E□		355	400	450	500	630	710	800	900	1K1	1K2	1K4	
Motor kW ¹	For HD setting	315	355	400	450	500	560	630	800	900	1000	1120	
	For ND setting	355	400	450	500	630	710	800	900	1120	1250	1400	
Output characteristics	Max output current (A) □-EF	780	900	1032	1200	1440	1500	1800	2100	2400	2700	3000	
	Max output current (A) □-EV	780	900	1032	1200	1440	1500	1800	2100	2400	2700	3000	
	Rated output current (A) at HD	520	600	688	800	960	1000	1200	1400	1600	1800	2000	
	Rated output current (A) at ND	650	750	860	1000	1200	1250	1500	1750	2000	2250	2500	
	Output voltage	0 to Mains supply voltage											
	Max. output frequency	599 Hz											
Power supply	Rated input voltage and frequency	3-phase 230 to 480 V 50/60 Hz											
	Allowable voltage fluctuation	+10% to -15% (-10% at 230V)											
	Allowable frequency fluctuation	45 to 65 Hz											

¹ Based on a standard 4-pole motor for maximum applicable motor output

Common specifications

Model number SX-	Specifications	
Control functions	Motor control	AC motor, PM motor
	Control methods	V/f control for "V" type V/f control, Vector control with or without feedback for the "F" type
	Output frequency range	0.0 to 599 Hz
	Frequency tolerance	Analogue set value: 1% + 1.5 LSB fsd
	Resolution of frequency set value	Digital set value: 0.1 Hz Analogue set value: 0.03 Hz / 60 Hz (11 bit + sign)
	Resolution of output frequency	0.1 Hz
	Frequency set value	-10 to +10 V (40 kΩ), 0 to 20 mA (252 Ω), frequency setting value (selectable)
	Starting Torque	150% for Heavy duty, 120% for Normal duty
	Torque static accuracy	<3% in Vector control with feedback <3% in vector control without feedback if speed between 10 and 100%, <10% at 0 Hz
	Torque response	1 ms for 0 to 90% speed 5 ms for 90 to 100% speed (Close and open loop)
	Speed Control Accuracy	V/f control 1% Vector control without feedback 0.1% Vector control with feedback 0.01%
	Speed Response	0.4% without encoder feedback 0.2% with encoder feedback
	Torque Limit	From Analog input
	Accel/Decel Time	0.0 to 3600.0 s
Braking torque	5% to 10% (100% with external braking resistor)	
Functionality	Main Control Functions PID, sleep function, brake control, torque control (Direct torque control model), Pump/Fan control, Logic functions, virtual connections, overvoltage control, undervoltage override, autoreset, two motor support, Lim Switch, External trip, Preset Speeds, MotPot Up Down, Pump Feedback, Timer, Mot PreMag , Jog, Ext Mot Temp, Loc/Rem, AnIn select, Brk Ackn.	
Protection functions	Motor protection	Motor overheat protection based on output current or PTC by option board
	Momentary overcurrent Protection	Drive stops when output current exceeds 200% of peak current
	Overload Protection	Drive stops after 1 min at 150% of rated output current (Heavy Duty Rating) Drive stops after 1 min at 120% of rated output current (Normal Duty Rating) (1 min every 10 min)
	Overvoltage Protection	Line Overvoltage: 760 VDC during more than 10 s for 400 V class; Fast Overvoltage: 850 VDC for 400 V class
	Undervoltage Protection	400 VDC for 400 V class (Adjustable by input power supply parameter)
	Momentary power loss Ride-Thru	Low voltage override function
	Heatsink Overheat Protection	Protected by thermister
	Braking Resistance Overheat Protection	Hardware short circuit protection
	Stall prevention	Current limit function
Power charge indication	Power LED remains lit until capacitors are charged	
Ambient conditions	Ambient Temperature	0 to 40°C, up to 45°C with derating
	Ambient humidity	90% RH or less (without condensation)
	Storage temperature	-20 to 60°C (short-term temperature during transportation)
	Altitude	Up to 1000 meters (output derating of 1% per 100 m above 1000 m, max. 2000 m)
	Vibration / Shock	According to IEC 60068-2-6, Sinusoidal vibrations: 10<f<57 Hz, 0.075 mm, 57<f<150 Hz, 1g
	Contamination, according to IEC 60721-3-3	No electrically conductive dust allowed. Cooling air must be clean and free from corrosive materials. Chemical gases, class 3C2. Solid particles, class 3S2
Protection Design	IP54 enclosure according to the EN 60529	

Dimensions

IP54 models

Inverter model	Frame	Dimensions in mm		
		H	W	D
SX-D40P7 to D47P5	B	350/416 ^{*1}	203	200
SX-D4011 to D4022	C	440/512 ^{*1}	178	292
SX-D4030 to D4037	D	545/590 ^{*1}	220	295
SX-D4045 to D4090	E	950	285	314
SX-D4110 to D4160	F		345	
SX-D4200	FA	1395		365
SX-D4220 to D4250	H	2250	600	600
SX-D4315 to D4400	I		900	
SX-D4450 to D4500	J		1200	
SX-D4630 to D4710	KA		1500	
SX-D4800	K		1800	
SX-D4900	L		2100	
SX-D41K1	M		2400	
SX-D41K2	N		2700	
SX-D41K4	O		3000	

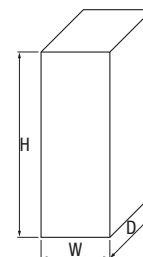

*1 Enclosure height/Total height.

IP20 models

Inverter model	Frame	Dimensions in mm		
		H	W	D
SX-A4220 to A4250	H	1036	500	450
SX-A4315 to A4400	I		730	
SX-A4450 to A4500	J		1100	
SX-A4630 to A4710	KA		1365	
SX-A4800	K		1630	
SX-A4900	L		2000	
SX-A41K1	M		2230	
SX-A41K2	N		2530	
SX-A41K4	O		2830	

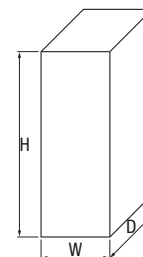

Weight and Air flow

Model SX-	Weight (Kg)		Air flow (m ³ /hour)
	SX-D (IP54)	SX-A (IP20)	
0P7 to 7P5	12.5	–	75
011 to 015	24	–	120
018 to 022	24	–	170
030 to 037	32	–	
045 to 055	56	–	510
075 to 090	60	–	
110 to 160	75	–	800
200	95	–	1020
220 to 250	380	170	1600
315 to 400	506	248	2400
450 to 500	697	340	3200
630 to 710	838	418	4000
800	987	496	4800
900	1190	588	5600
1K1	1323	666	6400
1K2	1518	744	7200
1K4	1772	836	8000

LCD operator



Output coils

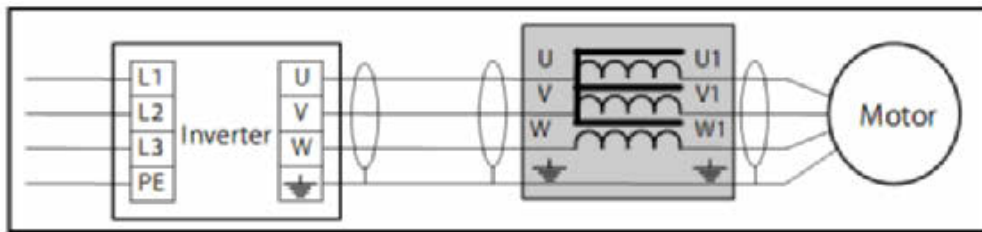
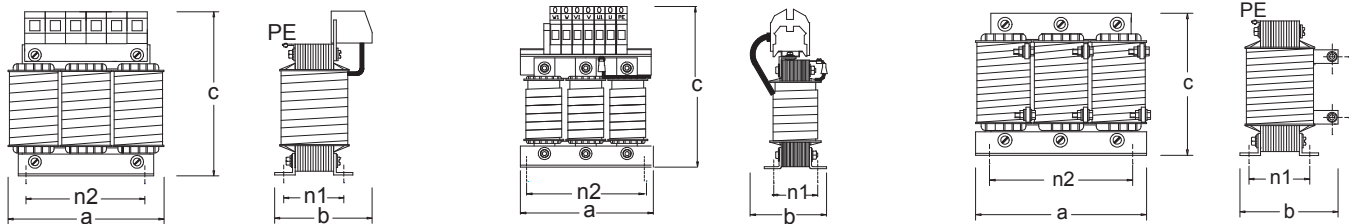

Figure 1

Figure 2

Figure 3



Type	Fig	a	b	c	n2	n1	Fix	Weight	Connection	
473160 00	1	78	60	95	50	31	M4	0.6 kg	2.5 mm ²	
473161 00										
473162 00										
473163 00										
473164 00										
473165 00										
473166 00	2	96	74	105	71	48	M4	1.2 kg	4 mm ²	
473167 00										
473168 00										
473169 00	3	210	120	235	175	66	M6	8.4 kg	35 mm ²	
473170 00			140	260		77				
473171 00			160	180		97				13.4 kg
473172 00			170	200		95				
473173 00	3	230	170	200	175	95	M6	18.4 kg	M10	
473174 00										240

Standard connections

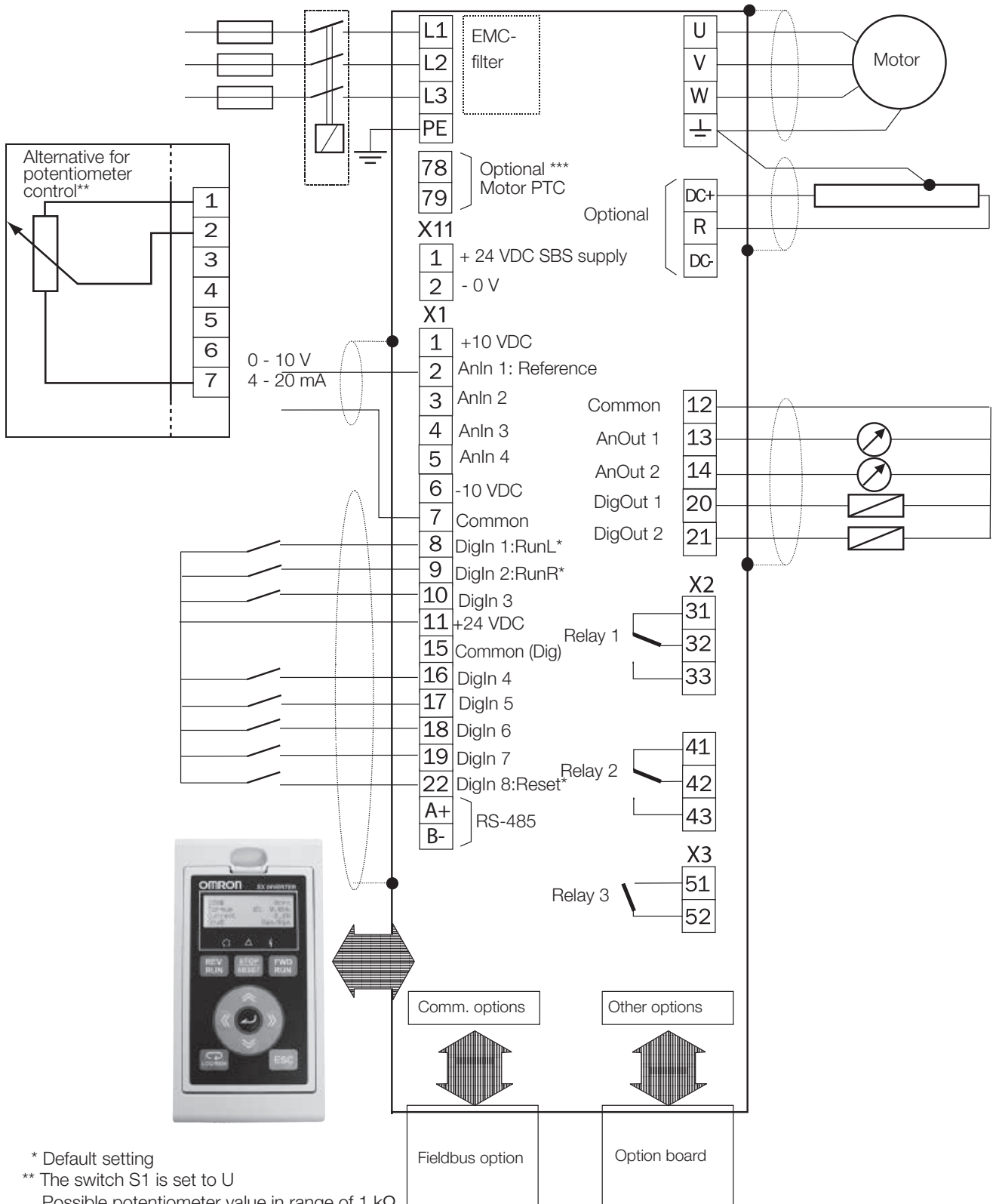

* Default setting

** The switch S1 is set to U

Possible potentiometer value in range of 1 kΩ to 10 kΩ (1/4 Watt) linear, where we advise to use a linear 1 kΩ / 1/4 W type potentiometer for best control linearity.

*** Optional terminals X1: 78 - 79 for connection of Motor-PTC on frame sizes B, C and D.

Main circuit

Terminal	Name	Function (signal level)
L1, L2, L3	Main circuit power supply input	Used to connect line power to the drive.
U, V, W	Inverter output	Used to connect the motor
DC-, DC+, R	DC link connections, Brake resistor	The brake resistor must be connected terminals DC+ and R (Terminals are only fitted if the Brake Chopper Option is built-in)
PE	Safety earth	Protected earth
⊕	Grounding	Motor earth

Control Circuit

Type	No.	Signal name	Function	Signal level
Digital input signals	8	DigIn 1	RunL (reverse)	High > 9 VDC Low < 4 VDC Max 30 VDC Impedance 4.7 kΩ for < 3.3 VDC 3.6 kΩ for > 3.3 VDC
	9	DigIn 2	RunR (forward)	
	10	DigIn 3	Off	
	16	DigIn 4	Off	
	17	DigIn 5	Off	
	18	DigIn 6	Off	
	19	DigIn 7	Off	
	22	DigIn 8	RESET	
	11	+24 V	+24 VDC supply voltage	Max 100 mA
15	Common	Signal ground		
Analog input signals	1	+10 V	+10 VDC supply voltage	-10 to 10 VDC 0 to 20mA Max 30 V/30 mA Impedance 20 kΩ Voltage 250 Ω Current
	2	AnIn 1	Process Ref	
	3	AnIn 2	Off	
	4	AnIn 3	Off	
	5	AnIn 4	Off	
	6	-10 V	-10 VDC supply voltage	
	7	Common	Signal ground	
Digital output signals	20	DigOut 1	Ready	High > 20 VDC @ 50 mA > 23 VDC open Low <1 VDC @ 50 mA 100 mA max together with +24 VDC
	21	DigOut 2	Brake	
	12	Common	Signal ground	
	31	N/C 1	Relay 1 output Trip, active when the VSD is in a TRIP condition.	0.1 to 2A 250 VAC or 42 VDC
	32	COM 1		
	33	N/O 1		
	41	N/C 2	Relay 2 output Run, active when the VSD is started.	
	42	COM 2		
43	N/O 2			
51	COM 3	Relay 3 output Off		
52	N/O 3			
Analog output signals	12	Common	Signal ground	0 to 10 V/0 to 20 mA Max -13 V @ 5 mA Impedance: 10 Ω (Voltage)
	13	AnOut1	Min speed to max speed	
	14	AnOut2	0 to max torque	
RS-485	A+	A+	RS-485 Differential transmit and receive	
	B-	B-		
SBS supply	1	+	External Standby power supply terminals	24 VDC ±10%
	2	-		0 V

Ordering information

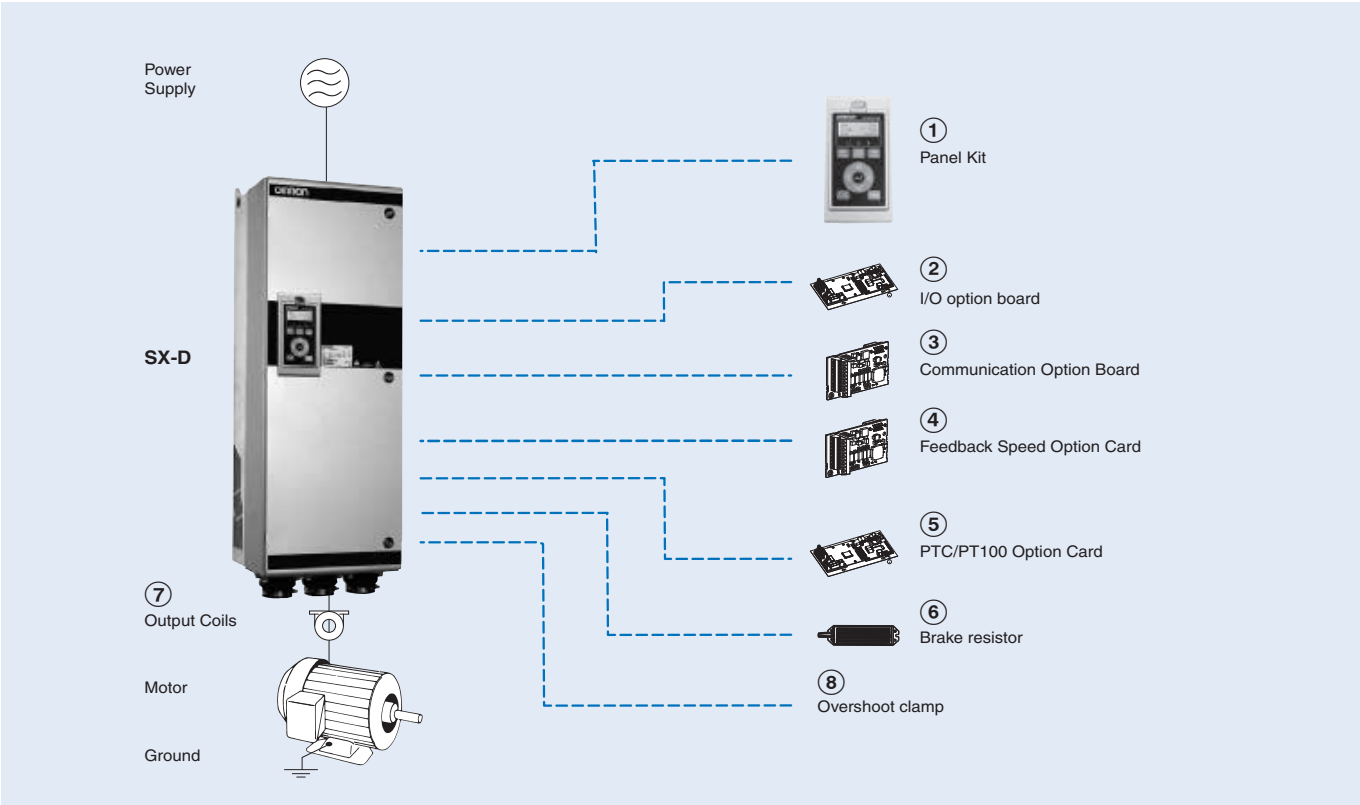

SX

Specifications				IP54 Model		IP20 Model				
Voltage	Heavy Duty		Normal Duty		Direct torque control	V/F	Direct torque control	V/F		
400 V	0.55 kW	2.0 A	0.75 kW	2.5 A	SX-D40P7-EFA4	SX-D40P7-EVA4	-	-		
	1.1 kW	3.2 A	1.5 kW	4.0 A	SX-D41P5-EFA4	SX-D41P5-EVA4				
	1.5 kW	4.8 A	2.2 kW	6.0 A	SX-D42P2-EFA4	SX-D42P2-EVA4				
	2.2 kW	6.0 A	3 kW	7.5 A	SX-D43P0-EFA4	SX-D43P0-EVA4				
	3 kW	7.6 A	4 kW	9.5 A	SX-D44P0-EFA4	SX-D44P0-EVA4				
	4 kW	10.4 A	5.5 kW	13 A	SX-D45P5-EFA4	SX-D45P5-EVA4				
	5.5 kW	14.4 A	7.5 kW	18 A	SX-D47P5-EFA4	SX-D47P5-EVA4				
	7.5 kW	21 A	11 kW	26 A	SX-D4011-EFA4	SX-D4011-EVA4			SX-A4011-EFA4	SX-A4011-EVA4
	11 kW	25 A	15 kW	31 A	SX-D4015-EFA4	SX-D4015-EVA4			SX-A4015-EFA4	SX-A4015-EVA4
	15 kW	29.6 A	18.5 kW	37 A	SX-D4018-EFA4	SX-D4018-EVA4			SX-A4018-EFA4	SX-A4018-EVA4
	18.5 kW	37 A	22 kW	46 A	SX-D4022-EFA4	SX-D4022-EVA4			SX-A4022-EFA4	SX-A4022-EVA4
	22 kW	49 A	30 kW	61 A	SX-D4030-EFA4	SX-D4030-EVA4			SX-A4030-EFA4	SX-A4030-EVA4
	30 kW	59 A	37 kW	74 A	SX-D4037-EFA4	SX-D4037-EVA4	SX-A4037-EFA4	SX-A4037-EVA4		
	37 kW	72 A	45 kW	90 A	SX-D4045-EFA4	SX-D4045-EVA4	SX-A4045-EFA4	SX-A4045-EVA4		
	45 kW	87 A	55 kW	109 A	SX-D4055-EFA4	SX-D4055-EVA4	SX-A4055-EFA4	SX-A4055-EVA4		
	55 kW	117 A	75 kW	146 A	SX-D4075-EFA4	SX-D4075-EVA4	SX-A4075-EFA4	SX-A4075-EVA4		
	75 kW	140 A	90 kW	175 A	SX-D4090-EFA4	SX-D4090-EVA4	SX-A4090-EFA4	SX-A4090-EVA4		
	90 kW	168 A	110 kW	210 A	SX-D4110-EFA4	SX-D4110-EVA4	SX-A4110-EFA4	SX-A4110-EVA4		
	110 kW	200 A	132 kW	250 A	SX-D4132-EFA4	SX-D4132-EVA4	SX-A4132-EFA4	SX-A4132-EVA4		
	132 kW	240 A	160 kW	300 A	SX-D4160-E3FA4	SX-D4160-E3VA4	SX-A4160-E3FA4	SX-A4160-E3VA4		
	160 kW	300 A	200 kW	365 A	SX-D4200-E3FA4	SX-D4200-E3VA4	SX-A4200-E3FA4	SX-A4200-E3VA4		
	200 kW	344 A	220 kW	430 A	SX-D4220-E1FA4	SX-D4220-E1VA4	SX-A4220-EFA4	SX-A4220-EVA4		
	220 kW	400 A	250 kW	500 A	SX-D4250-E1FA4	SX-D4250-E1VA4	SX-A4250-EFA4	SX-A4250-EVA4		
	250 kW	480 A	315 kW	600 A	SX-D4315-E1FA4	SX-D4315-E1VA4	SX-A4315-EFA4	SX-A4315-EVA4		
315 kW	520 A	355 kW	650 A	SX-D4355-E1FA4	SX-D4355-E1VA4	SX-A4355-EFA4	SX-A4355-EVA4			
355 kW	600 A	400 kW	750 A	SX-D4400-E1FA4	SX-D4400-E1VA4	SX-A4400-EFA4	SX-A4400-EVA4			
400 kW	688 A	450 kW	860 A	SX-D4450-E1FA4	SX-D4450-E1VA4	SX-A4450-EFA4	SX-A4450-EVA4			
450 kW	800 A	500 kW	1000 A	SX-D4500-E1FA4	SX-D4500-E1VA4	SX-A4500-EFA4	SX-A4500-EVA4			
500 kW	960 A	630 kW	1200 A	SX-D4630-E1FA4	SX-D4630-E1VA4	SX-A4630-EFA4	SX-A4630-EVA4			
560 kW	1000 A	710 kW	1250 A	SX-D4710-E1FA4	SX-D4710-E1VA4	SX-A4710-EFA4	SX-A4710-EVA4			
630 kW	1200 A	800 kW	1500 A	SX-D4800-E1FA4	SX-D4800-E1VA4	SX-A4800-EFA4	SX-A4800-EVA4			
800 kW	1400 A	900 kW	1750 A	SX-D4900-E1FA4	SX-D4900-E1VA4	SX-A4900-EFA4	SX-A4900-EVA4			
900 kW	1600 A	1120 kW	2000 A	SX-D1K1-E1FA4	SX-D1K1-E1VA4	SX-A1K1-EFA4	SX-A1K1-EVA4			
1000 kW	1800 A	1250 kW	2250 A	SX-D1K2-E1FA4	SX-D1K2-E1VA4	SX-A1K2-EFA4	SX-A1K2-EVA4			
1120 kW	2000 A	1400 kW	2500 A	SX-D1K4-E1FA4	SX-D1K4-E1VA4	SX-A1K4-EFA4	SX-A1K4-EVA4			

① Panel Kit

Type	Model	Description	Function
Panel kit	SX-OP04K-00-E	Panel kit	Complete panel kit including 4-lines operator (frame D and higher)
	SX-OP02-00-E		Complete panel kit including 2-lines operator
	SX-OP04K-51-E	Blank panel kit	Complete panel kit including a blank operator (frame D and higher)
	SX-OP04K-71-E		Complete panel kit including a blank operator (frame B)
	SX-OP04K-81-E		Complete panel kit including a blank operator (frame C)
Operator	SX-OPHH-00-E	Handheld control panel	Complete handheld control panel
	SX-OP04-00-E	Digital operator	Inverter digital 4-lines operator
	SX-OP01-00-E		Inverter digital 2-lines operator
	SX-OP01-11-E	Blank operator	Blank operator

② I/O option board

Model	Description	Function
01-3876-01	Additional I/O option	Provides 3 extra relay outputs and 3 additional digital inputs
01-3876-07	Crane option	Dedicated option board for crane application, including additional I/O and functions

③ Communication option board

Type	Model	Description	Function
Communication option board	01-3876-04	RS232/485	MODBUS RTU serial communication by RS232 or RS485 interface with galvanic isolation
	01-3876-05	PROFIBUS-DP	Used for operating the inverter through PROFIBUS-DP communication with the host controller.
	01-3876-06	DeviceNet	Used for operating the inverter through DeviceNet communication with the host controller.
	01-3876-09	Modbus/TCP, Ethernet	Used for operating the inverter through Modbus/TCP communication with the host controller.
	01-3876-10	EtherCAT	Used for operating the inverter through EtherCAT communication with the host controller.
	01-3876-11	PROFINET (1-port)	Used for operating the inverter through PROFINET communication with the host controller.
	01-3876-12	PROFINET (2-ports)	
	01-3876-13	EtherNet/IP (2-ports)	Used for operating the inverter through EtherNet/IP communication with the host controller.

④ Encoder feedback option card

Model	Description	Function
01-3876-03	Encoder option	Used for connection of the actual motor speed via encoder. Up to 100 kHz with TTL and HTL incremental encoders with 5/24 V power supply

⑤ PTC/PT100 option card

Model	Description	Function
01-3876-08	Thermal protection	Allows to connect a motor thermistor to the inverter

⑥ Braking chopper and braking resistor

All inverter sizes could be fitted with an optional built-in brake chopper from factory but is not possible to install it later. The choice of the resistor depends on the application switch-on duration and duty-cycle. Following tables describes the activation level of the built-in braking chopper and the minimum resistor that could be used depending on the input voltage.

Type	R for different input voltage (Ω)			Type	R for different input voltage (Ω)		
	220 to 240 VAC	380 to 415 VAC	440 to 480 VAC		220 to 240 VAC	380 to 415 VAC	440 to 480 VAC
SX-40P7	43	43	50	SX-4132	2.7	2.7	3.1
SX-41P5	43	43	50	SX-4160	2 × 3.8	2 × 3.8	2 × 4.4
SX-42P2	43	43	50	SX-4200	2 × 3.8	2 × 3.8	2 × 4.4
SX-43P0	43	43	50	SX-4220	2 × 2.7	2 × 2.7	2 × 3.1
SX-44P0	43	43	50	SX-4250	2 × 2.7	2 × 2.7	2 × 3.1
SX-45P5	43	43	50	SX-4315	3 × 2.7	3 × 2.7	3 × 3.1
SX-47P5	43	43	50	SX-4355	3 × 2.7	3 × 2.7	3 × 3.1
SX-4011	26	26	30	SX-4400	3 × 2.7	3 × 2.7	3 × 3.1
SX-4015	26	26	30	SX-4450	4 × 2.7	4 × 2.7	4 × 3.1
SX-4018	17	17	20	SX-4500	4 × 2.7	4 × 2.7	4 × 3.1
SX-4022	17	17	20	SX-4630	6 × 2.7	6 × 2.7	6 × 3.1
SX-4030	9.7	9.7	N/A	SX-4710	5 × 2.7	5 × 2.7	5 × 3.1
SX-4037	9.7	9.7	N/A	SX-4800	6 × 2.7	6 × 2.7	6 × 3.1
SX-4045	3.8	3.8	4.4	SX-4900	7 × 2.7	7 × 2.7	7 × 3.1
SX-4055	3.8	3.8	4.4	SX-1K1	8 × 2.7	8 × 2.7	8 × 3.1
SX-4075	3.8	3.8	4.4	SX-1K2	9 × 2.7	9 × 2.7	9 × 3.1
SX-4090	3.8	3.8	4.4	SX-1K4	10 × 2.7	10 × 2.7	10 × 3.1
SX-4110	2.7	2.7	3.1		-	-	-

Supply voltage (VAC)	Built-in brake chopper trigger level (VDC)
220 to 240	380
380 to 415	660
440 to 480	780

⑦ Output coils

Output coils above SX-4200-E should be order from factory as they should be installed inside of the cabinet

Voltage	Inverter model	Model	Rated current	Inductance	Rated Voltage	Max carrier	Max output frequency	Max temp
400V	SX-40P7-E	473160 00	2.8A	1.5 mH	800 V	10 kHz	200 Hz	40°C
	SX-41P5-E	473161 00	4.4A	1.0 mH				
	SX-42P2-E	473162 00	6.6A	0.65 mH				
	SX-43P0-E	473163 00	11.0A	0.4 mH				
	SX-44P0-E							
	SX-45P5-E	473164 00	14.3A	0.3 mH				
	SX-47P5-E	473165 00	18.2A	0.25 mH				
	SX-4011-E	473166 00	26.4A	0.175 mH				
	SX-4015-E	473167 00	32A	0.15 mH				
	SX-4018-E	473168 00	65A	0.1 mH				
	SX-4022-E							
	SX-4030-E							
	SX-4037-E	473169 00	90A	0.1 mH				
	SX-4045-E							
	SX-4055-E	473170 00	146A	0.05 mH				
	SX-4075-E							
	SX-4090-E	473171 00	175A	0.05 mH				
	SX-4110-E	473172 00	275A	0.032 mH				
SX-4132-E								
SX-4160-E	473173 00	320 A	0.025 mH					
SX-4200-E	473174 00	410 A	0.021 mH					
						1.5 kHz	100 Hz	

⑧ Overshoot clamp

Only two types of overshoot clamps could be order for after mounting

Model	Inverter	Function
52163	SX-40P7 to SX-4200	Together with the output coils, the overshoot clamp restricts the voltage and the dV/dt on the motor winding. Inverters must be ordered including the option DC+/DC- connectors.
52220	SX-4220 to SX-4800	Together with the output coils, the overshoot clamp restricts the voltage and the dV/dt on the motor winding. Doesn't require the "DC+/DC-" option.

Computer software

Types	Model	Description	Installation
Software	CX-Drive	Computer software	Configuration and monitoring software tool
	CX-One	Computer software	Configuration and monitoring software tool
	€Saver	Computer software	Software tool for Energy Saving calculation

ALL DIMENSIONS SHOWN ARE IN MILLIMETERS.
To convert millimeters into inches, multiply by 0.03937. To convert grams into ounces, multiply by 0.03527.