

R88L-EC-FW/GW-□

# Accurax linear motor

## New linear motors with optimised efficiency

Iron-core motors for high speed and high duty cycle operations and Ironless motors for cogging-free and high dynamic applications. Both motor and families deliver unparalleled accuracy and performance benefits.

- Ironless and iron-core types available
- High dynamic and precise positioning
- Compact and flat design iron-core motors
- Excellent force-to-weight ratio ironless motors
- Weight-optimised magnet track
- Optional digital hall-sensor and connectors
- Temperature sensors included

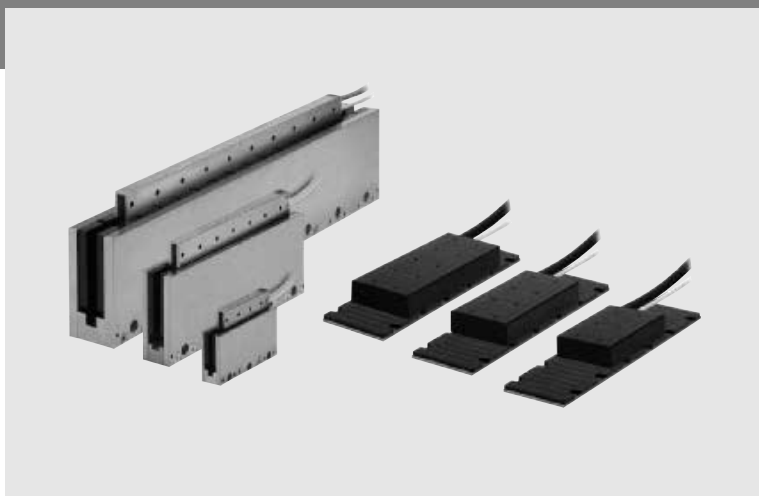

## Ratings

- Iron-core motors - 48 to 760 N (2000 N peak force)
- Ironless motors - 29 to 423 N (2100 N peak force)

## System configuration

(Refer to servo drive chapter)

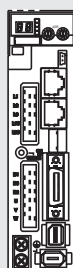

**SYNMAC**  
always in control

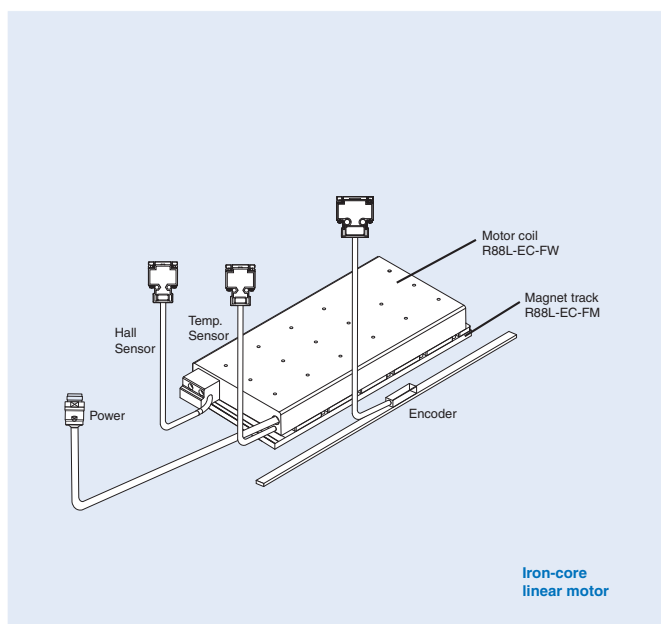
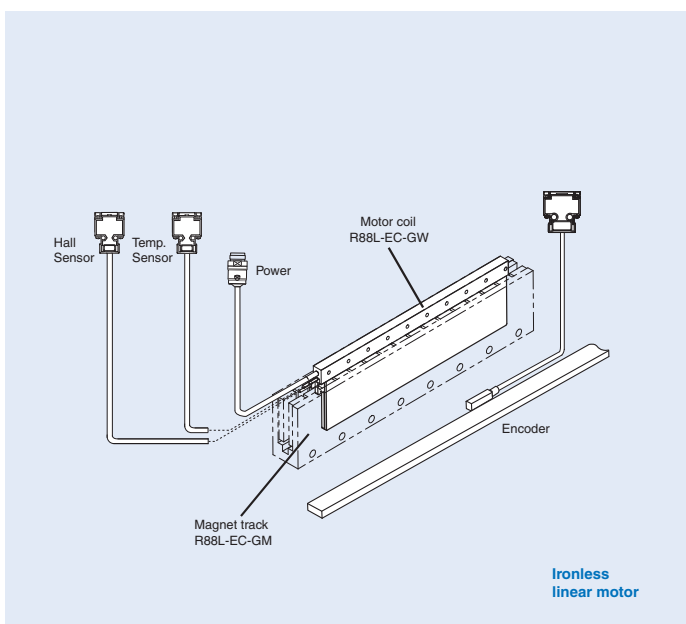

Accurax G5 servo drive  
EtherCAT model



Linear motor / Servo drive combination

Linear motor coil				Linear Servo drive			
Type	Rated force	Peak force	Model	Accurax G5 EtherCAT model			
				230V	400V		
R88L-EC-FW-□ Iron-core motors  230 V/400 V	48 N	105 N	Coil without connectors	R88L-EC-FW-0303-ANPC	R88D-KN02H-ECT-L	R88D-KN06F-ECT-L	
	96 N	210 N		R88L-EC-FW-0306-ANPC	R88D-KN04H-ECT-L	R88D-KN10F-ECT-L	
	160 N	400 N		R88L-EC-FW-0606-ANPC	R88D-KN08H-ECT-L	R88D-KN15F-ECT-L	
	240 N	600 N		R88L-EC-FW-0609-ANPC	R88D-KN10H-ECT-L	R88D-KN20F-ECT-L	
	320 N	800 N		R88L-EC-FW-0612-ANPC	R88D-KN15H-ECT-L	R88D-KN30F-ECT-L	
	608 N	1600 N		R88L-EC-FW-1112-ANPC	R88D-KN15H-ECT-L	R88D-KN30F-ECT-L	
	760 N	2000 N		R88L-EC-FW-1115-ANPC	R88D-KN15H-ECT-L	R88D-KN30F-ECT-L	
	230 V/400 V	48 N	105 N	Coil with connectors	R88L-EC-FW-0303-APLC	R88D-KN02H-ECT-L	R88D-KN06F-ECT-L
		96 N	210 N		R88L-EC-FW-0306-APLC	R88D-KN04H-ECT-L	R88D-KN10F-ECT-L
		160 N	400 N		R88L-EC-FW-0606-APLC	R88D-KN08H-ECT-L	R88D-KN15F-ECT-L
		240 N	600 N		R88L-EC-FW-0609-APLC	R88D-KN10H-ECT-L	R88D-KN20F-ECT-L
		320 N	800 N		R88L-EC-FW-0612-APLC	R88D-KN15H-ECT-L	R88D-KN30F-ECT-L
		608 N	1600 N		R88L-EC-FW-1112-APLC	R88D-KN15H-ECT-L	R88D-KN30F-ECT-L
		760 N	2000 N		R88L-EC-FW-1115-APLC	R88D-KN15H-ECT-L	R88D-KN30F-ECT-L
R88L-EC-GW-□ Ironless motors  230 V	29 N	100 N	Coil without connectors	R88L-EC-GW-0303-ANPS	R88D-KN02H-ECT-L	-	
	58 N	200 N		R88L-EC-GW-0306-ANPS	R88D-KN08H-ECT-L	-	
	87 N	300 N		R88L-EC-GW-0309-ANPS	R88D-KN10H-ECT-L	-	
	70 N	240 N		R88L-EC-GW-0503-ANPS	R88D-KN02H-ECT-L	-	
	140 N	480 N		R88L-EC-GW-0506-ANPS	R88D-KN04H-ECT-L	-	
	210 N	720 N		R88L-EC-GW-0509-ANPS	R88D-KN08H-ECT-L	-	
	141 N	700 N		R88L-EC-GW-0703-ANPS	R88D-KN04H-ECT-L	-	
	282 N	1400 N		R88L-EC-GW-0706-ANPS	R88D-KN08H-ECT-L	-	
	423 N	2100 N		R88L-EC-GW-0709-ANPS	R88D-KN10H-ECT-L	-	
	230 V	29 N		100 N	Coil with connectors	R88L-EC-GW-0303-APLS	R88D-KN02H-ECT-L
		58 N	200 N	R88L-EC-GW-0306-APLS		R88D-KN08H-ECT-L	-
		87 N	300 N	R88L-EC-GW-0309-APLS		R88D-KN10H-ECT-L	-
		70 N	240 N	R88L-EC-GW-0503-APLS		R88D-KN02H-ECT-L	-
		140 N	480 N	R88L-EC-GW-0506-APLS		R88D-KN04H-ECT-L	-
		210 N	720 N	R88L-EC-GW-0509-APLS		R88D-KN08H-ECT-L	-
		141 N	700 N	R88L-EC-GW-0703-APLS		R88D-KN04H-ECT-L	-
		282 N	1400 N	R88L-EC-GW-0706-APLS		R88D-KN08H-ECT-L	-
		423 N	2100 N	R88L-EC-GW-0709-APLS		R88D-KN10H-ECT-L	-

Type designation

Linear motor coil

R88L-EC-FW-0303-ANPC

Accurax linear motor component

Motor type	
Code	Specifications
FW	Iron-core motor coil
GW	Ironless motor coil

Magnet width	
Code	Specifications
03	30 mm active magnet width
05	50 mm active magnet width
06	60 mm active magnet width
07	70 mm active magnet width
11	110 mm active magnet width

Coil model	
Code	Specifications
03	3-coil model
06	6-coil model
09	9-coil model
12	12-coil model
15	15-coil model

Motor series	
Code	Specifications
C	Compact (Iron-core models)
S	Standard (Ironless models)

Connector options	
Code	Specifications
NP	No connectors
PL	With connectors

Design Revision No.

Magnet track

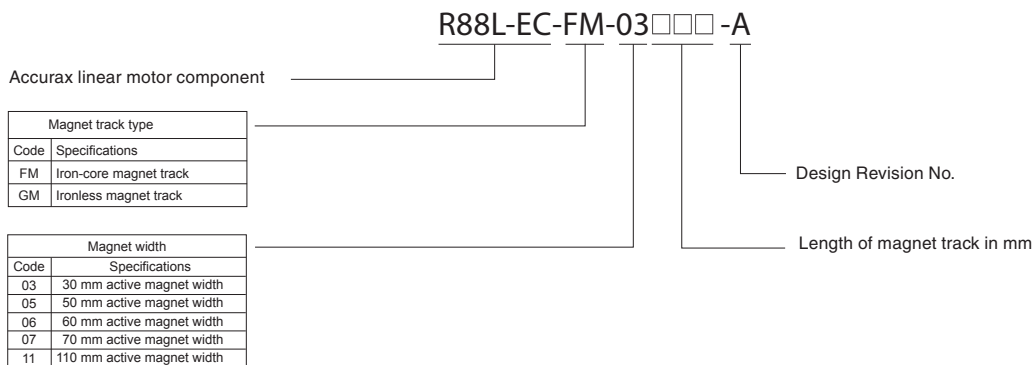

Hall sensor

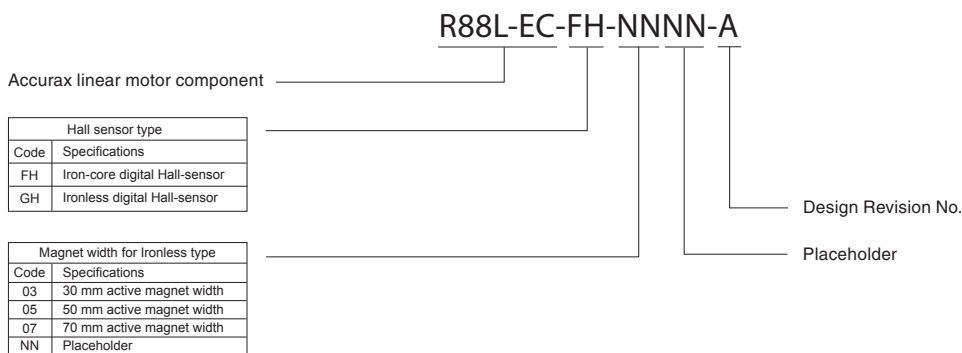

Linear servomotor specifications

Iron-core motors R88L-EC-FW-□ (230/400 VAC)

Voltage	R88L-EC-FW-□	230/400V						
		0303-□	0306-□	0606-□	0609-□	0612-□	1112-□	1115-□
Linear motor model	R88L-EC-FW-□							
Maximum speed (100 V)	m/s	2,5		2			1	
Maximum speed (200 V)	m/s	5		4			2	
Maximum speed (400 V)	m/s	10		8			4	
Peak force <sup>1</sup>	N	105	210	400	600	800	1600	2000
Peak current <sup>1</sup>	Arms	3.1	6.1	10	15	20	20	25
Continuous force <sup>2</sup>	N	48	96	160	240	320	608	760
Continuous current <sup>2</sup>	Arms	1.24	2.4	3.4	5.2	6.9	6.5	8.2
Motor force constant	N/A <sub>rms</sub>	39.7		46.5			93	
BEMF	V/m/s	32		38			76	
Motor constant	N/√W	9.75	13.78	19.49	23.87	27.57	41.47	46.37
Phase resistance	Ω	5.34	2.68	1.83	1.23	0.92	1.6	1.29
Phase Inductance	mH	34.7	17.4	13.7	9.2	6.9	12.8	10.3
Electrical time constant	ms	6.5		7.5			8	
Max. cont. power dissipation (all coils)	W	32	63	88	131	175	279	349
Thermal resistance	K/W	2.20	1.10	0.78	0.52	0.39	0.23	0.18
Thermal time constant	s	110		124			126	
Magnetic attraction force	N	300	500	1020	1420	1820	3640	4440
Magnet pole pitch	mm	24						
Weight coil unit <sup>3</sup>	kg	0.48	0.78	1.31	1.84	2.37	4.45	5.45
Weight magnet track	kg/m	2.1		3.8			10.5	
Dimension cooling plate (l x w x h)	mm	238x220x10			250x287x12		371x330x14	
Protection methods <sup>4</sup>	Temperature sensors (KTY-83/121 & PTC 110C), self cooling							
Hall sensor	Digital (optional)							
Insulation class	Class B							
Max. bus voltage	560 VDC							
Insulation resistance	500 VDC, min. 10 MΩ							
Di-electric strength	2750V for 1sec							
Max. allowable coil temperature	130°C							
Ambient humidity	20 to 80% (non-condensing)							
Max. allowable magnet temperature	70°C							

<sup>1</sup> Coil temperature rising by 6K/s.

<sup>2</sup> Values at 100°C coil temperature and magnets at 25°C. Coil unit must be attached to the given cooling plate sizes in the table and an airstream of 2.5 m/s (25°C) has to be applied.

<sup>3</sup> Weight without connector and cable.

<sup>4</sup> I<sup>2</sup>t has to be set properly for high current applications.

All other values at 25°C (±10%).

## Force-speed characteristics

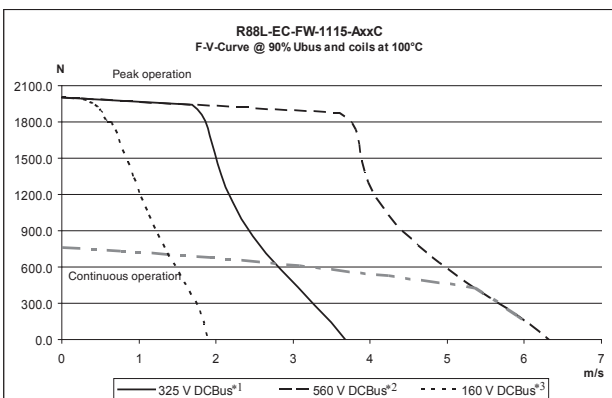
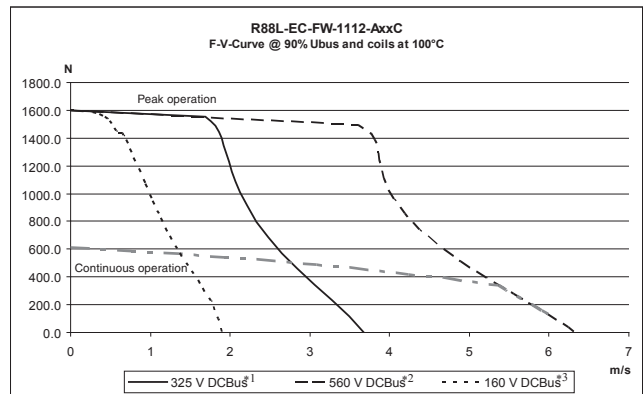
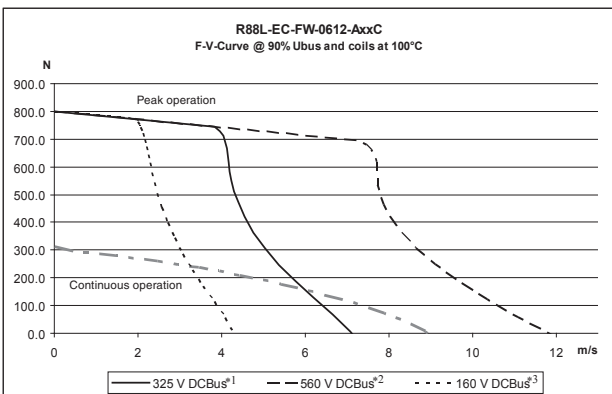
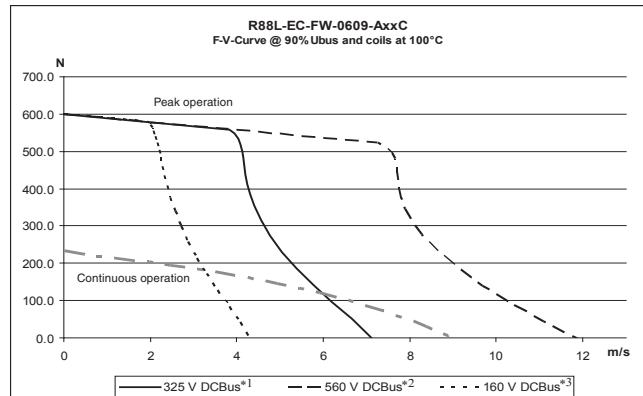
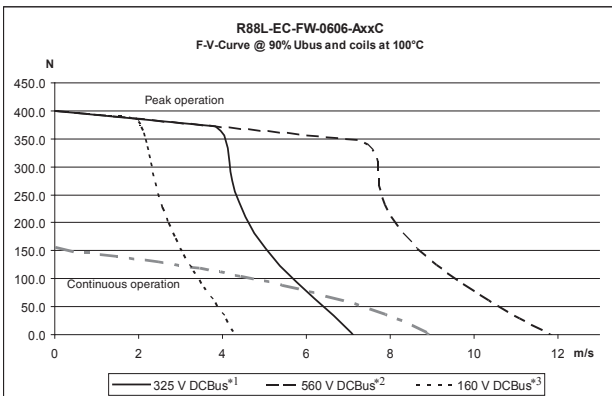
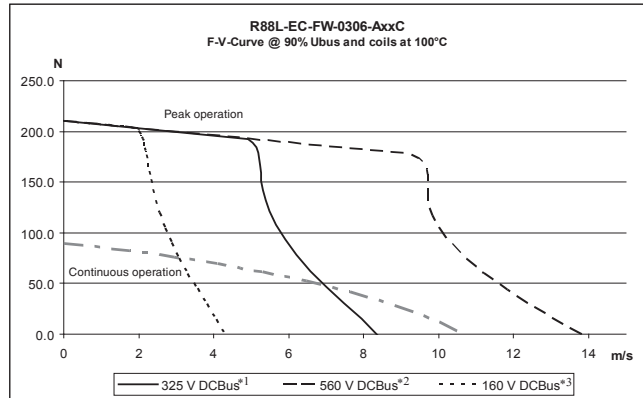
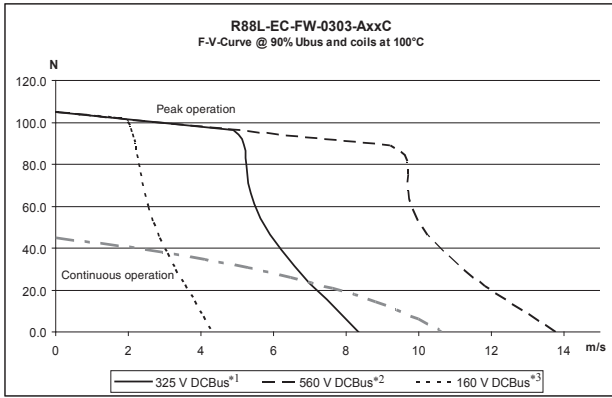

\*1 The DCBus voltage corresponds to an AC voltage input ( $V_{ACIN}$ ) of 235 V or more.

\*2 The DCBus voltage corresponds to an AC voltage input ( $V_{ACIN}$ ) of 400 V or more.

\*3 The DCBus voltage corresponds to an AC voltage input ( $V_{ACIN}$ ) of 115 V or more.

**Note:** The DCBus value is calculated from the below formula (where is the AV voltage drop in the DC Bus):

$$DCBus = V_{ACIN} \times \sqrt{2} - \Delta V$$

Ironless motors R88L-EC-GW-□ (230 VAC)

Voltage	230V									
Linear motor model	R88L-EC-GW-□	0303-□	0306-□	0309-□	0503-□	0506-□	0509-□	0703-□	0706-□	0709-□
Maximum speed (100V)	m/s	8			2.2			1.2		
Maximum speed (200V)	m/s	16			4.4			2.4		
Peak force <sup>1</sup>	N	100	200	300	240	480	720	700	1400	2100
Peak current <sup>1</sup>	Arms	5	10	15	3.5	7.0	10.5	5.6	11.3	16.9
Continuous force <sup>2</sup>	N	29	58	87	70	140	210	141	282	423
Continuous current <sup>2</sup>	Arms	1.5	2.9	4.4	1.03	2.1	3.1	1.14	2.27	3.4
Motor force constant	N/Arms	19.9			68			124		
BEMF	V/m/s	16			55.5			101		
Motor constant	N/√W	5.07	7.16	8.78	9.74	13.77	17.13	18.15	25.67	32.02
Phase resistance	Ω	5.5	2.8	1.8	15.9	8	5.3	15.8	7.9	5.3
Phase Inductance	mH	1.8	0.9	0.6	13	6.5	4.2	28	14	9
Electrical time constant	ms	0.35			0.8			1.8		
Max. cont. power dissipation (all coils)	W	47	95	142	67	134	200	82	165	247
Thermal resistance <sup>2</sup>	K/W	1.8	0.90	0.6	1.3	0.65	0.43	1.04	0.52	0.35
Thermal time constant	s	36			72			156		
Magnetic attraction force	N	0			0			0		
Magnet pole pitch	mm	30			42			57		
Weight coil unit <sup>3</sup>	kg	0.084	0.162	0.240	0.25	0.47	0.69	0.55	0.95	1.35
Weight magnet track	kg/m	4.8			11.2			24		
Protection methods <sup>4</sup>	Temperature sensors NTC10k, PTC110C, self cooling									
Hall sensor	Digital (optional)									
Insulation class	Class B									
Max. bus voltage	325 VDC									
Insulation resistance	500 VDC, min. 10 MΩ									
Di-electric strength	2250 V for 1 sec									
Max. allowable coil temperature	110°C									
Ambient humidity	20 to 80% non-condensing									
Max. allowable magnet temperature	70°C									

<sup>1</sup> Coil temperature rising 03-series by 40K/s, 05-series by 20K/s and 07-series by 20K/s.

<sup>2</sup> Values at 110°C coil temperature and magnets at 25°C. Coil unit installed on a water-cooled aluminium surface. Attention: All other values at 25°C. Values can have a tolerance of 10%.

<sup>3</sup> Weight without connector and cable.

<sup>4</sup> I<sub>pk</sub> has to be set properly for high current overload applications.

All other values at 25°C (±10%).

Force-speed characteristics

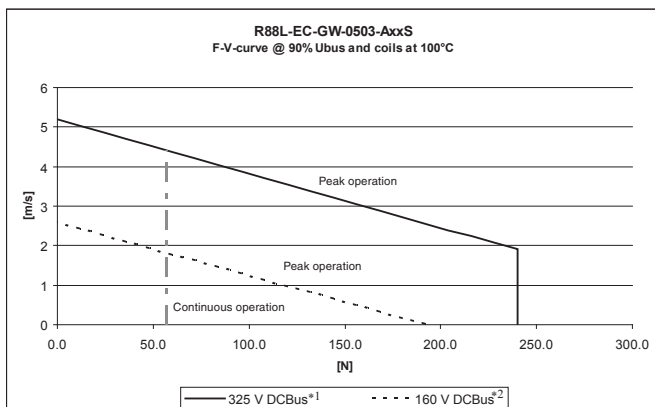
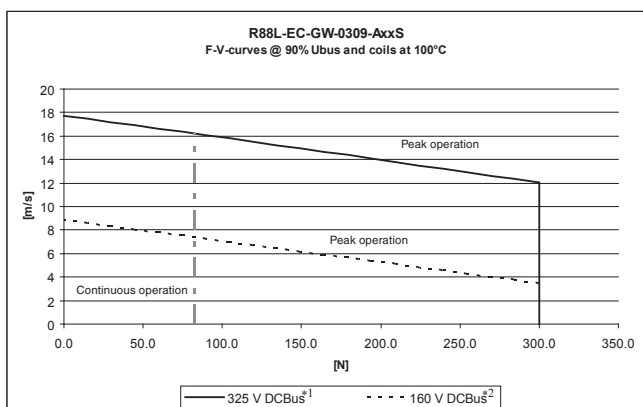
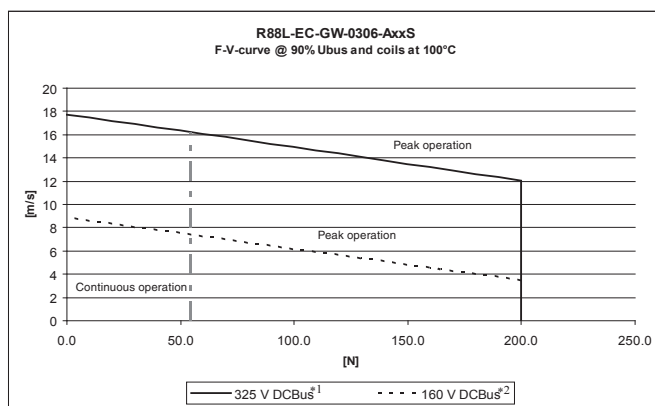
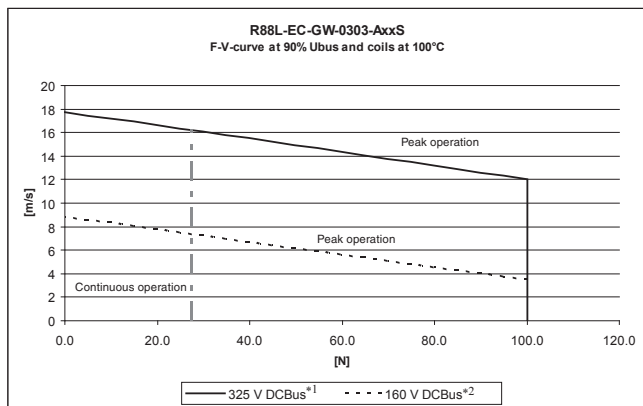

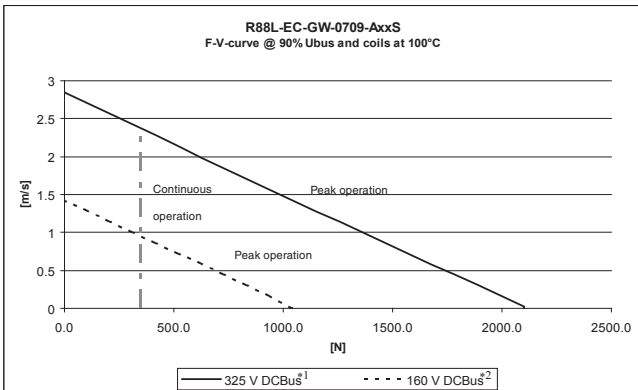
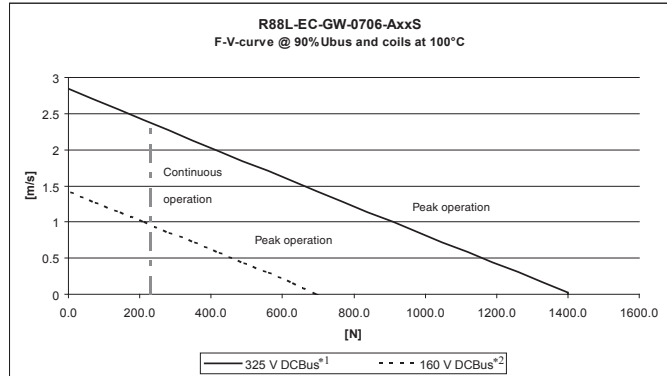
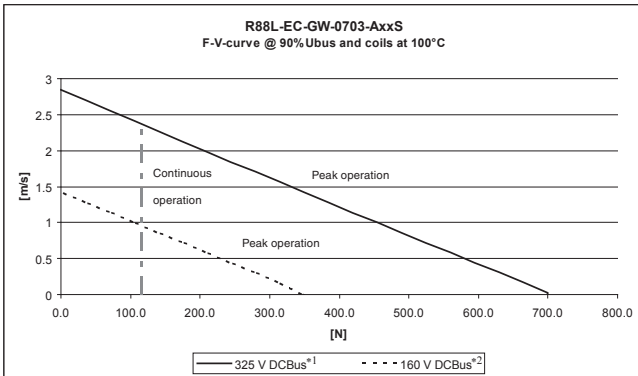
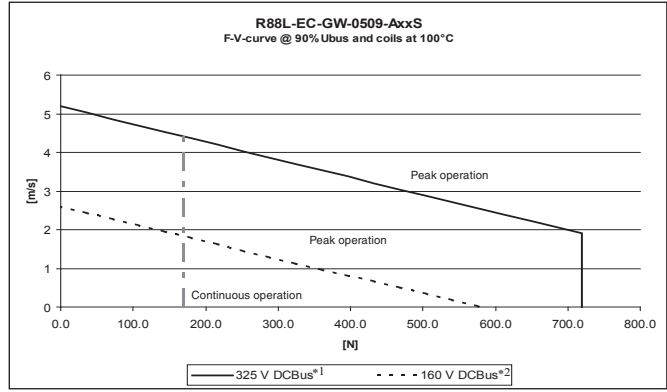
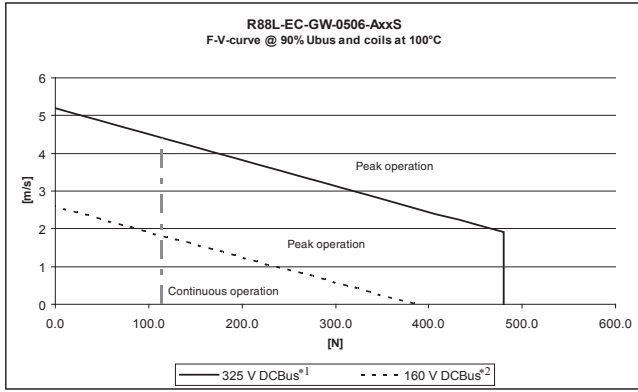

\*1 The DCBus voltage corresponds to an AC voltage input ( $V_{ACIN}$ ) of 235V or more.

\*2 The DCBus voltage corresponds to an AC voltage input ( $V_{ACIN}$ ) of 115V or more.

**Note:** The DCBus value is calculated from the below formula:

$$DCBus = V_{ACIN} \times \sqrt{2} - \Delta V$$

**Dimensions**

**Iron-core R88L-EC-FW-03**

**Motor coil**

Model	L1 (mm)	L2 (mm)	n
R88L-EC-FW-0303-□	105 ±0.5	79 +0.15/-0.35	1
R88L-EC-FW-0306-□	153 ±0.5	127 +0.15/-0.35	2

Motor coil dimensions with magnet track and hall sensor (optional)

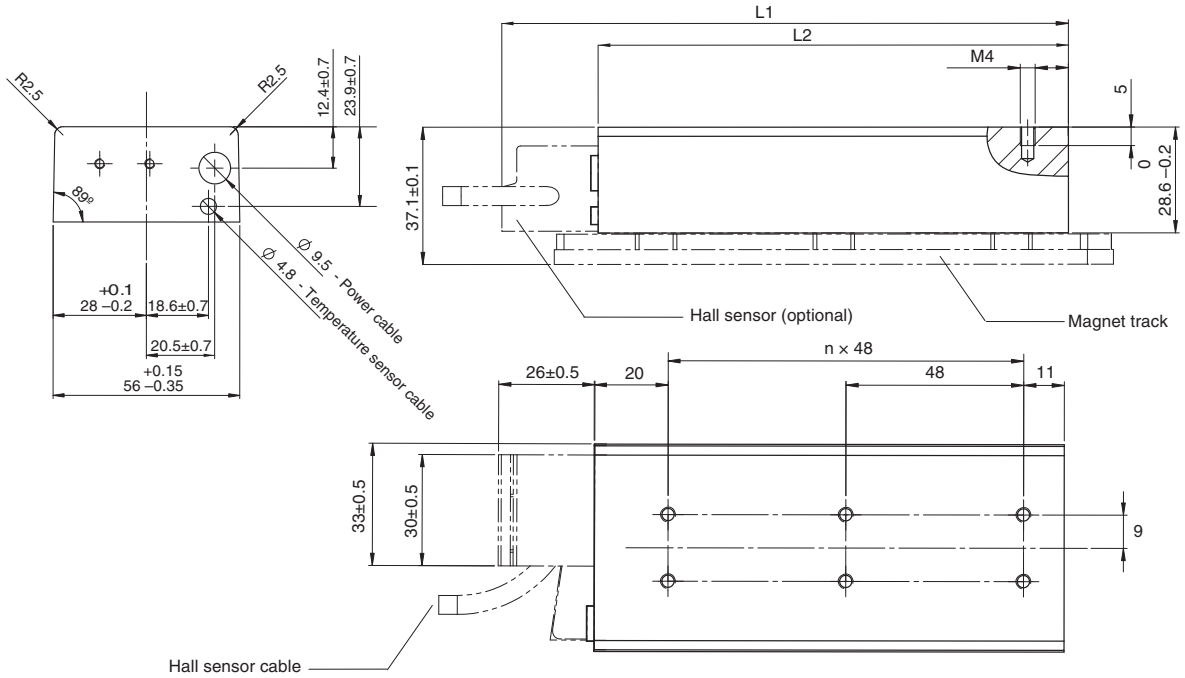

Wiring specifications for motor with connectors

Units: mm



Cable length 500±30  
 Connector optional  
 Made by Hypertac  
 LPPA06AMRPN182 (MALE)  
 Pin article code: 021.279.1020

Power connector		
Pin No.	Wire	Function
1	Black-1	Phase U
2	Black-2	Phase V
3	Green/Yellow	Ground
4	Black-3	Phase W
5	Not used	-
6	Not used	-

Mating connector:  
 Plug type: LPRA06BFRBN170

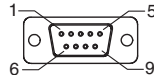

Cable length 500±30  
 Connector optional  
 D-Sub 9-pin (FEMALE)

Temperature sensor connector		
Pin No.	Wire	Function
1	Not used	-
2	Not used	-
3	Not used	-
4	Not used	-
5	Not used	-
6	White	PTC
7	Brown	PTC
8	Green	KTY
9	Yellow	KTY
Case	Shield	-

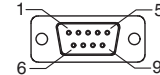

Cable length 500±30  
 D-Sub 9-pin (FEMALE)

Hall sensor connector (optional)		
Pin No.	Wire	Function
1	Brown	5V
2	Red	Hall U
3	Grey	Hall V
4	Yellow	Hall W
5	White	GND
6	Not used	Not used
7	Not used	Not used
8	Not used	Not used
9	Not used	Not used
Case	Shield	-

**Magnet track**

Model	L1 (mm)	n	Approx. weight (kg/m)
R88L-EC-FM-03096-A	96	1	2.1
R88L-EC-FM-03144-A	144	2	
R88L-EC-FM-03384-A	384	7	

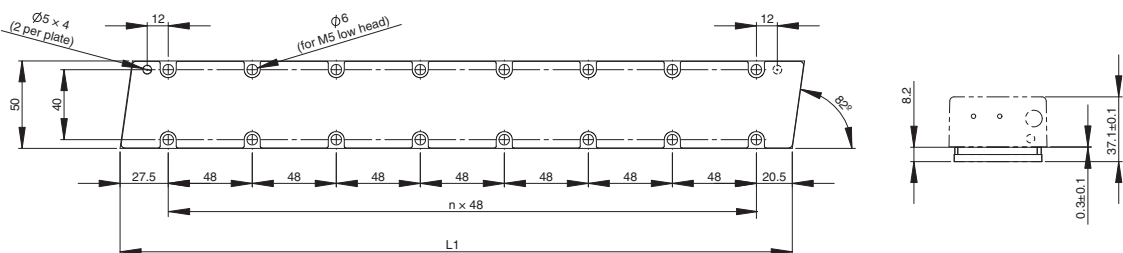

## Iron-core R88L-EC-FW-06□

### Motor coil

Model	L1 (mm)	L2 (mm)	n
R88L-EC-FW-0606-□	153 ±0.5	127 +0.15/-0.35	2
R88L-EC-FW-0609-□	201 ±0.5	175 +0.15/-0.35	3
R88L-EC-FW-0612-□	249 ±0.5	223 +0.15/-0.35	4

Motor coil dimensions with magnet track and hall sensor (optional)

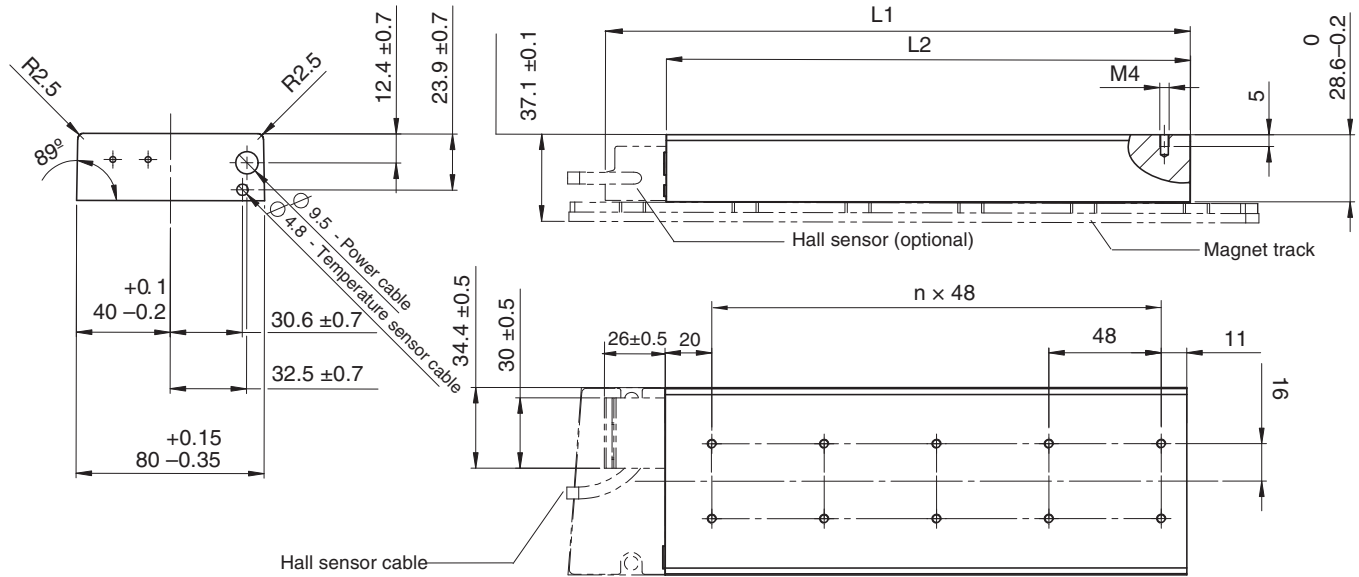

Units: mm

Wiring specifications for motor with connectors



Cable length 500±30  
Connector optional  
Made by Hypertac  
LRR06AMRPN182 (MALE)  
Pin article code: 021.279.1020

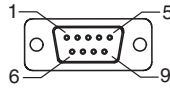

Cable length 500±30  
Connector optional  
D-Sub 9-pin (FEMALE)

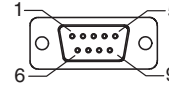

Cable length 500±30  
D-Sub 9-pin (FEMALE)

Power connector		
Pin No.	Wire	Function
1	Black-1	Phase U
2	Black-2	Phase V
3	Green/Yellow	Ground
4	Black-3	Phase W
5	Not used	-
6	Not used	-

Mating connector:  
Plug type: LPRA06BFRBN170

Temperature sensor connector		
Pin No.	Wire	Function
1	Not used	-
2	Not used	-
3	Not used	-
4	Not used	-
5	Not used	-
6	White	PTC
7	Brown	PTC
8	Green	KTY
9	Yellow	KTY
Case	Shield	-

Hall sensor connector (optional)		
Pin No.	Wire	Function
1	Brown	5 V
2	Red	Hall U
3	Grey	Hall V
4	Yellow	Hall W
5	White	GND
6	Not used	Not used
7	Not used	Not used
8	Not used	Not used
9	Not used	Not used
Case	Shield	-

### Magnet track

Model	L1 (mm)	n	Approx. weight (kg/m)
R88L-EC-FM-06192-A	192	3	3.8
R88L-EC-FM-06288-A	288	5	

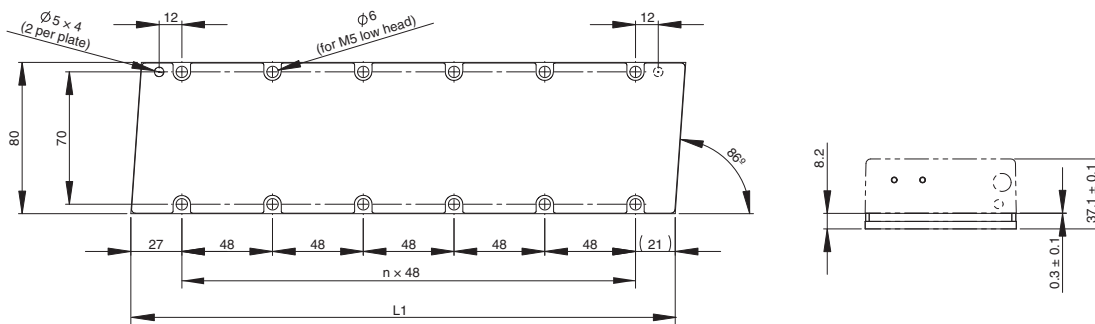



Iron-core R88L-EC-FW-11□

Motor coil

Model	L1 (mm)	L2 (mm)	n
R88L-EC-FW-1112-□	249 ±0.5	223 +0.15/-0.35	4
R88L-EC-FW-1115-□	297 ±0.5	271 +0.15/-0.35	5

Motor coil dimensions with magnet track and hall sensor (optional)

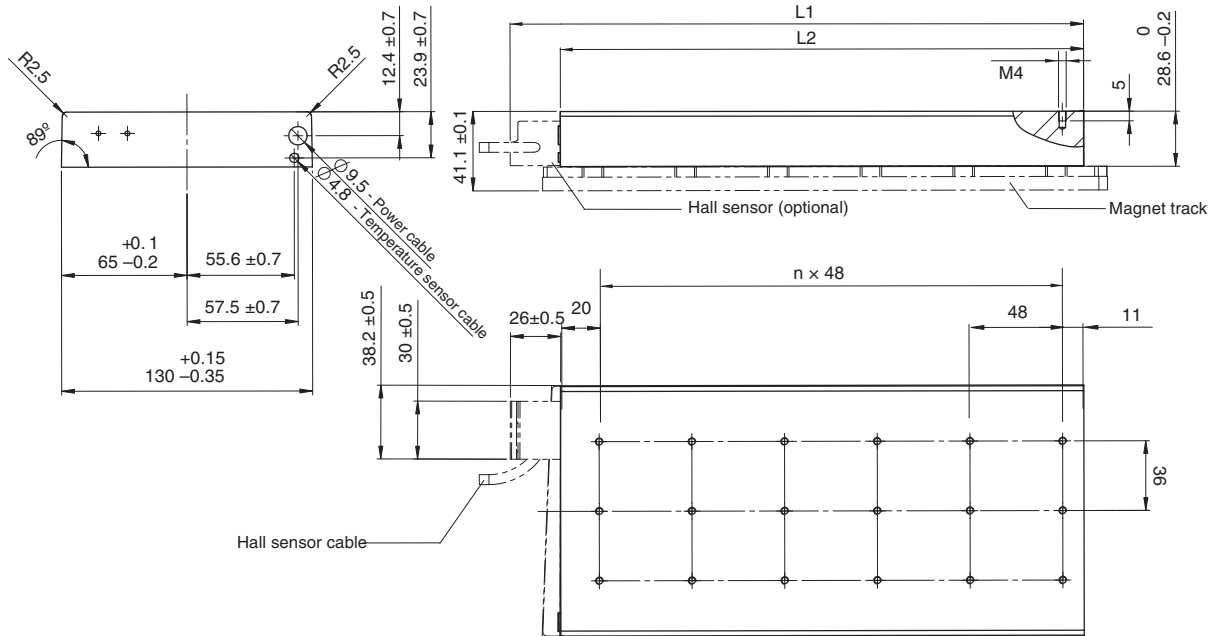

Units: mm

Wiring specifications for motor with connectors



Cable length 500±30  
Connector optional  
Made by Hypertac  
LRRA06AMRPN182 (MALE)  
Pin article code: 021.279.1020

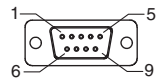

Cable length 500±30  
Connector optional  
D-Sub 9-pin (FEMALE)

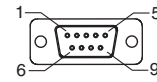

Cable length 500±30  
D-Sub 9-pin (FEMALE)

Power connector		
Pin No.	Wire	Function
1	Black-1	Phase U
2	Black-2	Phase V
3	Green/Yellow	Ground
4	Black-3	Phase W
5	Not used	-
6	Not used	-

Mating connector:  
Plug type: LPRA06BFRBN170

Temperature sensor connector		
Pin No.	Wire	Function
1	Not used	-
2	Not used	-
3	Not used	-
4	Not used	-
5	Not used	-
6	White	PTC
7	Brown	PTC
8	Green	KTY
9	Yellow	KTY
Case	Shield	-

Hall sensor connector (optional)		
Pin No.	Wire	Function
1	Brown	5 V
2	Red	Hall U
3	Grey	Hall V
4	Yellow	Hall W
5	White	GND
6	Not used	Not used
7	Not used	Not used
8	Not used	Not used
9	Not used	Not used
Case	Shield	-

Magnet track

Model	L1 (mm)	n	Approx. weight (kg/m)
R88L-EC-FM-11192-A	192	3	10.5
R88L-EC-FM-11288-A	288	5	

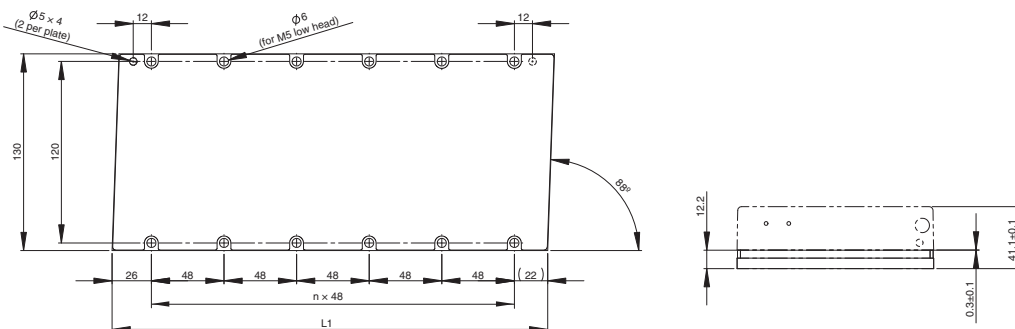

## Ironless R88L-EC-GW-03

### Motor coil

Model	L1 (mm)	L2 (mm)	n
R88L-EC-GW-0303-	95.4	78	3
R88L-EC-GW-0306-	155.4	138	6
R88L-EC-GW-0309-	215.4	198	9

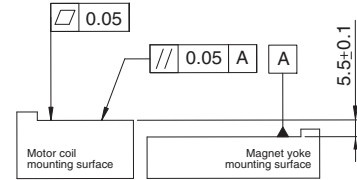
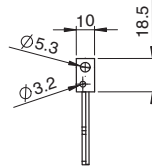
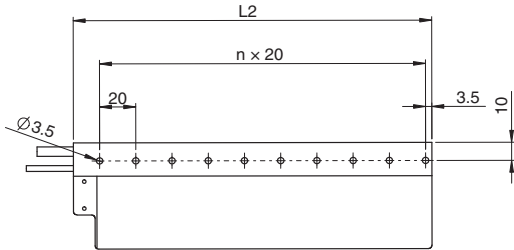

Motor with magnet track (separate order no.)

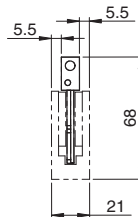
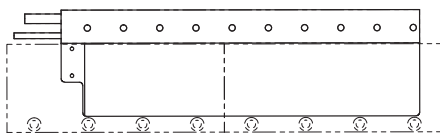

Motor with hall sensor (optional)

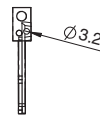
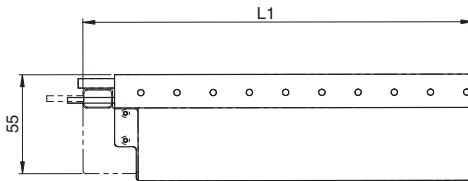

Wiring specifications for motor with connectors

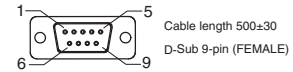
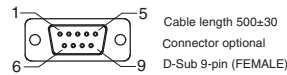
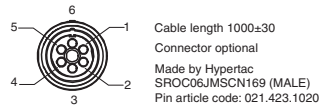

Power connector		
Pin No.	Wire	Function
1	Black	Phase U
2	Red	Phase V
3	White	Phase W
4	Not used	-
5	Not used	-
6	Green	Ground

Mating connector:  
Plug type: SPOC06KFSDN169

Temperature sensor connector		
Pin No.	Wire	Function
1	Not used	-
2	Not used	-
3	Not used	-
4	Not used	-
5	Not used	-
6	White	PTC
7	Brown	PTC
8	Green	NTC
9	Yellow	NTC
Case	Shield	-

Hall sensor connector (optional)		
Pin No.	Wire	Function
1	Brown	5 V
2	Red	Hall U
3	Grey	Hall V
4	Yellow	Hall W
5	White	GND
6	Not used	Not used
7	Not used	Not used
8	Not used	Not used
9	Not used	Not used
Case	Shield	-

Units: mm

### Magnet track

Model	L1 (mm)	n	Approx. weight (kg/m)
R88L-EC-GM-03090-A	90	2	4.8
R88L-EC-GM-03120-A	120	3	
R88L-EC-GM-03390-A	390	12	

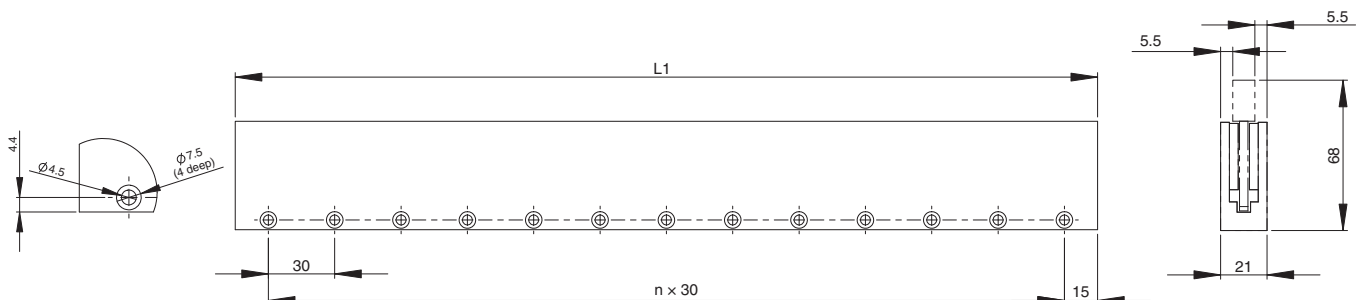

Ironless R88L-EC-GW-05□

Motor coil

Model	L1 (mm)	L2 (mm)	n
R88L-EC-GW-0503-□	123.4	106	3
R88L-EC-GW-0506-□	207.4	190	6
R88L-EC-GW-0509-□	291.4	274	9

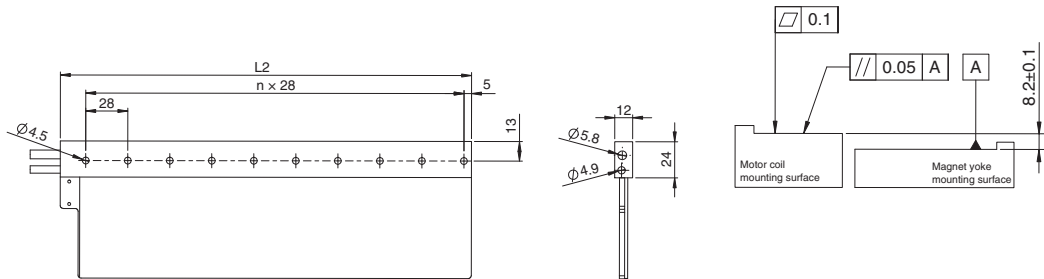

Motor with magnet track (separate order no.)

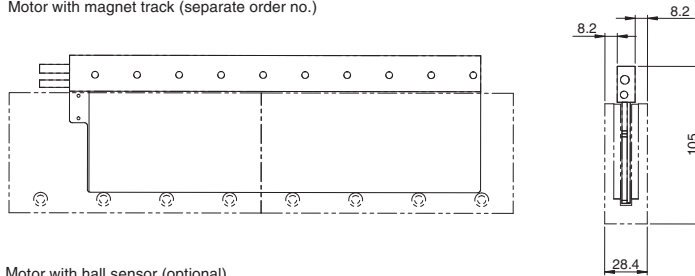

Motor with hall sensor (optional)

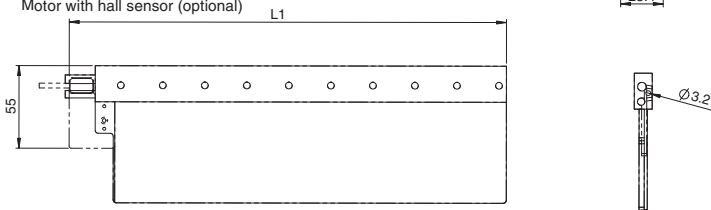

Units: mm

Wiring specifications for motor with connectors

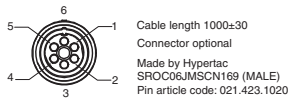

Pin No.	Wire	Function
1	Black	Phase U
2	Red	Phase V
3	White	Phase W
4	Not used	-
5	Not used	-
6	Green	Ground

Mating connector:  
Plug type: SPOC06KFSND169

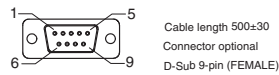

Pin No.	Wire	Function
1	Not used	-
2	Not used	-
3	Not used	-
4	Not used	-
5	Not used	-
6	White	PTC
7	Brown	PTC
8	Green	NTC
9	Yellow	NTC
Case	Shield	-

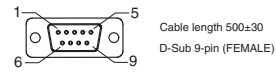

Pin No.	Wire	Function
1	Brown	5 V
2	Red	Hall U
3	Grey	Hall V
4	Yellow	Hall W
5	White	GND
6	Not used	Not used
7	Not used	Not used
8	Not used	Not used
9	Not used	Not used
Case	Shield	-

Magnet track

Model	L1 (mm)	n	Approx. weight (kg/m)
R88L-EC-GM-05126-A	126	2	11.2
R88L-EC-GM-05168-A	168	3	
R88L-EC-GM-05210-A	210	4	
R88L-EC-GM-05546-A	546	12	

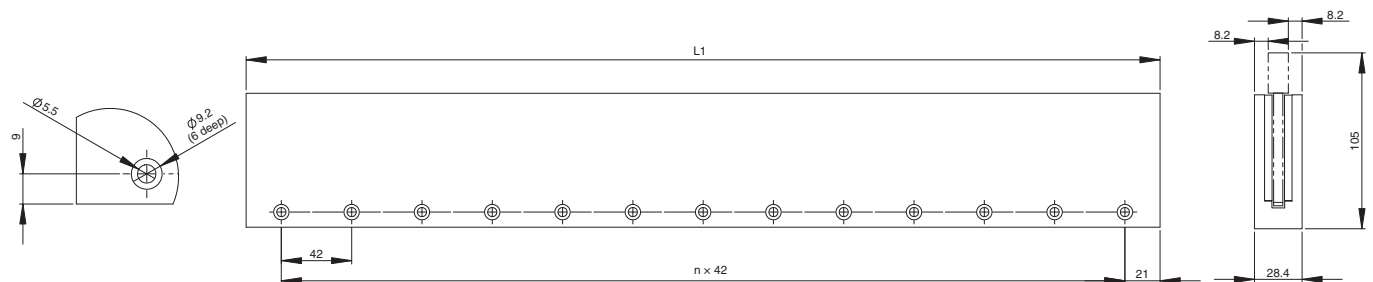

## Ironless R88L-EC-GW-07□

### Motor coil

Model	L1 (mm)	L2 (mm)	n
R88L-EC-GW-0703-□	151.4	134	3
R88L-EC-GW-0706-□	265.4	248	6
R88L-EC-GW-0709-□	379.4	362	9

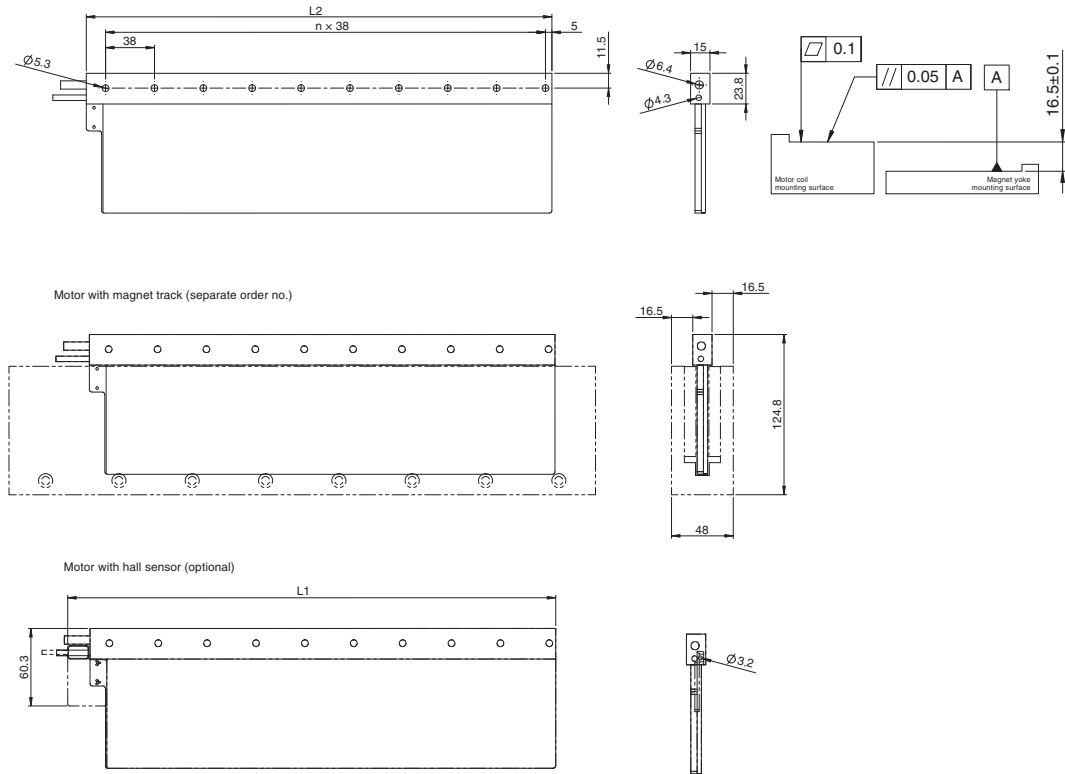

#### Wiring specifications for motor with connectors

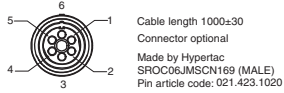

Power connector		
Pin No.	Wire	Function
1	Black	Phase U
2	Red	Phase V
3	White	Phase W
4	Not used	—
5	Not used	—
6	Green	Ground

Mating connector:  
Plug type: SPOC06KFSN169

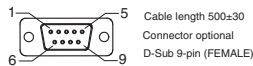

Temperature sensor connector		
Pin No.	Wire	Function
1	Not used	—
2	Not used	—
3	Not used	—
4	Not used	—
5	Not used	—
6	White	PTC
7	Brown	PTC
8	Green	NTC
9	Yellow	NTC
Case	Shield	—

Units: mm

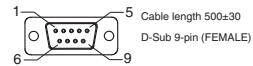

Hall sensor connector (optional)		
Pin No.	Wire	Function
1	Brown	5V
2	Red	Hall U
3	Grey	Hall V
4	Yellow	Hall W
5	White	GND
6	Not used	Not used
7	Not used	Not used
8	Not used	Not used
9	Not used	Not used
Case	Shield	—

### Magnet track

Model	L1 (mm)	n	Approx. weight (kg/m)
R88L-EC-GM-07114-A	114	1	25.5
R88L-EC-GM-07171-A	171	2	
R88L-EC-GM-07456-A	456	7	

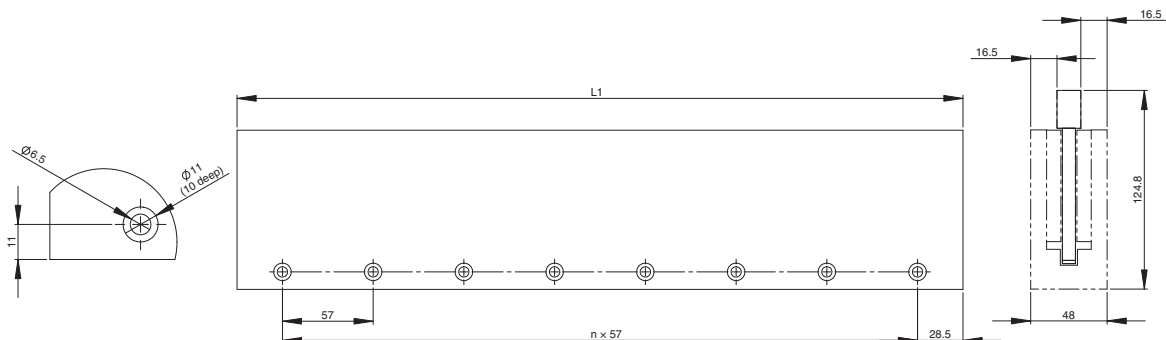

Optional serial converter unit

Specifications

Serial converter model R88A-		SC01K-E	SC02K-E
<b>Description</b>		Serial converter from 1 Vpp to G5 serial data transmission and with hall sensor input	
<b>Temperature sensor</b>		KTY sensor detection of iron-core motor coil	NTC sensor detection of ironless motor coil
<b>Electrical characteristics</b>	<b>Power supply voltage</b>	5 VDC, max. 250 mA supplied by the drive	
	<b>Standard resolution</b>	Interpolation factor 100 plus quadrature count	
	<b>Max. input frequency</b>	400 kHz 1 Vpp	
	<b>Analog input signals (cos, sin, Ref)</b>	Differential input amplitude: 0.4 V to 1.2 V Input signal level: 1.5 V to 3.5 V	
	<b>Output signals</b>	Position data, hall & temperature sensor information, and alarms	
	<b>Output method</b>	Serial data transmission	
<b>Mechanical characteristics</b>	<b>Transmission cycle</b>	<42 μs	
	<b>Vibration resistance</b>	98 m/s <sup>2</sup> max. (1 to 2500 Hz) in three directions	
	<b>Shock resistance</b>	980 m/s <sup>2</sup> , (11 ms) two times in three directions	
<b>Environmental conditions</b>	<b>Operating temperature</b>	0 to 55°C	
	<b>Storage temperature</b>	-20 to +80°C	
	<b>Humidity</b>	20% to 90% relative humidity (without condensation)	

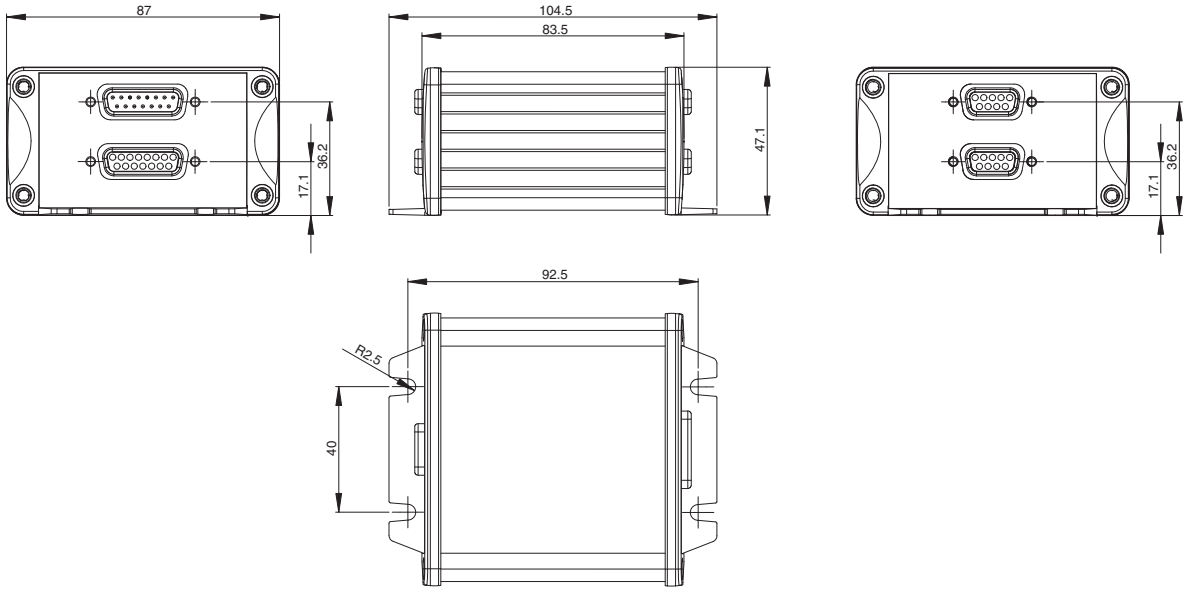

**CN4**  
Serial data output to linear servo drive

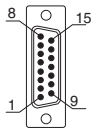

Connector D-Sub 15-pin (male)

Pin No.	Signal
1	PS
2	/PS
3	Not used
4	Not used
5	Not used
6	Not used
7	Not used
8	5 V
9	0 V
10	Not used
11	Not used
12	Not used
13	Not used
14	Not used
15	Inner shield
Case	Shield

**CN3**  
Temperature sensor interface without Hall sensor



Connector D-Sub 9-pin (female)

Pin No.	Signal
1	Not used
2	Not used
3	Not used
4	Not used
5	Not used
6	PTC
7	PTC
8	KTY/NTC
9	KTY/NTC
Case	Shield

**CN1**  
Encoder input 1Vpp with programmable lines NUMERIK JENA standard

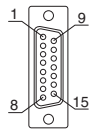

Connector D-Sub 15-pin (female)

Pin No.	Signal
1	SDA*
2	SCL*
3	Not used
4	/Ref signal (U <sub>0-</sub> )
5	/Cos signal (U <sub>2-</sub> )
6	/Sin signal (U <sub>1-</sub> )
7	Not used
8	5 V
9	0 V
10	Not used
11	Not used
12	Ref signal (U <sub>0</sub> )
13	Cos signal (U <sub>2</sub> )
14	Sin signal (U <sub>1</sub> )
15	Inner shield (IS)
Case	Shield

**CN2**  
Hall & temperature sensors interface

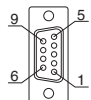

Connector D-Sub 9-pin (female)

Pin No.	Signal
1	5V
2	Hall U
3	Hall V
4	Hall W
5	GND
6	PTC
7	PTC
8	KTY/NTC
9	KTY/NTC
Case	Shield

\*Reserved. Please do not use

**Note:** As the 6,7,8,9 pins in the CN2 and CN3 connectors are internally wired, the Temperature sensor can be connected to both connectors. When the Hall sensor is also required, use the same cable for Hall & Temperature signals and the CN2 connector.

## Ordering information

(Refer to servo drive chapter)

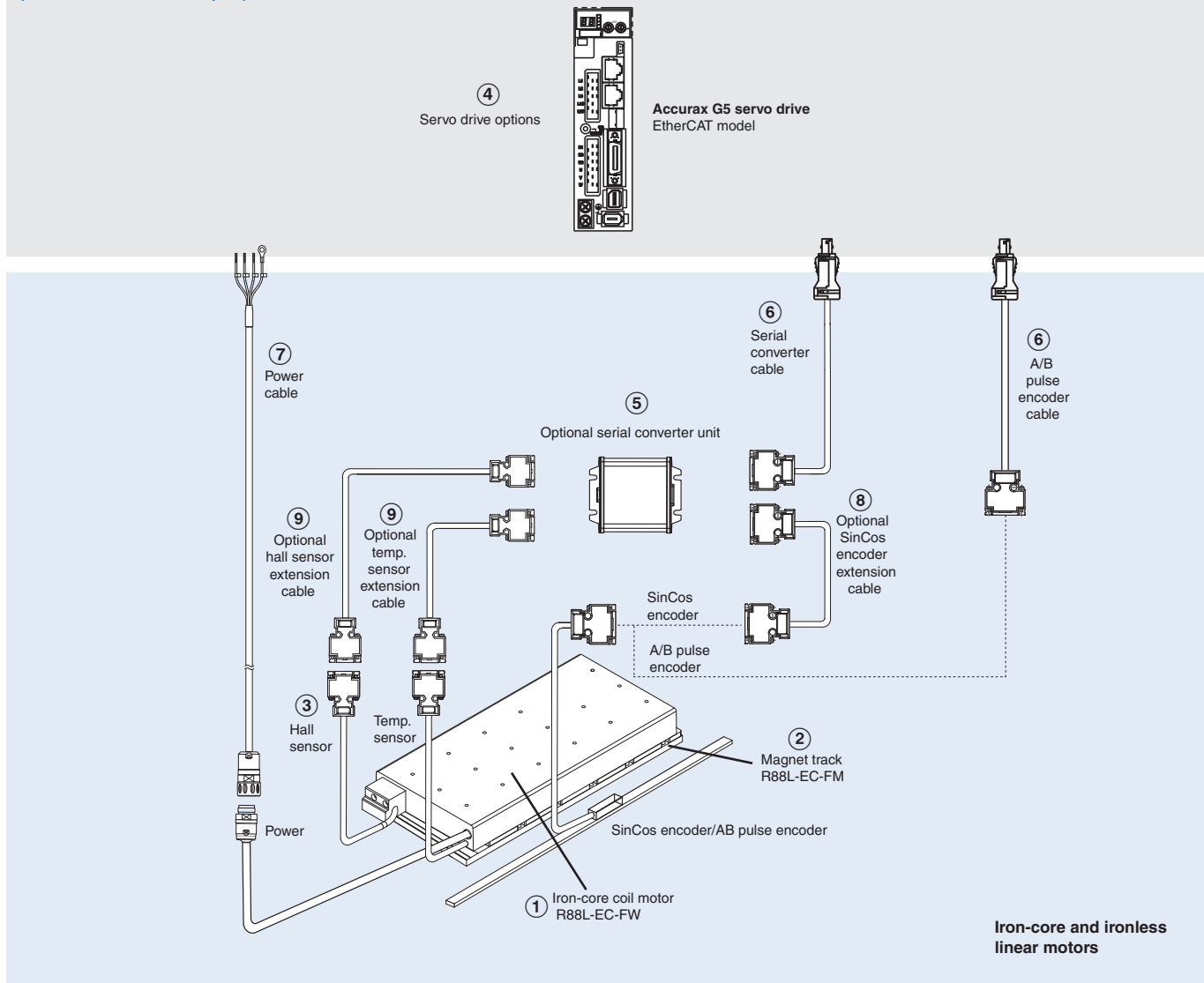

**Note:** The symbols ①②③... show the recommended sequence to select the linear motor, cables and serial converter for a linear motor system.

### Linear motors

#### R88L-EC-FW-□ Iron-core type

230 VAC single phase/three phase, 400 VAC three phase

Linear motor parts						Linear Servo drive			
Symbol	Rated force	Peak force	① Iron-core motor coil	② Magnet track	③ Hall Sensor	④ Accurax G5 EtherCAT			
						230 V	400 V		
	48 N	105 N	Coil without connectors	R88L-EC-FW-0303-ANPC	R88L-EC-FM-03096-A	R88L-EC-FH-NNNN-A	R88D-KN02H-ECT-L	R88D-KN06F-ECT-L	
	96 N	210 N		R88L-EC-FW-0306-ANPC	R88L-EC-FM-03144-A R88L-EC-FM-03384-A		R88D-KN04H-ECT-L	R88D-KN10F-ECT-L	
	160 N	400 N		R88L-EC-FW-0606-ANPC	R88L-EC-FM-06192-A R88L-EC-FM-06288-A		R88D-KN08H-ECT-L	R88D-KN15F-ECT-L	
	240 N	600 N		R88L-EC-FW-0609-ANPC			R88D-KN10H-ECT-L	R88D-KN20F-ECT-L	
	320 N	800 N		R88L-EC-FW-0612-ANPC			R88D-KN15H-ECT-L	R88D-KN30F-ECT-L	
	608 N	1600 N		R88L-EC-FW-1112-ANPC			R88D-KN15H-ECT-L	R88D-KN30F-ECT-L	
	760 N	2000 N		R88L-EC-FW-1115-ANPC			R88L-EC-FM-11288-A	R88D-KN15H-ECT-L	R88D-KN30F-ECT-L
	48 N	105 N		Coil with connectors			R88L-EC-FW-0303-APLC	R88L-EC-FM-03096-A	R88D-KN02H-ECT-L
	96 N	210 N	R88L-EC-FW-0306-APLC		R88L-EC-FM-03144-A R88L-EC-FM-03384-A		R88D-KN04H-ECT-L	R88D-KN10F-ECT-L	
	160 N	400 N	R88L-EC-FW-0606-APLC		R88L-EC-FM-06192-A R88L-EC-FM-06288-A		R88D-KN08H-ECT-L	R88D-KN15F-ECT-L	
	240 N	600 N	R88L-EC-FW-0609-APLC				R88D-KN10H-ECT-L	R88D-KN20F-ECT-L	
	320 N	800 N	R88L-EC-FW-0612-APLC				R88D-KN15H-ECT-L	R88D-KN30F-ECT-L	
	608 N	1600 N	R88L-EC-FW-1112-APLC				R88D-KN15H-ECT-L	R88D-KN30F-ECT-L	
	760 N	2000 N	R88L-EC-FW-1115-APLC				R88L-EC-FM-11288-A	R88D-KN15H-ECT-L	R88D-KN30F-ECT-L

R88L-EC-GW-□ Ironless type

230 VAC single phase/three phase

Linear motor parts						Linear Servo drive	
Type	Rated force	Peak force	① Ironless motor coil	② Magnet track	③ Hall Sensor	④ Accurax G5 EtherCAT 230V	
	29 N	100 N	Coil without connectors	R88L-EC-GW-0303-ANPS	R88L-EC-GM-03090-A	R88L-EC-GH-03NN-A	R88D-KN02H-ECT-L
	58 N	200 N		R88L-EC-GW-0306-ANPS	R88L-EC-GM-03120-A		R88D-KN08H-ECT-L
	87 N	300 N		R88L-EC-GW-0309-ANPS	R88L-EC-GM-03390-A		R88D-KN10H-ECT-L
	70 N	240 N		R88L-EC-GW-0503-ANPS	R88L-EC-GM-05126-A	R88L-EC-GH-05NN-A	R88D-KN02H-ECT-L
	140 N	480 N		R88L-EC-GW-0506-ANPS	R88L-EC-GM-05546-A		R88D-KN04H-ECT-L
	210 N	720 N		R88L-EC-GW-0509-ANPS	R88L-EC-GM-05168-A R88L-EC-GM-05210-A		R88D-KN08H-ECT-L
	141 N	700 N		R88L-EC-GW-0703-ANPS	R88L-EC-GM-07114-A	R88L-EC-GH-07NN-A	R88D-KN04H-ECT-L
	282 N	1400 N		R88L-EC-GW-0706-ANPS	R88L-EC-GM-07171-A		R88D-KN08H-ECT-L
	423 N	2100 N		R88L-EC-GW-0709-ANPS	R88L-EC-GM-07456-A		R88D-KN10H-ECT-L
	29 N	100 N	Coil with connectors	R88L-EC-GW-0303-APLS	R88L-EC-GM-03090-A	R88L-EC-GH-03NN-A	R88D-KN02H-ECT-L
	58 N	200 N		R88L-EC-GW-0306-APLS	R88L-EC-GM-03120-A		R88D-KN08H-ECT-L
	87 N	300 N		R88L-EC-GW-0309-APLS	R88L-EC-GM-03390-A		R88D-KN10H-ECT-L
	70 N	240 N		R88L-EC-GW-0503-APLS	R88L-EC-GM-05126-A	R88L-EC-GH-05NN-A	R88D-KN02H-ECT-L
	140 N	480 N		R88L-EC-GW-0506-APLS	R88L-EC-GM-05546-A R88L-EC-GM-05168-A R88L-EC-GM-05210-A		R88D-KN04H-ECT-L
	210 N	720 N		R88L-EC-GW-0509-APLS	R88L-EC-GM-07114-A		R88D-KN08H-ECT-L
	141 N	700 N		R88L-EC-GW-0703-APLS	R88L-EC-GM-07114-A	R88L-EC-GH-07NN-A	R88D-KN04H-ECT-L
	282 N	1400 N		R88L-EC-GW-0706-APLS	R88L-EC-GM-07171-A		R88D-KN08H-ECT-L
	423 N	2100 N		R88L-EC-GW-0709-APLS	R88L-EC-GM-07456-A		R88D-KN10H-ECT-L

Servo drive

④ Refer to Accurax G5 servo drive chapter for detailed drive specifications and selection of drive accessories.

Serial converter unit

Symbol	Specifications	Model
⑤	Serial converter unit from 1 Vpp to G5 serial data transmission (with KTY sensor detection of iron-core motor coil)	R88A-SC01K-E
	Serial converter unit from 1 Vpp to G5 serial data transmission (with NTC sensor detection of ironless motor coil)	R88A-SC02K-E

Note: If no temperature sensor is needed, then it does not matter which converter you use.

Serial converter cable to servo drive

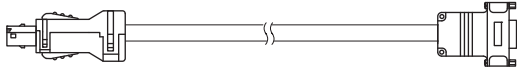
Symbol	Specifications	Model	Appearance	
⑥	Accurax G5-Linear drive to serial converter cable. (Connectors R88A-CNK41L and DB-15)	1.5 m	R88A-CRKN001-5CR-E	
		3 m	R88A-CRKN003CR-E	
		5 m	R88A-CRKN005CR-E	
		10 m	R88A-CRKN010CR-E	
		15 m	R88A-CRKN015CR-E	
		20 m	R88A-CRKN020CR-E	

Note: This cable can be used also for A/B pulse encoder Numerik Jena standard pinout.

Power cable

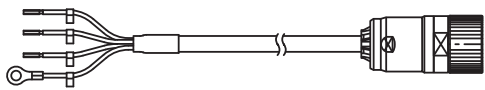
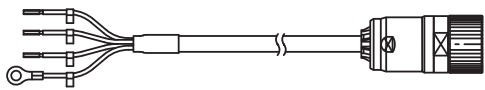
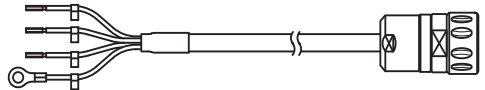
Symbol	Specifications	Model	Appearance	
⑦	For iron-core linear motors R88L-EC-FW-0303-□ R88L-EC-FW-0306-□	1.5 m	R88A-CAWK001-5S-DE	
		3 m	R88A-CAWK003S-DE	
		5 m	R88A-CAWK005S-DE	
		10 m	R88A-CAWK010S-DE	
		15 m	R88A-CAWK015S-DE	
		20 m	R88A-CAWK020S-DE	
	For iron-core linear motors R88L-EC-FW-0606-□ R88L-EC-FW-0609-□ R88L-EC-FW-0612-□ R88L-EC-FW-1112-□ R88L-EC-FW-1115-□	1.5 m	R88A-CAWL001-5S-DE	
		3 m	R88A-CAWL003S-DE	
		5 m	R88A-CAWL005S-DE	
		10 m	R88A-CAWL010S-DE	
		15 m	R88A-CAWL015S-DE	
		20 m	R88A-CAWL020S-DE	
	For ironless linear motors R88L-EC-GW-□	1.5 m	R88A-CAWB001-5S-DE	
		3 m	R88A-CAWB003S-DE	
		5 m	R88A-CAWB005S-DE	
		10 m	R88A-CAWB010S-DE	
		15 m	R88A-CAWB015S-DE	
		20 m	R88A-CAWB020S-DE	

## Linear encoder cable to serial converter

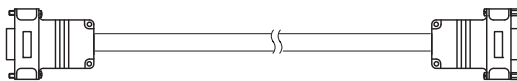
Symbol	Specifications	Model	Appearance	
⑧	Extension cable for <b>Numerik Jena</b> linear encoder to R88A-SC0□K-E serial converter (Connector DB-15) (This extension cable is optional)	1.5 m	R88A-CFKA001-5CR-E	
		3 m	R88A-CFKA003CR-E	
		5 m	R88A-CFKA005CR-E	
		10 m	R88A-CFKA010CR-E	
		15 m	R88A-CFKA015CR-E	
	Extension cable for <b>Renishaw</b> linear encoder to R88A-SC0□K-E serial converter (Connector DB-15) (This extension cable is optional)	1.5 m	R88A-CFKC001-5CR-E	
		3 m	R88A-CFKC003CR-E	
		5 m	R88A-CFKC005CR-E	
		10 m	R88A-CFKC010CR-E	
		15 m	R88A-CFKC015CR-E	
	Extension cable for <b>Heidenhain</b> linear encoder to R88A-SC0□K-E serial converter (Connector DB-15) (This extension cable is optional)	1.5 m	R88A-CFKD001-5CR-E	
		3 m	R88A-CFKD003CR-E	
		5 m	R88A-CFKD005CR-E	
		10 m	R88A-CFKD010CR-E	
		15 m	R88A-CFKD015CR-E	

## Hall and temperature sensors cable to serial converter

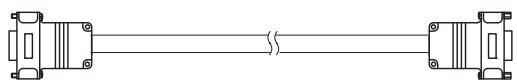
Symbol	Specifications	Model	Appearance	
⑨	Extension cable from hall and temperature sensors to R88A-SC0□K-E serial converter. (Connector DB-9) (This extension cable is optional)	1.5 m	R88A-CFKB001-5CR-E	
		3 m	R88A-CFKB003CR-E	
		5 m	R88A-CFKB005CR-E	
		10 m	R88A-CFKB010CR-E	
		15 m	R88A-CFKB015CR-E	

## Connectors

Specification	Model
Accurax G5 servo drive encoder connector (for CN4)	R88A-CNK41L
Hypertac power cable connector IP67 for iron-core linear motors	LPRA-06B-FRBN170
Hypertac power cable connector IP67 for ironless linear motors	SROC06JM5CN169

ALL DIMENSIONS SHOWN ARE IN MILLIMETERS.

To convert millimeters into inches, multiply by 0.03937. To convert grams into ounces, multiply by 0.03527.