

CJ Series IO-Link Connection Guide (EtherNet/IP™ Host Communications)

OMRON Corporation

Proximity Sensor (E2E-series IO-Link)

[IO-Link Master Unit]

OMRON Corporation

NX-series IO-Link Master Unit

(NX-ILM[][][])

NX-series Ethernet/IP Coupler Unit

(NX-EIC202)

About Intellectual Property Rights and Trademarks

Microsoft product screen shots reprinted with permission from Microsoft Corporation.

Windows is a registered trademark of Microsoft Corporation in the USA and other countries.

ODVA and EtherNet/IP™ are trademarks of ODVA.

Sysmac is a trademark or registered trademark of OMRON Corporation in Japan and other countries for OMRON factory automation products.

Company names and product names in this document are the trademarks or registered trademarks of their respective companies.

Table of Contents

1. Related Manuals	1
2. Terms and Definitions	2
3. Precautions	4
4. Overview	5
5. Applicable Devices and Device Configuration	6
5.1. Applicable Devices	6
5.2. Device Configuration	7
6. Communications Settings	9
6.1. EtherNet/IP Connection Parameters.....	9
6.2. IO-Link Connection Parameter	9
6.3. Slave Terminal Configuration	9
6.4. Tag Data Link Settings	10
7. IO-Link Connection Procedure	2
7.1. Work Flow	2
7.2. Slave Terminal Setup	4
7.3. PLC Setup	18
7.4. Network Settings for Host Communications	27
7.5. IO-Link Communication Status Check	39
8. Initialization Method	49
8.1. Initializing PLC.....	49
8.2. Initializing Slave Terminal.....	51
8.3. Initialization of Proximity Sensor	52
9. Revision History	53

1. Related Manuals

To ensure system safety, make sure to always read and follow the information provided in all Safety Precautions and Precautions for Safe Use in the manuals for each device which is used in the system.

The table below lists the manuals which pertain to this document.

Cat. No.	Model	Manual name
W472	CJ2M-CPU□□ CJ2H-CPU6□ CJ2H-CPU6□-EIP	CJ-series CJ2 CPU Unit Hardware USER'S MANUAL
W473	CJ2M-CPU□□ CJ2H-CPU6□ CJ2H-CPU6□-EIP	CJ-series CJ2 CPU Unit Software USER'S MANUAL
W465	CJ1W-EIP21 CJ2M-CPU3□ CJ2H-CPU6□-EIP	CJ Series EtherNet/IP™ Units OPERATION MANUAL
W446	CXONE-AL□□C-V4 / AL□□D-V4	CX-Programmer OPERATION MANUAL
0969584-7	W4S1-05□ W4S1-03B	Switching Hub W4S1-series Users Manual
W504	SYSMAC-SE2□□□	Sysmac Studio Version 1 Operation Manual
W536	NX-EIC202	NX-series EtherNet/IP™ Coupler Unit User's Manual
W567	NX-ILM□□□	NX-series IO-Link Master Unit User's Manual
W570	NX-ILM□□□ GX-ILM□□□	IO-Link System User's Manual
9540393-4	E2E(Q)-□-IL□	PROXIMITY SENSOR INSTRUCTION SHEET
9540292-0	E2E(Q)-□-IL□	PROXIMITY SENSOR INDEX LIST

2. Terms and Definitions

Term	Explanation and Definition
IO-Link device	A device with a sensor or an actuator that can perform IO-Link communications with an IO-Link master.
IO-Link master	A device that performs IO-Link communications with IO-Link devices in an IO-Link System and that simultaneously functions as a slave for host communications. "IO-Link Master Unit" is used to refer to a specific Unit in this document.
IO-Link Mode	A communication mode of an IO-Link master to perform IO-Link communications with IO-Link devices.
Cyclic communications	Communications that exchange data in a fixed period with no need for programming.
I/O data	All target data in cyclic communications with a host. IO-Link Systems contain the following two types of I/O data. <ul style="list-style-type: none"> • Target data in cyclic communications with a host in an IO-Link master • Target data in IO-Link devices for cyclic communications with an IO-Link master
Process data	I/O data in IO-Link devices. You can allocate a maximum of 32 bytes of process data in a master.
IODD file	A definition file for an IO-Link device. The parameter settings for an IO-Link device can be made by installing this file in CX-ConfiguratorFDT.
Node	A programmable controller and a device are connected to an EtherNet/IP network via EtherNet/IP ports. EtherNet/IP recognizes each EtherNet/IP port connected to the network as one node. When a device with two EtherNet/IP ports is connected to the EtherNet/IP network, EtherNet/IP recognizes this device as two nodes. EtherNet/IP achieves the communications between programmable controllers or the communications between a programmable controller and a device by exchanging data between these nodes connected to the network.
Tag	A minimum unit of the data that is exchanged on the EtherNet/IP network is called a tag. The tag is defined as a network variable or as a physical address, and it is assigned to the memory area of each device.
Tag set	In the EtherNet/IP network, a data unit that consists of two or more tags can be exchanged. The data unit consisting of two or more tags for the data exchange is called a tag set. Up to eight tags can be configured per tag set for the programmable controllers produced by OMRON Corporation.

Tag data link	In EtherNet/IP, the tag and tag set can be exchanged cyclically between nodes without using a user program. This feature is called a tag data link.
Connection	A connection is used to exchange data as a unit within which data concurrency is maintained. The connection consists of tags or tag sets. Creating the concurrent tag data link between the specified nodes is called a "connection establishment". When the connection is established, the tags or tag sets that configure the connection are exchanged between the specified nodes concurrently.
Connection type	There are two kinds of connection types for the tag data link connection. One is a multi-cast connection, and the other is a unicast (point-to-point) connection. The multi-cast connection sends an output tag set in one packet to more than one node. The unicast connection separately sends one output tag set to each node. Therefore, multi-cast connections can decrease the communications load if one output tag set is sent to more than one node.
Originator and Target	To operate tag data links, one node requests the opening of a communications line called a "connection". The node that requests to open the connection is called an "originator", and the node that receives the request is called a "target".
Tag data link parameter	A tag data link parameter is the setting data to operate tag data links. It includes the data to set tags, tag sets, and connections.

3. Precautions

- (1) Understand the specifications of devices which are used in the system. Allow some margin for ratings and performance. Provide safety measures, such as installing a safety circuit, in order to ensure safety and minimize the risk of abnormal occurrence.
- (2) To ensure system safety, make sure to always read and follow the information provided in all Safety Precautions and Precautions for Safe Use in the manuals for each device which is used in the system.
- (3) The user is encouraged to confirm the standards and regulations that the system must conform to.
- (4) It is prohibited to copy, to reproduce, and to distribute a part or the whole of this document without the permission of OMRON Corporation.
- (5) The information contained in this document is current as of August 2016. It is subject to change for improvement without notice.

The following notations are used in this document.



Indicates a potentially hazardous situation which, if not avoided, may result in minor or moderate injury or property damage.



Precautions for Correct Use

Precautions on what to do and what not to do to ensure proper operation and performance.



Additional Information

Additional information to read as required.

This information is provided to increase understanding or make operation easier.

Symbol



The triangle symbol indicates precautions (including warnings).
The specific operation is shown in the triangle and explained in the text.
This example indicates a general precaution.



The filled circle symbol indicates operations that you must do.
The specific operation is shown in the circle and explained in the text.
This example shows a general precaution for something that you must do.

4. Overview

This document describes the procedures for connecting E2E-series IO-Link Proximity Sensor (hereinafter referred to as Proximity Sensor) that is connected via IO-Link to NX-series IO-Link Master Unit (NX-ILM□□□□) to CJ-series Programmable Controller + EtherNet/IP Unit (hereinafter referred to as PLC) via EtherNet/IP through EtherNet/IP Coupler Unit (NX-EIC202) to which IO-Link Master Unit is connected and also for checking their communication status - all of which are produced by OMRON Corporation.

Refer to *Section 6. Communications Settings* and *Section 7. IO-Link Connection Procedure* to understand setting methods and key points to perform cyclic communications in the IO-Link system.

In this document, a specific EtherNet/IP slave configured of EtherNet/IP Coupler Unit and IO-Link Master Unit is called "Slave Terminal".

Also, CJ-series EtherNet/IP Unit and the built-in EtherNet/IP port of CJ-series CJ2 CPU Unit are collectively called "EtherNet/IP Unit".

<Slave Terminal Configuration>

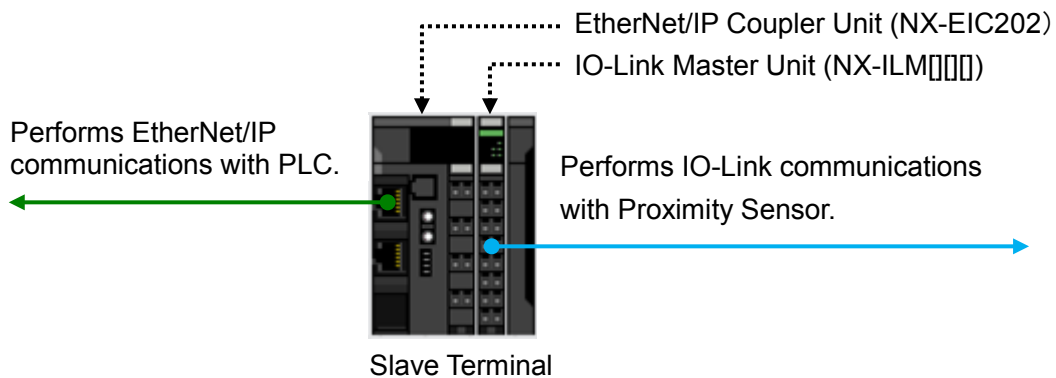

5. Applicable Devices and Device Configuration

5.1. Applicable Devices

The applicable devices are as follows:

Manufacturer	Name	Model
OMRON	CJ2 CPU Unit	CJ2[]-CPU[]
OMRON	EtherNet/IP Unit	CJ1W-EIP21 CJ2H-CPU6[]-EIP CJ2M-CPU3[]
OMRON	NX-series EtherNet/IP Coupler Unit	NX-EIC202
OMRON	NX-series IO-Link Master Unit	NX-ILM[]
OMRON	E2E-series IO-Link Proximity Sensor	E2E(Q)-[]-IL[]



Precautions for Correct Use

In this document, the devices with models and versions listed in 5.2. *Device Configuration* are used as examples of applicable devices to describe the procedures for connecting the devices and checking their connections.

You cannot use devices with versions lower than the versions listed in 5.2.

To use the above devices with models not listed in 5.2. or versions higher than those listed in 5.2., check the differences in the specifications by referring to the manuals before operating the devices.



Additional Information

This document describes the procedures for establishing the network connections.

It does not provide information on operation, installation, wiring method, device functionality, or device operation, which is not related to the connection procedures.

Refer to the manuals or contact your OMRON representative.

5.2. Device Configuration

The hardware components to reproduce the connection procedures in this document are as follows:

Personal computer (CX-One, Sysmac Studio, and CX-ConfiguratorFDT installed, OS: Windows 7)

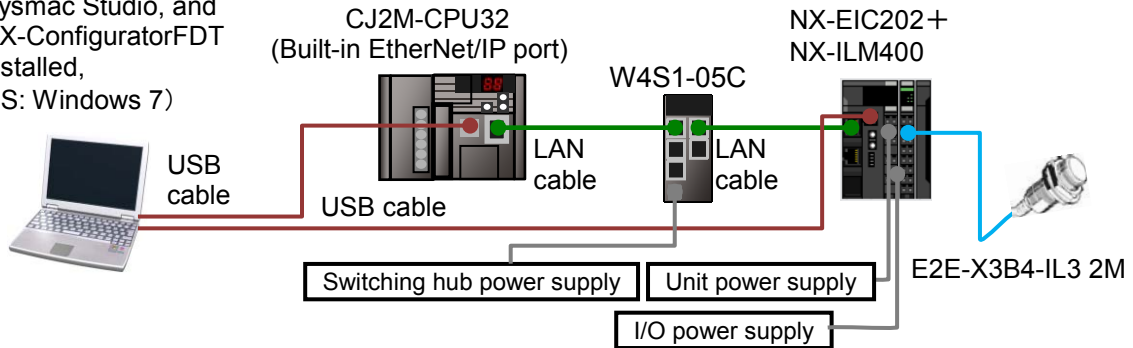

Manufacturer	Name	Model	Version
OMRON	CJ2 CPU Unit (Built-in EtherNet/IP port)	CJ2M-CPU32	Ver.2.0 (Ver.2.12)
OMRON	Power Supply Unit	CJ1W-PA202	
OMRON	Switching hub	W4S1-05C	Ver.1.00
-	Switching hub power supply (24 VDC)	-	
OMRON	CX-One	CXONE-AL□□C-V4 /AL□□D-V4	Ver.4.□□
OMRON	CX-Programmer	(Included in CX-One)	Ver.9.61
OMRON	Network Configurator	(Included in CX-One)	Ver.3.59c
-	Personal computer (OS: Windows 7)	-	
-	USB cable (for PLC) (USB 2.0 type B connector)	-	
-	LAN cable (STP (shielded, twisted-pair) cable of Ethernet category 5 or higher)	-	
OMRON	NX-series EtherNet/IP Coupler Unit	NX-EIC202	Ver.1.0
OMRON	NX-series IO-Link Master Unit	NX-ILM400	Ver.1.0
-	Unit power supply (24 VDC)	-	
-	I/O power supply (24 VDC)	-	
OMRON	Sysmac Studio NX-IO Edition	SYSMAC-NE001L	Ver.1.16
OMRON	CX-ConfiguratorFDT	(Included in Sysmac Studio)	Ver.2.2
-	USB cable (for Slave Terminal) (USB 2.0 type B connector)	-	
OMRON	IO-Link Proximity Sensor	E2E-X3B4-IL3 2M	Ver.1.00



Precautions for Correct Use

Update CX-Programmer and Network Configurator to the versions specified in this *Clause 5.2.* or to higher versions. If you use a version higher than the one specified, the procedures and related screenshots described in *Section 7.* and subsequent sections may not be applicable. In that case, use the equivalent procedures described in this document by referring the *CX-Programmer OPERATION MANUAL* (Cat. No. W446) and *Network Configurator Online Help*.



Precautions for Correct Use

Update Sysmac Studio and CX-ConfiguratorFDT to the versions specified in this *Clause 5.2.* or to higher versions. If you use a version higher than the one specified, the procedures and related screenshots described in *Section 7.* and subsequent sections may not be applicable. In that case, use the equivalent procedures described in this document by referring to the *Sysmac Studio Version 1 Operation Manual* (Cat. No. W504) and the *CX-ConfiguratorFDT Online Help*.



Additional Information

For power supply specifications available for Switching hub, refer to the *Switching Hub W4S1-series Users Manual* (Cat. No. 0969584-7).



Additional Information

For specifications of Unit and I/O power supplies for Slave Terminal, refer to the *NX-series EtherNet/IP™ Coupler Unit User's Manual* (Cat. No. W536).



Additional Information

The system configuration in this document uses USB for the connection between Personal computer and PLC. For information on how to install the USB driver, refer to *A-5 Installing the USB Driver* of the *CJ-series CJ2 CPU Unit Hardware User's Manual* (Cat. No. W472).



Additional Information

The system configuration in this document uses USB for the connection between Personal computer and Slave Terminal. For information on how to install the USB driver, refer to *A-1 Driver Installation for Direct USB Cable Connection* in *Appendices* of the *Sysmac Studio Version 1 Operation Manual* (Cat. No. W504).

6. Communications Settings

This section describes the contents of the parameter and tag data link settings that are all defined in this document.

6.1. EtherNet/IP Connection Parameters

The parameters required for connecting PLC to Slave Terminal via EtherNet/IP are shown below.

<PLC and Slave Terminal Settings>

Item	PLC (Node 1)	Slave Terminal (Node 2)
IP address	192.168.250.1	192.168.250.2
Subnet mask	255.255.255.0	255.255.255.0
Network interface setting	-	Enable Tag Data Links

6.2. IO-Link Connection Parameter

The parameter required for connecting IO-Link Master Unit and Proximity Sensor via IO-Link is shown below.

In this document, Proximity Sensor is connected to Port 1 on IO-Link Master Unit.

<IO-Link Master Unit Setting>

Item	Set value
Port1 IO-Link Device Configuration Data / Master Control	IO-Link Mode (Default)

6.3. Slave Terminal Configuration

The Slave Terminal configuration is shown below.

<Slave Terminal Configuration and Device Names>

NX Unit number	Name	Model
0	EtherNet/IP Coupler Unit	NX-EIC202
1	IO-Link Master Unit	NX-ILM400



6.4. Tag Data Link Settings

The I/O data (process data) for Proximity Sensor are allocated to the tag data links for Slave Terminal.

The following shows the content of the tag data link settings for Slave Terminal.

	Output area		Input area
D10000	(PLC to Slave Terminal) 8 bytes	D10100	(Slave Terminal to PLC) 16 bytes
D10003		D10107	

■ Output area (PLC to Slave Terminal)

Address	Bit	Function name
D10000	0 to 15	Port 1 Output Data01
D10001	0 to 15	Port 2 Output Data01
D10002	0 to 15	Port 3 Output Data01
D10003	0 to 15	Port 4 Output Data01

■ Input area (Slave Terminal to PLC)

Address	Bit	Function name
D10100	0 to 15	Slave Terminal Status
	0 to 3	-
	4	Slave Terminal Observation
	5	Slave Terminal Minor Fault
	6	Slave Terminal Partial Fault
	7	Slave Terminal Major Fault
	8 to 13	-
	14	Error Detection Flag
D10101	15	I/O Refresh Flag
	0 to 15	I/O Port Status
	0	Port1 IN Data Enable
	1	Port2 IN Data Enable
	2	Port3 IN Data Enable
	3	Port4 IN Data Enable
	4 to 13	-
14	Communication Module Error	
D10102	15	I/O Power On
	0 to 15	Port1_2 I/O Port Error Status
	0	Port1 Communication Error
	1	Port1 Short Error
	2	Port1 Compare Error
	3	Port1 Device IO Size Error
	4	Port1 Device Error
	5	Port1 Device Information
	6	Port1 PDO Error
	7	-
8 to 15	Port2 Communication Error (Same status as for Port 1)	
D10103	0 to 15	Port3_4 I/O Port Error Status
	0 to 7	Port3 Communication Error (Same status as for Port 1)
	8 to 15	Port4 Communication Error (Same status as for Port 1)

D10104	0 to 15	Port 1 Input Data01 <Stores the I/O data for Proximity Sensor.>
	0 to 7	<Stores Byte0 (PD0).>
	8 to 15	<Stores Byte1 (PD1).>
D10105	0 to 15	Port 2 Input Data01
D10106	0 to 15	Port 3 Input Data01
D10107	0 to 15	Port 4 Input Data01

■I/O data (process data) for Proximity Sensor

(Data to be stored in the address D10104 listed in the table above)

Byte0 (PD0)	割り当て Assignment	詳細 Details
	モニタ出力 Monitor Output	センシングの検出量を8bit(0-255)で出力する 詳細は6項を参照。 The sensing data are output as eight bits(0-255). For details, refer to Section 6

Byte1 (PD1)	割り当て Assignment	詳細 Details
	制御出力 Control Output	0: OFF 1: ON
	— Reserved	0
	— Reserved	0
	— Reserved	0
	不安定検出アラーム Instability Detection Alarm	0: 安定状態 Stable 1: 不安定状態 Unstable
	過接近検出アラーム Target too Close Alarm	0: 安定状態 Not close 1: 過接近状態 Too close
	— Reserved	0
	異常 Error	検出コイル断線等センサ内部に異常が発生しており、 交換が必要な場合の診断出力 This is the diagnostic output issued when an error such as disconnection of the detection coil has occurred inside the sensor and the sensor must be replaced. 0:正常 Normal (OFF) 1: 異常 Error (ON)

7. IO-Link Connection Procedure

This section describes the procedures for connecting Proximity Sensor to IO-Link Master Unit via IO-Link and for connecting PLC to Slave Terminal configured of IO-Link Master Unit on the EtherNet/IP network. The explanations of procedures for setting up PLC and Slave Terminal given in this document are based on the factory default settings.

For the initialization, refer to *Section 8. Initialization Method*.

7.1. Work Flow

Take the following steps to connect Proximity Sensor to IO-Link Master Unit via IO-Link and to connect PLC to Slave Terminal configured of IO-Link Master Unit on the EtherNet/IP network.

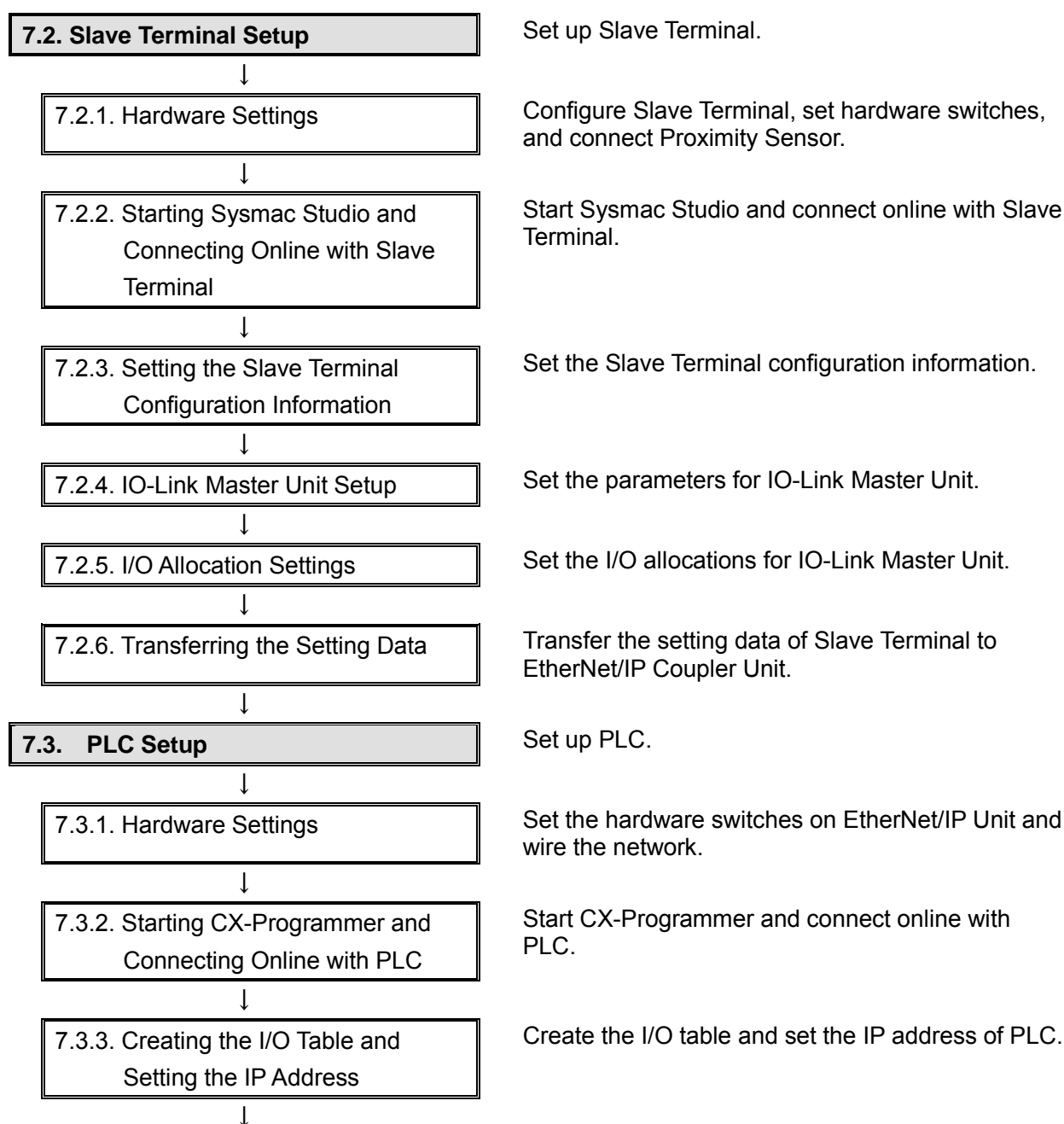

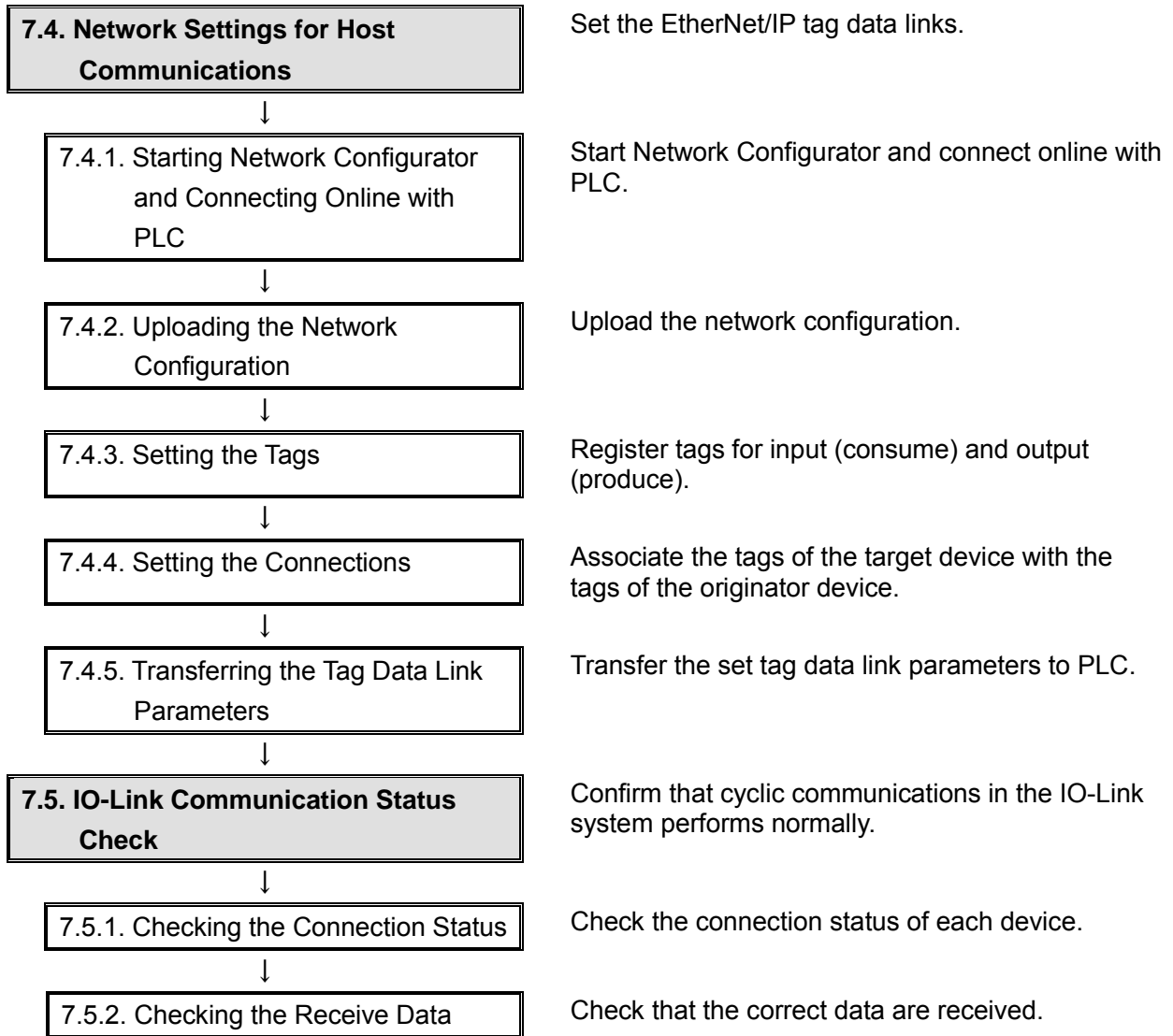

7.2. Slave Terminal Setup

Set up Slave Terminal.

7.2.1. Hardware Settings

Configure Slave Terminal, set hardware switches, and connect Proximity Sensor.



Precautions for Correct Use

Make sure that the power supply is OFF when you set up.

- 1 Make sure that EtherNet/IP Coupler Unit and IO-Link Master Unit are powered OFF.

*If either of them is ON, the settings described in the following steps and subsequent procedures may not be applicable.

- 2 Connect IO-Link Master Unit to EtherNet/IP Coupler Unit.

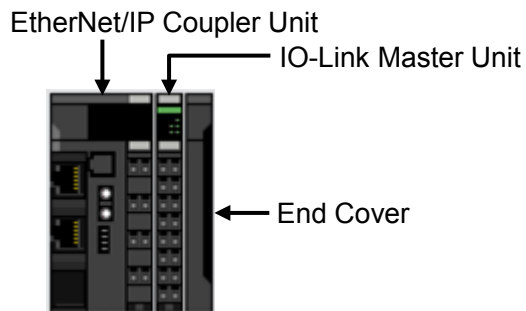

- 3 Check the position of the hardware switches on EtherNet/IP Coupler Unit by referring to the figure on the right.

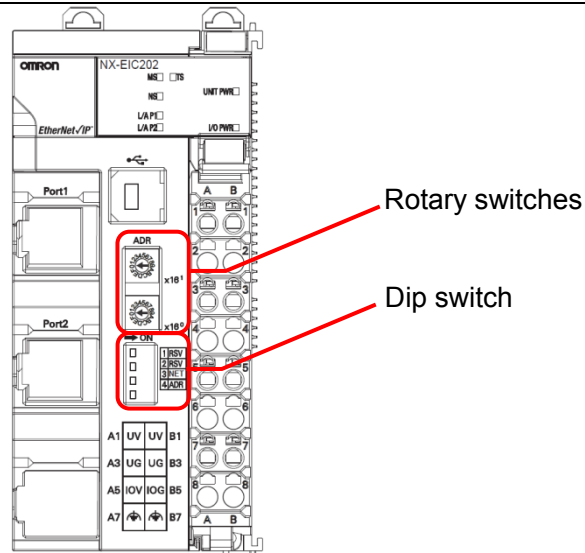

4 Check that Dip switch is set as follows:

SW3 NET: OFF
SW4 ADR: OFF

*The tag data links become enabled, and the first to third octets of the IP address are set to 192.168.250.

*The forth octet of the IP address is set by Rotary switches.

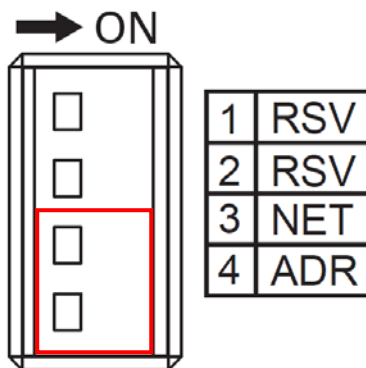

Pin	Name	Meaning
Pin 1	Reserved by the system	Keep turned OFF (The factory setting is OFF)
Pin 2		
Pin 3	Network interface setting	ON: Enable UDP/IP communications and TCP/IP communications(disable Tag Data Links) OFF: Enable Tag Data Links (disable UDP/IP communications and TCP/IP communications)
Pin 4	IP address base setting	ON: 192.168.1.[] (with [] set by rotary switches) OFF: 192.168.250.[] (with [] set by rotary switches)

5 Set Rotary switches as follows:

x16¹: 0
x16⁰: 2

*The IP address is set to 192.168.250.2.

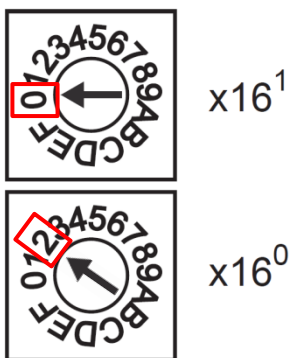

6 Connect Switching hub and Communications connector (Port 1) on EtherNet/IP Coupler Unit with a LAN cable.

Communications connector (Port 1)

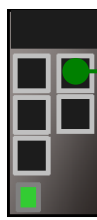

Switching hub

LAN cable

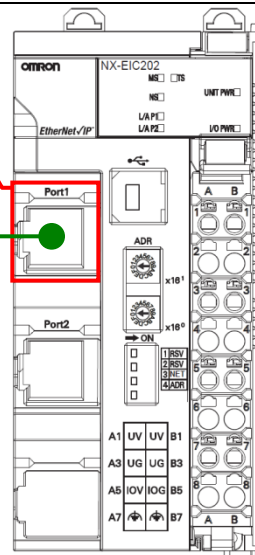

7 Connect Unit power supply and I/O power supply to Unit power supply terminals and I/O power supply terminals on EtherNet/IP Coupler Unit, respectively.

*For connecting the power supplies for NX-series Slave Terminals, refer to NX-series EtherNet/IP™ Coupler Unit User's Manual (Cat. No. W536).

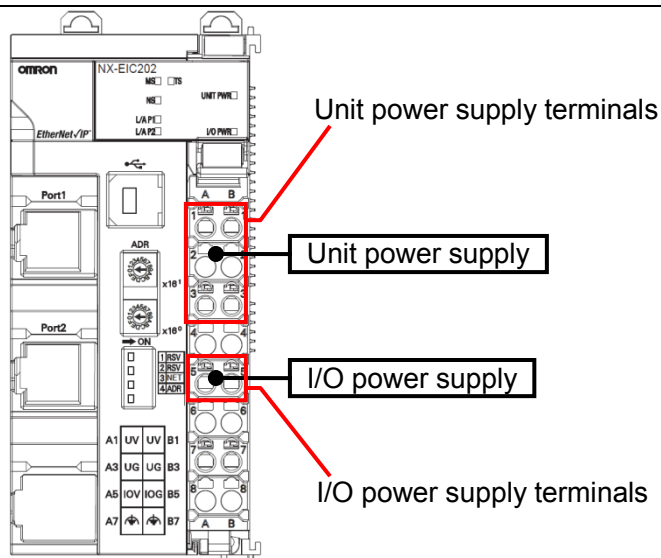

8 Connect Switching hub power supply to Switching hub.

*For connecting Switching hub power supply, refer to the Switching Hub W4S1-series Users Manual (Cat. No. 0969584-7).

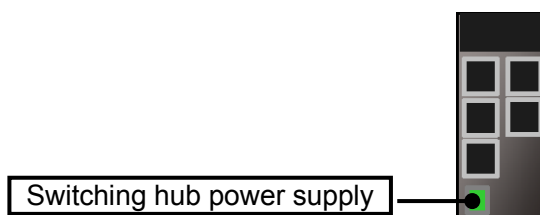

9 Connect Proximity Sensor to Port 1 on IO-Link Master Unit.

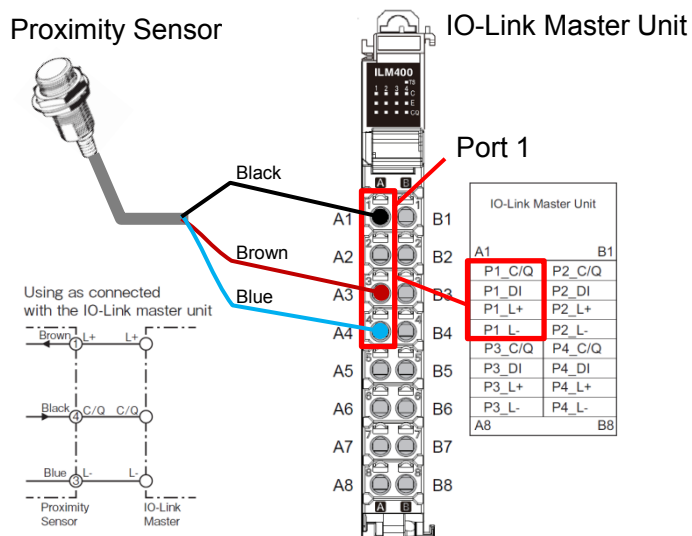

7.2.2. Starting Sysmac Studio and Connecting Online with Slave Terminal

Start Sysmac Studio and connect online with Slave Terminal.

Install Sysmac Studio and the USB driver on Personal computer beforehand.

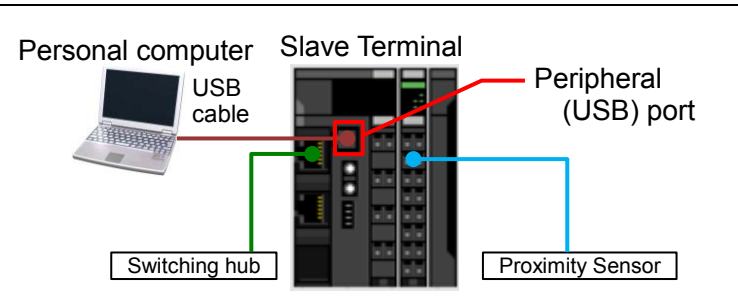
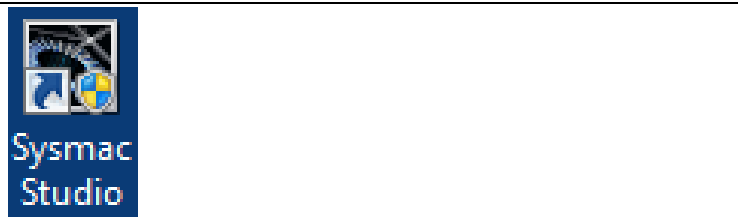
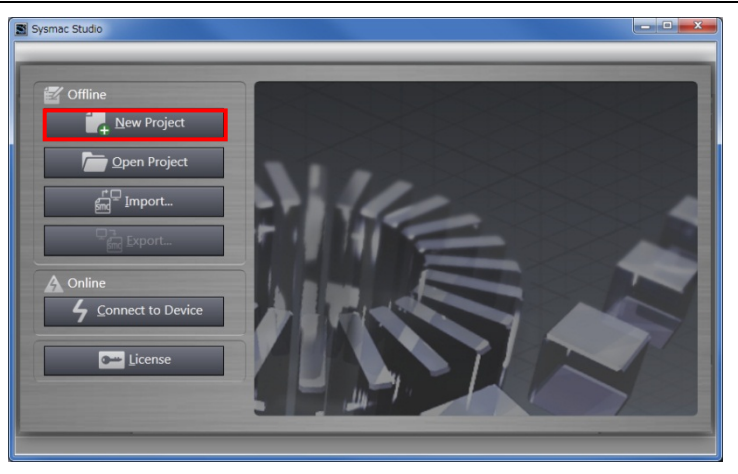
<p>1 Connect the peripheral USB port on Slave Terminal to Personal computer with a USB cable.</p>	 <p>The diagram illustrates the hardware setup. On the left, a 'Personal computer' (laptop) is connected to a 'Slave Terminal' (rack-mounted unit) via a 'USB cable'. A 'Switching hub' is also connected to the Slave Terminal. On the right, a 'Proximity Sensor' is connected to the Slave Terminal through a 'Peripheral (USB) port'. A red box highlights the Peripheral (USB) port on the Slave Terminal.</p>
<p>2 Turn ON Unit power supply for Slave Terminal.</p> <p>*The I/O power supply for Slave Terminal remains OFF.</p>	
<p>3 Start Sysmac Studio.</p> <p>*If the User Account Control Dialog Box is displayed at start, make a selection to start Sysmac Studio.</p>	 <p>The Sysmac Studio logo is displayed, featuring a blue square with a white 'S' and the text 'Sysmac Studio' below it.</p>
<p>4 Sysmac Studio starts. Click New Project.</p>	 <p>The screenshot shows the Sysmac Studio software interface. The 'Offline' section contains buttons for 'New Project', 'Open Project', 'Import...', and 'Export...'. The 'Online' section contains buttons for 'Connect to Device' and 'License'. The 'New Project' button is highlighted with a red box.</p>

- 5 The Project Properties Dialog Box is displayed.
Enter a project name.

*In this document, New Project is used as the project name.

Select the following device category and the device to use in the Select Device Area.

- Category: **Slave Terminal**
- Device: **EtherNet/IP Coupler**

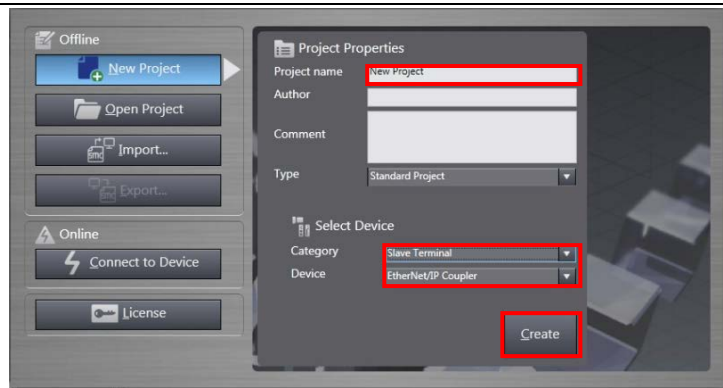

Click **Create**.

- 6 The New Project is displayed.

The following panes are displayed in this window.

- Left: Multiview Explorer
- Top right: Toolbox
- Top middle: Edit Configuration Pane

The following tabs are displayed in the bottom middle of this window.

- Output Tab Page
- Build Tab Page

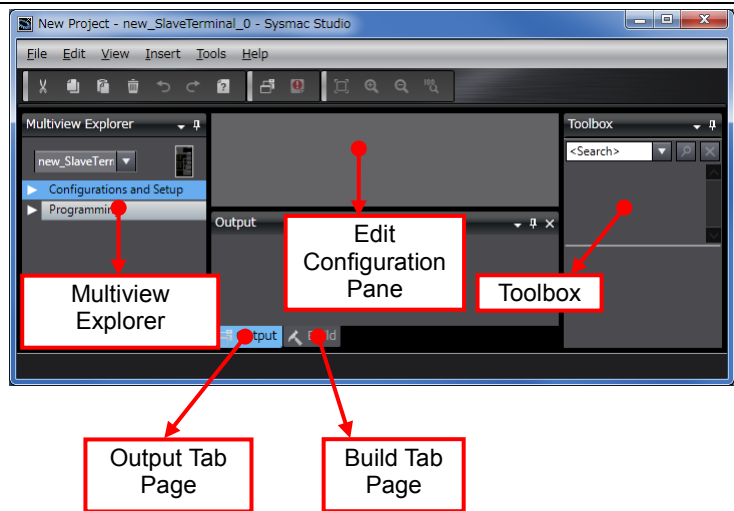

- 7 Double-click **NX-EIC202** under **Configurations and Setup - EtherNet/IP** in the Multiview Explorer.

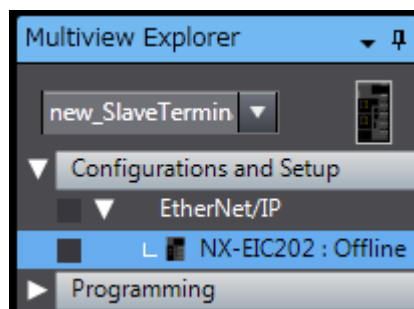

- 8 The EIP : NX-EIC202 (Master) Tab Page is displayed in the Edit Configuration Pane. Select the device icon of EtherNet/IP Coupler Unit (Unit 0) and click **Online**.

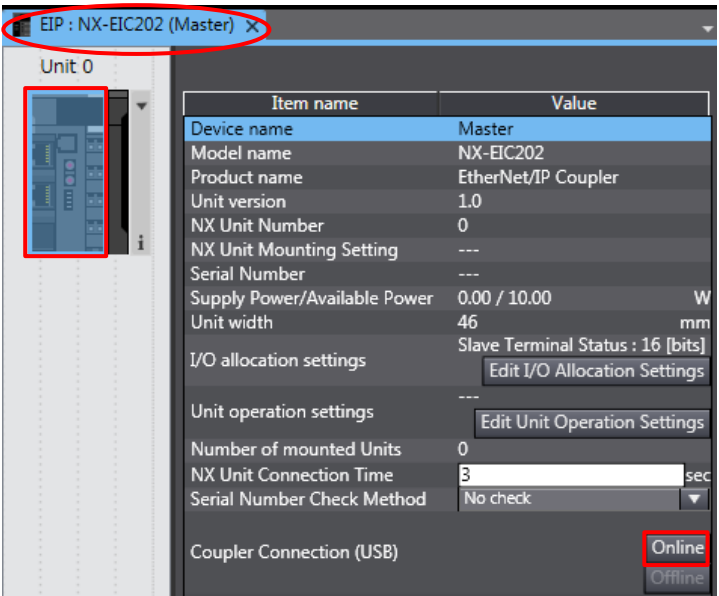

Item name	Value
Device name	Master
Model name	NX-EIC202
Product name	EtherNet/IP Coupler
Unit version	1.0
NX Unit Number	0
NX Unit Mounting Setting	---
Serial Number	---
Supply Power/Available Power	0.00 / 10.00 W
Unit width	46 mm
I/O allocation settings	Slave Terminal Status : 16 [bits] Edit I/O Allocation Settings
Unit operation settings	---
	Edit Unit Operation Settings
Number of mounted Units	0
NX Unit Connection Time	3 sec
Serial Number Check Method	No check
Coupler Connection (USB)	Online Offline

- 9 The dialog box on the right is displayed. Check the contents and click **OK**.

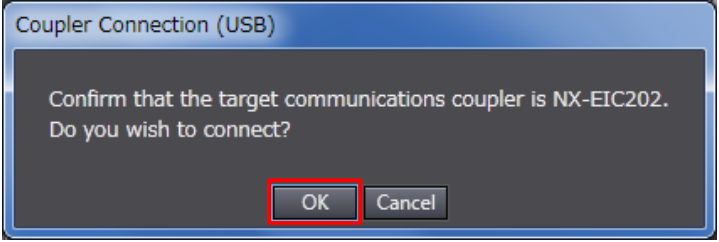

- 10 When an online connection is established, a yellow bar is displayed under the toolbar.



7.2.3. Setting the Slave Terminal Configuration Information

Set the Slave Terminal configuration information.

- 1 Right-click the device icon of EtherNet/IP Coupler Unit (Unit 0) and select **Compare and Merge with Actual Unit Configuration**.

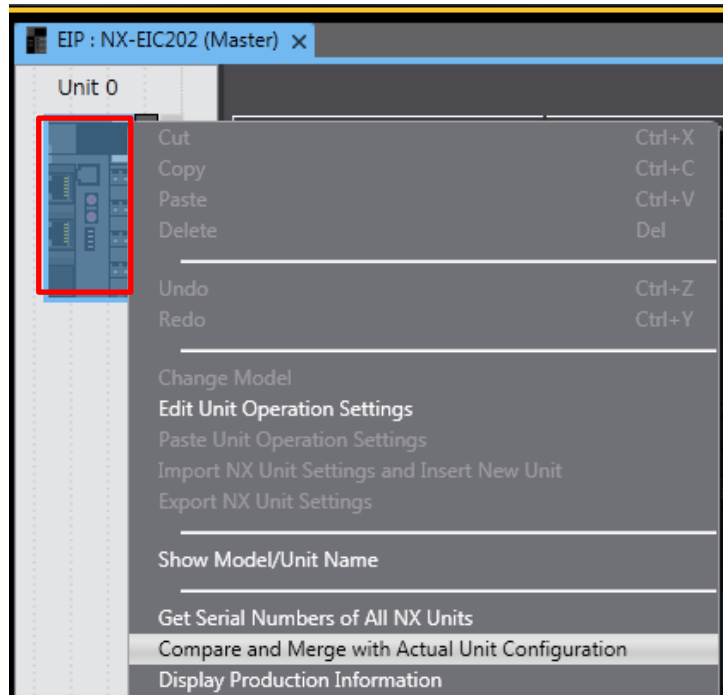

- 2 The Compare and Merge with Actual Unit Configuration Dialog Box is displayed. Check that IO-Link Master Unit is displayed in Actual Unit Configuration and that Added is shown in the *Result* Column.

Click **Apply Actual Unit Configuration**.

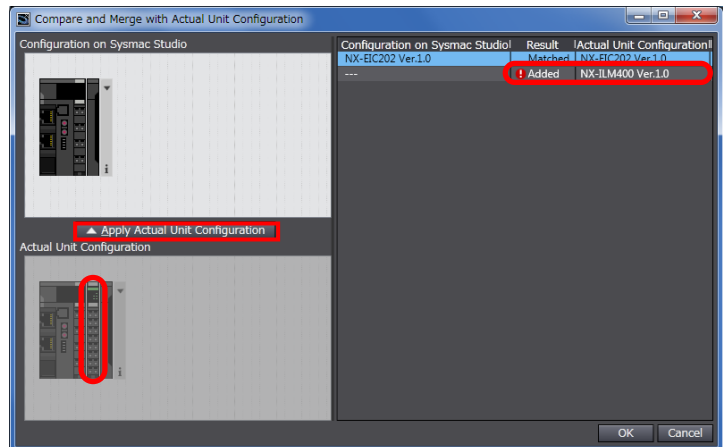

- 3 Check that IO-Link Master Unit is displayed in Configuration on Sysmac Studio and that Matched is shown in the *Result* Column.

Click **OK**.

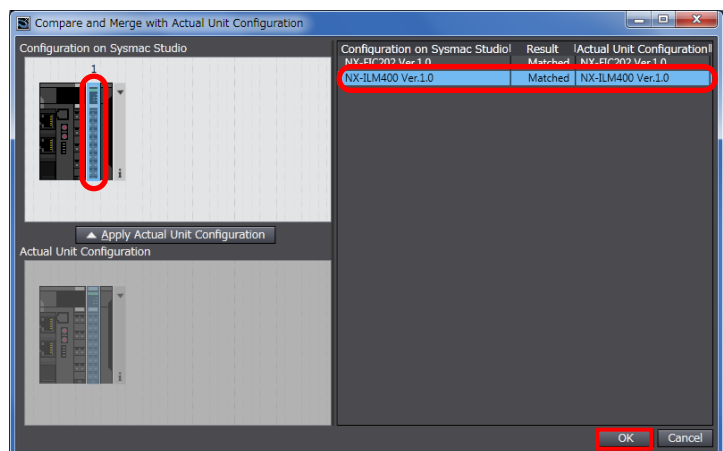

- 4 The IO-Link Master Unit is added next to EtherNet/IP Coupler Unit on the EIP : NX-EIC202 (Master) Tab Page.

Select the device icon of EtherNet/IP Coupler Unit (Unit 0) and click **Offline**.

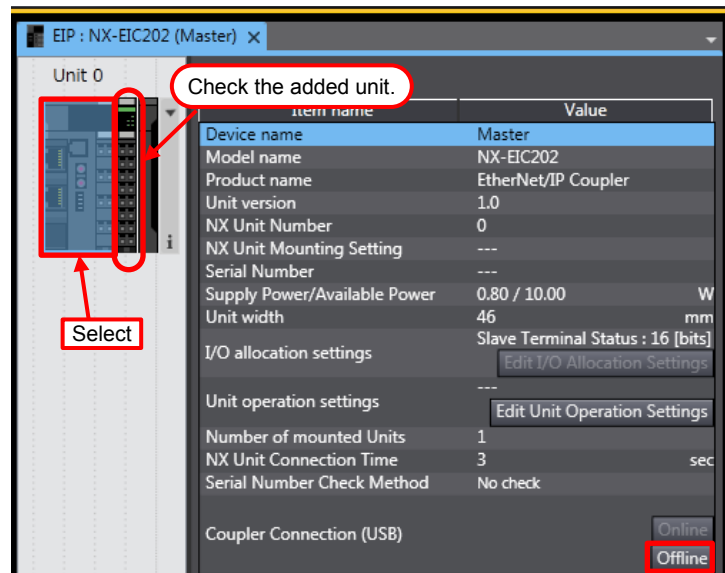

- 5 Check that EtherNet/IP Coupler Unit goes Offline.
The yellow bar under the toolbar disappears when offline.

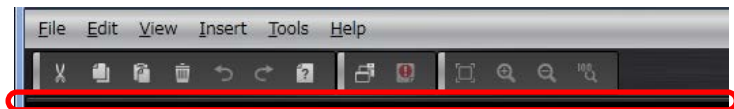

7.2.4. IO-Link Master Unit Setup

Set the parameters for IO-Link Master Unit.

In this document, the default values are used for the parameter settings of IO-Link Master Unit. Check that IO-Link Mode is set as the communications mode for Port 1 to which Proximity Sensor is connected.



Additional Information

If you use the functions such as the connected device verification and the backup and restoration of parameter settings in IO-Link devices, refer to the *NX-series IO-Link Master Unit User's Manual* (Cat. No. W567) and the *IO-Link System User's Manual* (Cat. No. W570).

<p>1 Select the device icon of IO-Link Master Unit (NX Unit number 1) on the EIP : NX-EIC202 (Master) Tab Page. Click Edit Unit Operation Settings.</p>															
<p>2 The Unit 1[EIP]:NX-ILM400(N1) Unit Operation Settings Tab Page is displayed.</p>	<table border="1" style="width: 100%; border-collapse: collapse;"> <thead> <tr> <th>Item name</th> <th>Value</th> </tr> </thead> <tbody> <tr> <td>IO-Link Device Verification Setting/Port1 De...</td> <td>No check</td> </tr> <tr> <td>IO-Link Device Verification Setting/Port2 De...</td> <td>No check</td> </tr> <tr> <td>IO-Link Device Verification Setting/Port3 De...</td> <td>No check</td> </tr> <tr> <td>IO-Link Device Verification Setting/Port4 De...</td> <td>No check</td> </tr> <tr> <td>Backup Setting/Port1 Backup Setting</td> <td>Disable</td> </tr> <tr> <td>Backup Setting/Port2 Backup Setting</td> <td>Disable</td> </tr> </tbody> </table>	Item name	Value	IO-Link Device Verification Setting/Port1 De...	No check	IO-Link Device Verification Setting/Port2 De...	No check	IO-Link Device Verification Setting/Port3 De...	No check	IO-Link Device Verification Setting/Port4 De...	No check	Backup Setting/Port1 Backup Setting	Disable	Backup Setting/Port2 Backup Setting	Disable
Item name	Value														
IO-Link Device Verification Setting/Port1 De...	No check														
IO-Link Device Verification Setting/Port2 De...	No check														
IO-Link Device Verification Setting/Port3 De...	No check														
IO-Link Device Verification Setting/Port4 De...	No check														
Backup Setting/Port1 Backup Setting	Disable														
Backup Setting/Port2 Backup Setting	Disable														
<p>3 Select ▼Port1 - Port1 IO-Link Device Configuration Data from the pull-down list (just above the column "Item name") to narrow down the parameters.</p>															

- 4 A list of Port1 IO-Link Device Configuration Data is displayed. Check that IO-Link Mode is selected as the set value of Port1 IO-Link Device Configuration Data/Master Control.

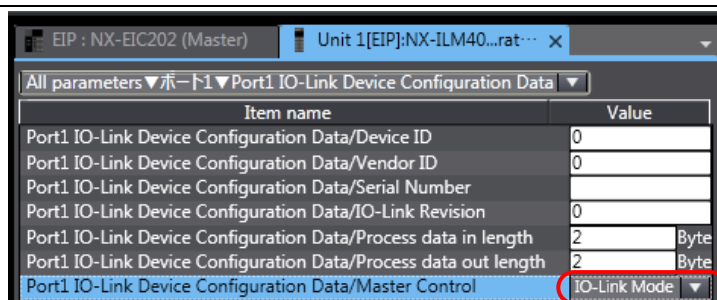

Item name	Value
Port1 IO-Link Device Configuration Data/Device ID	0
Port1 IO-Link Device Configuration Data/Vendor ID	0
Port1 IO-Link Device Configuration Data/Serial Number	
Port1 IO-Link Device Configuration Data/IO-Link Revision	0
Port1 IO-Link Device Configuration Data/Process data in length	2 Byte
Port1 IO-Link Device Configuration Data/Process data out length	2 Byte
Port1 IO-Link Device Configuration Data/Master Control	IO-Link Mode

*If IO-Link Mode is not displayed in the *Value* Column, select the mode from the pull-down list.

7.2.5. I/O Allocation Settings

Set the I/O allocations for IO-Link Master Unit.

As the default values are used for the I/O allocations in this document, the I/O allocation settings are made without editing any of the values.



Additional Information

To save the I/O data size for unused ports, delete the I/O entries for the unused ports from the I/O allocation settings.

The Edit I/O Allocation Settings Pane is displayed by clicking **Edit I/O**

Allocation Settings shown on the right.

For information on how to edit, refer to the *IO-Link System User's Manual* (Cat. No. W570).

Item name	Value
Device name	N1
Model name	NX-ILM400
Product name	IO-Link Master Unit
Unit version	1.0
NX Unit Number	1
NX Unit Mounting Setting	Enabled
Serial Number	0x00000000
Power consumption	0.80 W
Unit width	12 mm
Port1 Output Data01	: 16 [bits]
Port2 Output Data01	: 16 [bits]
Port3 Output Data01	: 16 [bits]
Port4 Output Data01	: 16 [bits]
I/O Port Status	: 16 [bits]
Port1_2 I/O Port Error Status	: ...
Port3_4 I/O Port Error Status	: ...
Port1 Input Data01	: 16 [bits]
Port2 Input Data01	: 16 [bits]
Port3 Input Data01	: 16 [bits]
Port4 Input Data01	: 16 [bits]
Edit I/O Allocation Settings	
Unit operation settings	Edit Unit Operation Settings

7.2.6. Transferring the Setting Data

Transfer the setting data of Slave Terminal to EtherNet/IP Coupler Unit.

- 1 Select the device icon of EtherNet/IP Coupler Unit on the EIP : NX-EIC202(Master) Tab Page in the Edit Configuration Pane, and connect online with EtherNet/IP Coupler Unit in the same way as steps 8 to 10 in 7.2.2. *Starting Sysmac Studio and Connecting Online with Slave Terminal.*

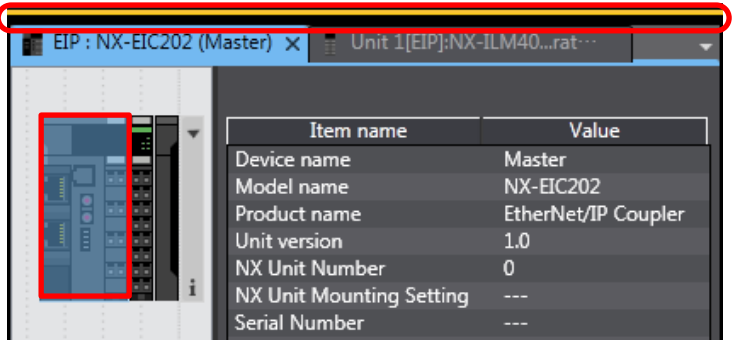

Item name	Value
Device name	Master
Model name	NX-EIC202
Product name	EtherNet/IP Coupler
Unit version	1.0
NX Unit Number	0
NX Unit Mounting Setting	---
Serial Number	---

- 2 Right-click the device icon of EtherNet/IP Coupler Unit (Unit 0) and select **Coupler Connection (USB) - Transfer to Coupler** from the menu.

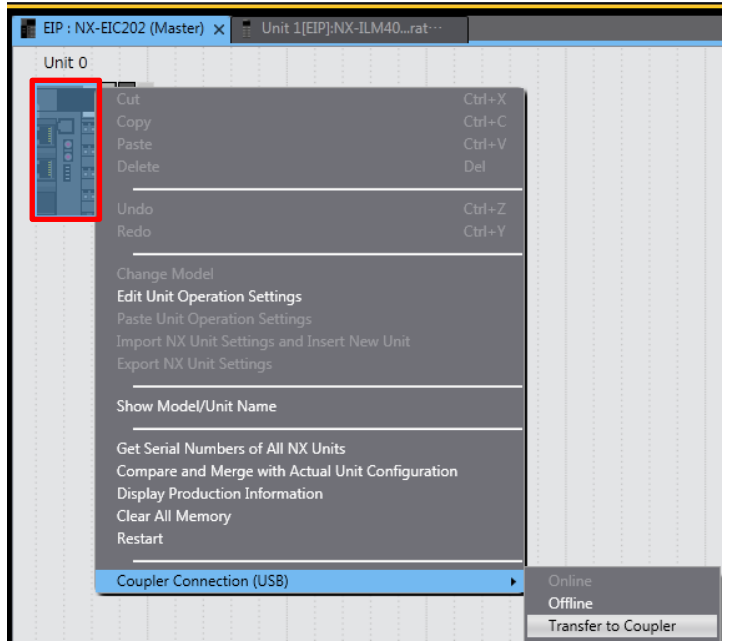

- 3 The Transfer to Coupler Dialog Box is displayed. Click **Configuration information + Unit operation settings + Unit application data**.

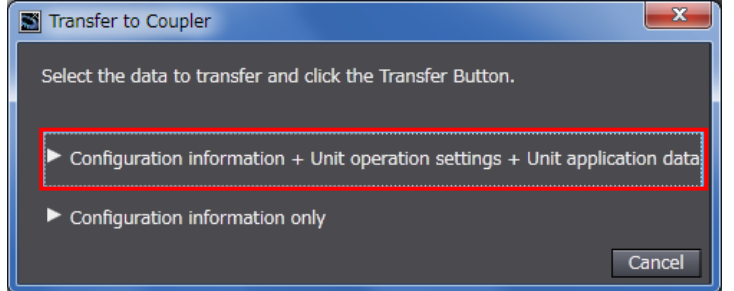

- 4 The dialog box on the right is displayed. Check the contents and click **Yes**.

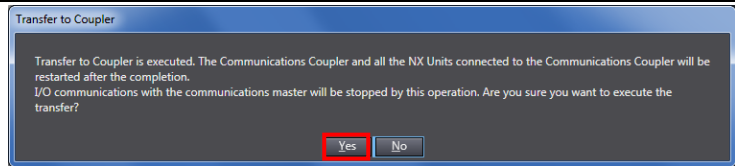

A screen is displayed stating "Transfer to Coupler".
The transfer is completed when the screen is closed.

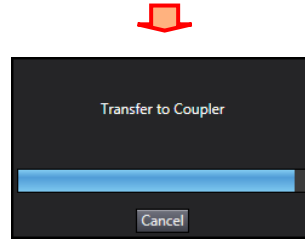

- 5 Select the device icon of EtherNet/IP Coupler Unit (Unit 0) and click **Offline**.

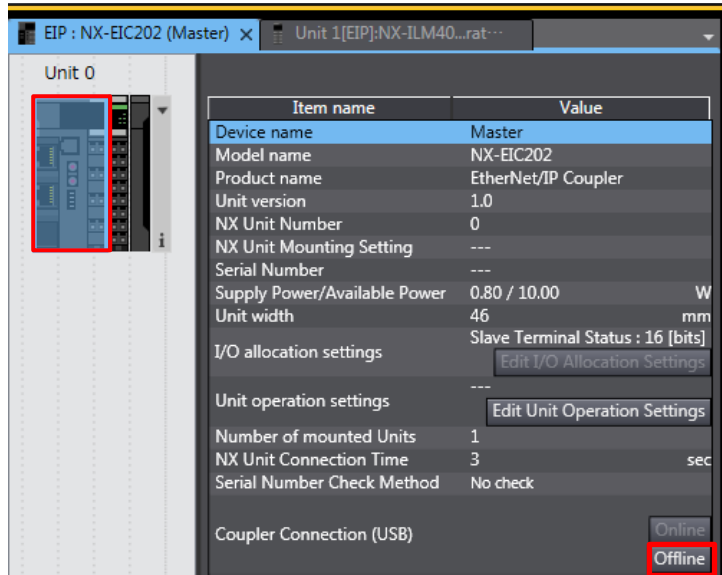

- 6 Check that EtherNet/IP Coupler Unit goes Offline.



7 Select **Exit** from the File Menu to close Sysmac Studio.

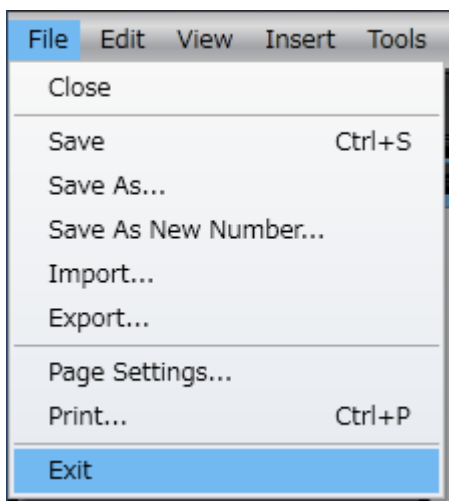

The dialog box on the right is displayed. Check the contents and click **No**.

*If desired, save the project file.

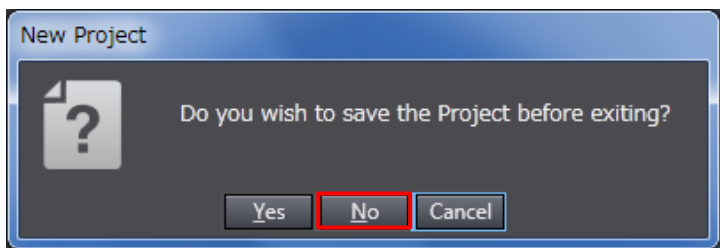

7.3. PLC Setup

Set up PLC.

7.3.1. Hardware Settings

Set the hardware switches on EtherNet/IP Unit and wire the network.



Precautions for Correct Use

Make sure that the power supply is OFF when you set up.

- 1 Make sure that PLC and Switching hub are powered OFF.

*If either of them is ON, the settings described in the following steps and subsequent procedures may not be applicable.

- 2 Check the positions of the hardware switches and the display on the front panel of EtherNet/IP Unit by referring to the figure on the right.

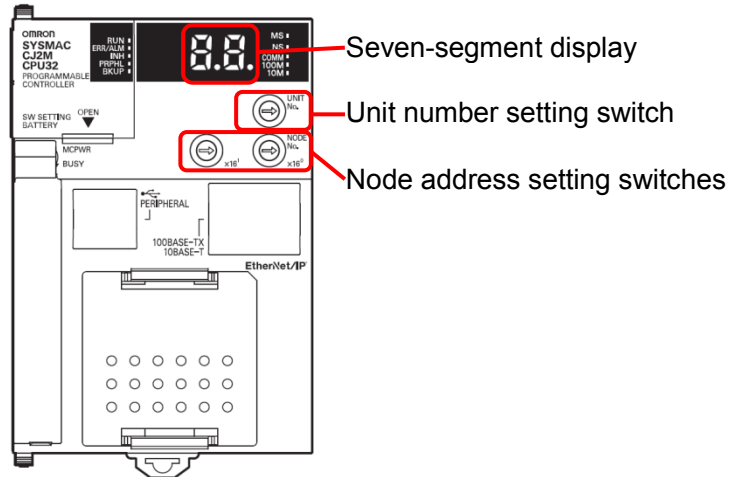

- 3 Set Unit number setting switch to 0.



- 4 Set Node address setting switches to the following default settings.

NODE No.x16¹: 0

NODE No.x16⁰: 1



*By default, the first to third octets of the local IP address are fixed to 192.168.250. The fourth octet is a value that is set with Node address setting switches.

*The IP address is set to 192.168.250.1.



5	<p>Connect a LAN cable to the EtherNet/IP port on PLC, and connect a USB cable to the USB port. As shown in 5.2. <i>Device Configuration</i>, connect Personal computer and Switching Hub to PLC.</p>	
6	<p>Turn ON PLC and Switching hub.</p>	
7	<p>The set IP address is displayed on Seven-segment display. Afterwards, the rightmost 8 bits of the IP address is displayed in hexadecimal during normal operation.</p>	

7.3.2. Starting CX-Programmer and Connecting Online with PLC

Start CX-Programmer and connect online with PLC.

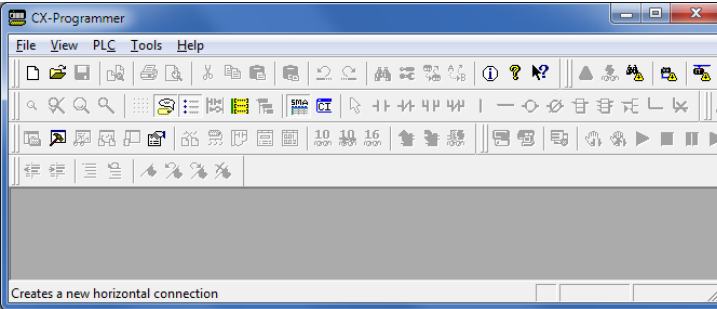
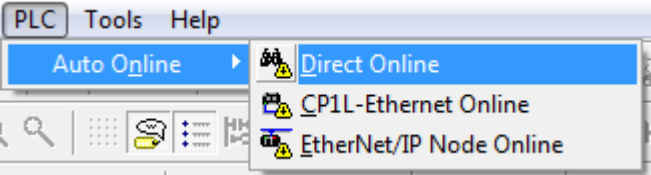
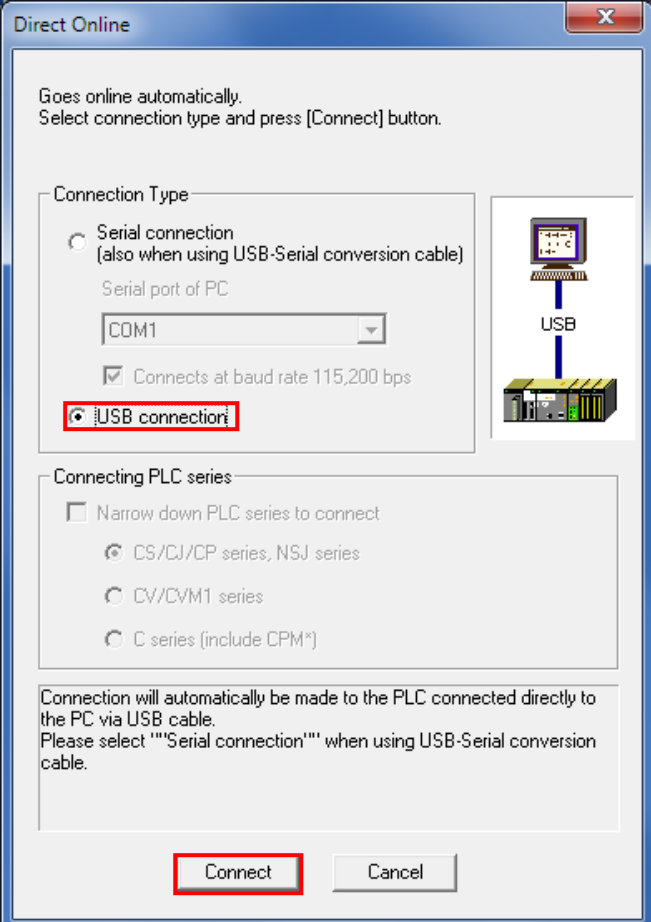
Install CX-One and the USB driver on Personal computer beforehand.

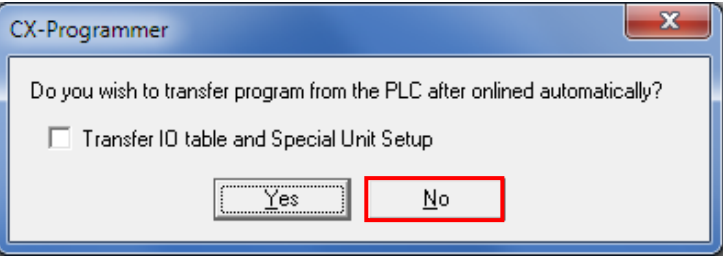
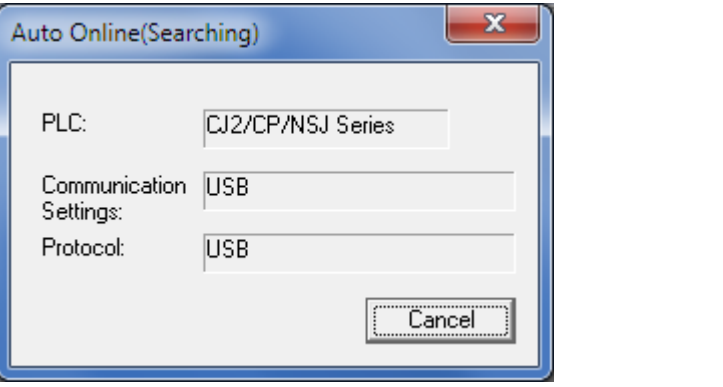
1	<p>Start CX-Programmer.</p> <p>*If the User Account Control Dialog Box is displayed at start, make a selection to start CX-Programmer.</p>	
2	<p>CX-Programmer starts.</p>	
3	<p>Select Auto Online - Direct Online from the PLC Menu.</p>	
4	<p>The Direct Online Dialog Box is displayed. Select USB connection as the connection type.</p> <p>Click Connect.</p>	

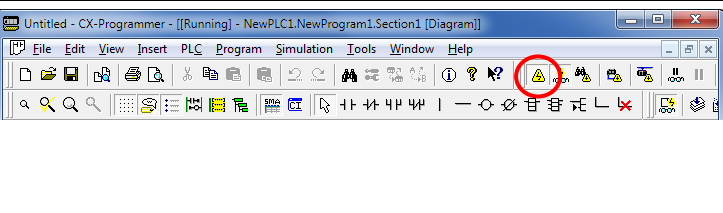
5	The dialog box on the right is displayed. Check the contents and click No .	
6	The dialog box on the right is displayed. CX-Programmer and PLC are automatically connected.	
7	<p>Check that CX-Programmer and PLC are connected online.</p> <p>*The  icon is pressed down during online connection.</p>	



Additional Information

If PLC cannot be connected online, check the cable connection.

Or, return to step 1, check the settings and repeat each step.

For details, refer to *Connecting Directly to a CJ2 CPU Unit Using a USB Cable* of the *CX-Programmer OPERATION MANUAL* (Cat. No. W446).



Additional Information

The dialog boxes explained in the subsequent procedure may not be displayed depending on the environmental settings of CX-Programmer.

For details on the environmental settings, refer to *Options and Preferences* in *CHAPTER 3 Project Reference* in *PART 1: CX-Programmer* of the *CX-Programmer OPERATION MANUAL* (Cat. No. W446).

This document explains the setting procedures when "Confirm all operations affecting the PLC" is selected.

7.3.3. Creating the I/O Table and Setting the IP Address

Create the I/O table and set the IP address of PLC.

- 1 If the operating mode of PLC is Run Mode or Monitor Mode, change it to Program Mode by following the steps below.

(1) Select **Operating Mode - Program** from the PLC Menu in CX-Programmer.

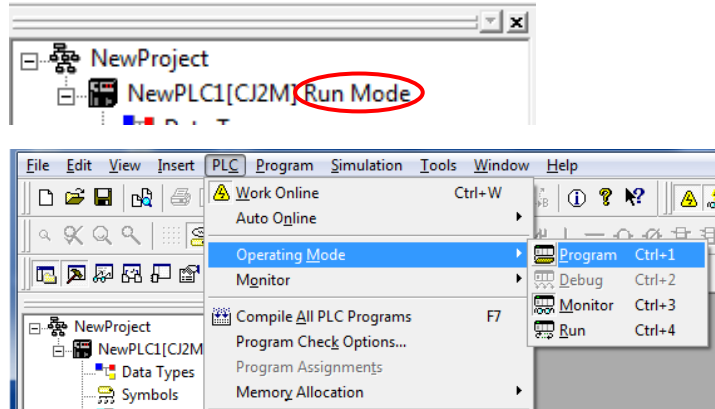

(2) The dialog box on the right is displayed. Confirm that there is no problem, and click **Yes**.
*Refer to *Additional Information* on the previous page for the settings concerning the dialog display.

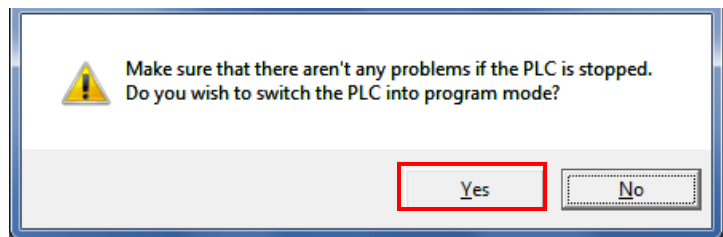

(3) Check that Stop/Program Mode is displayed on the right of the PLC model in the Project Workspace of CX-Programmer.

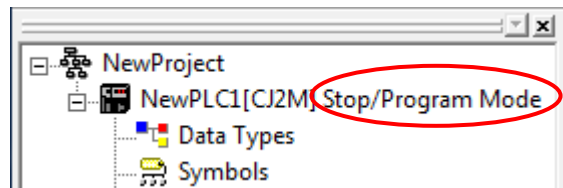

(Project Workspace)

- 2 Select **Edit - I/O Table and Unit Setup** from the PLC Menu in CX-Programmer.

The PLC IO Table Window is displayed.

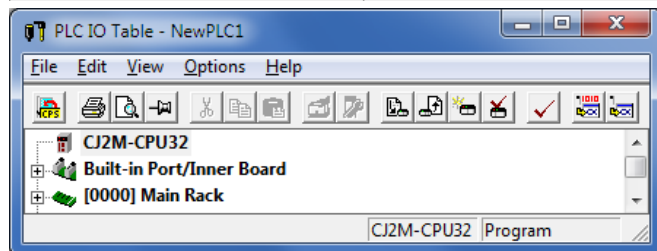
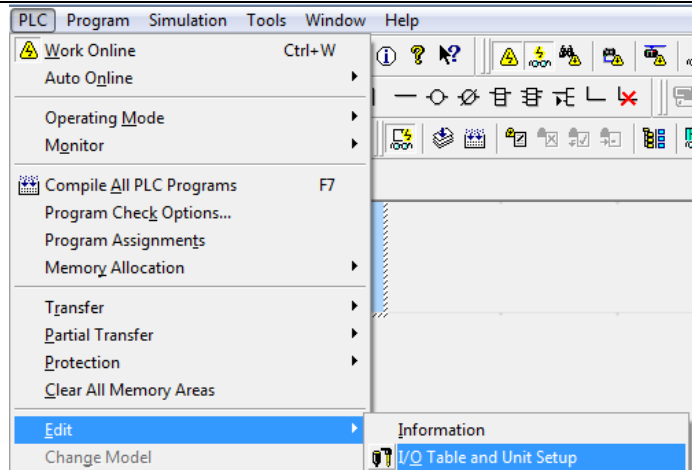



Precautions for Correct Use

The PLC is reset after creating and transferring the I/O table in step 3 and subsequent steps. Always confirm safety before creating and transferring the I/O table.

- 3 Select **Create** from the Options Menu in the PLC IO Table Window.

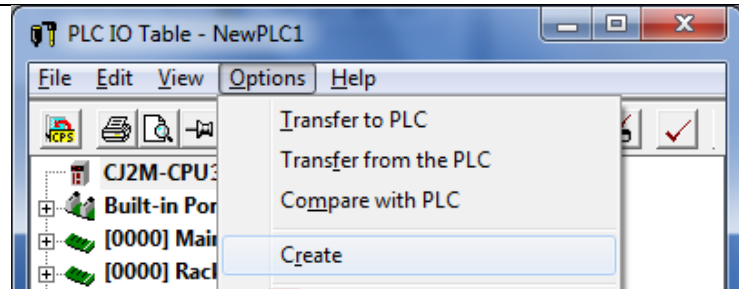

The dialog box on the right is displayed. Confirm that there is no problem, and click **Yes**.

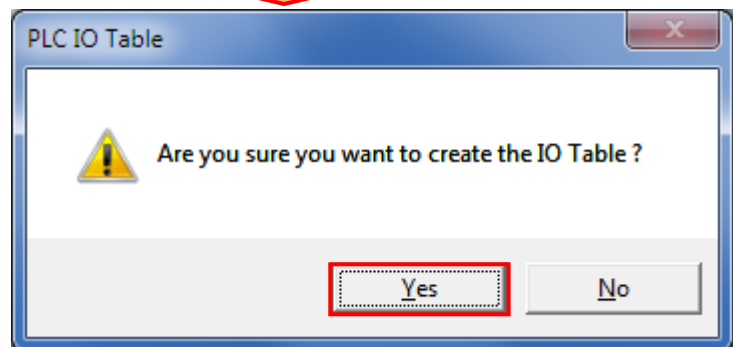

The dialog box on the right is displayed. Confirm that there is no problem, and click **Yes**.

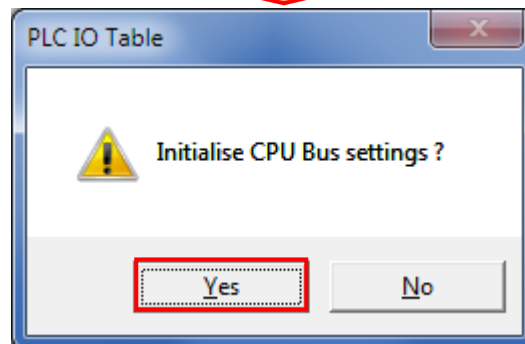

- 4 The Transfer from PLC Dialog Box is displayed. Select *IO Table* and *SIO Unit Parameters*. Click **Transfer**.

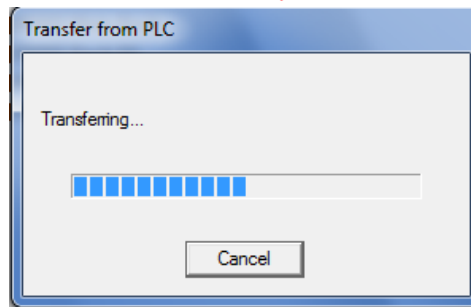
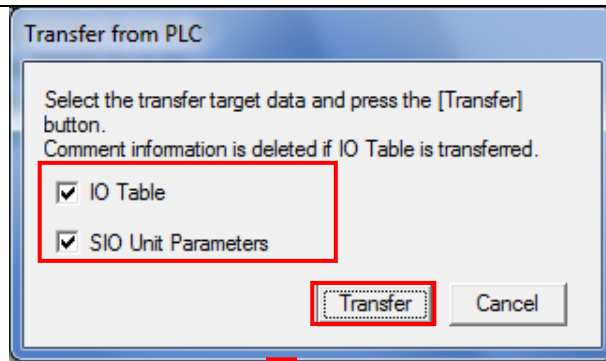

When the transfer is completed, the Transfer Results Dialog Box is displayed. Check that the transfer is successfully completed by referring to the message in the dialog box. When the I/O table is created normally, the dialog box displays as follows:
Transfer Success: 1 Unit
Transfer Unsuccessful: 0 Unit

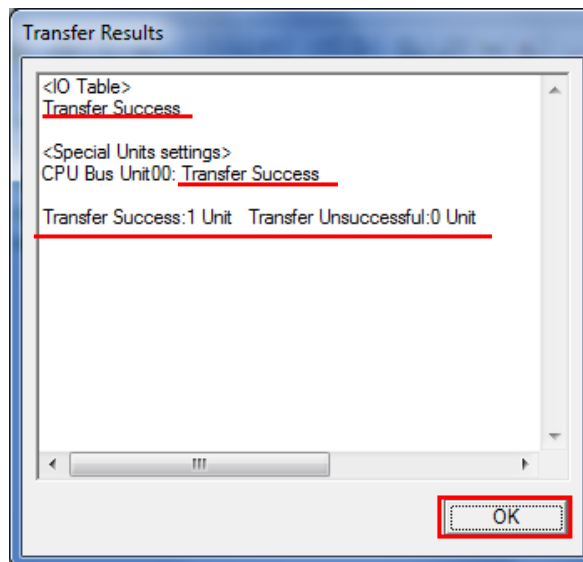

Click **OK**.

- 5 In the PLC IO Table Window, click + to the left of Built-in Port/Inner Board to display CJ2M-EIP21.

*The figure on the right displays CPU Unit (Built-in EtherNet/IP port) specified in 5.2. *Device Configuration*. If you use an other applicable EtherNet/IP Unit, the display position and name are different from the figure on the right.

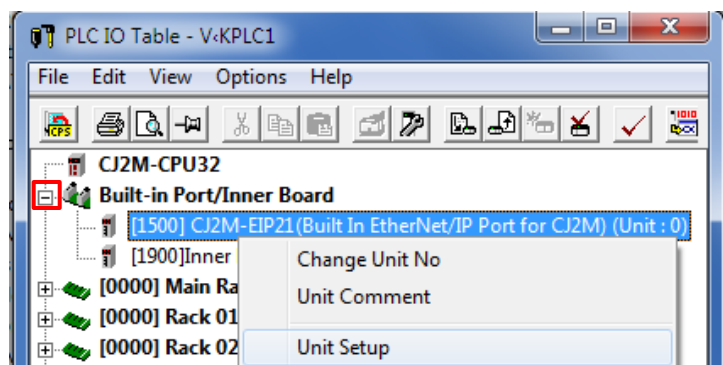

Right-click **CJ2M-EIP21** and select **Unit Setup**.

6 The Edit Parameters Dialog Box is displayed.

Select the **TCP/IP** Tab.

Make the following settings in the *IP Address* Field.

- Use the following address: *Select*
- IP address: 192.168.250.1
- Subnet mask: 255.255.255.0

Click **Transfer[PC to Unit]**.

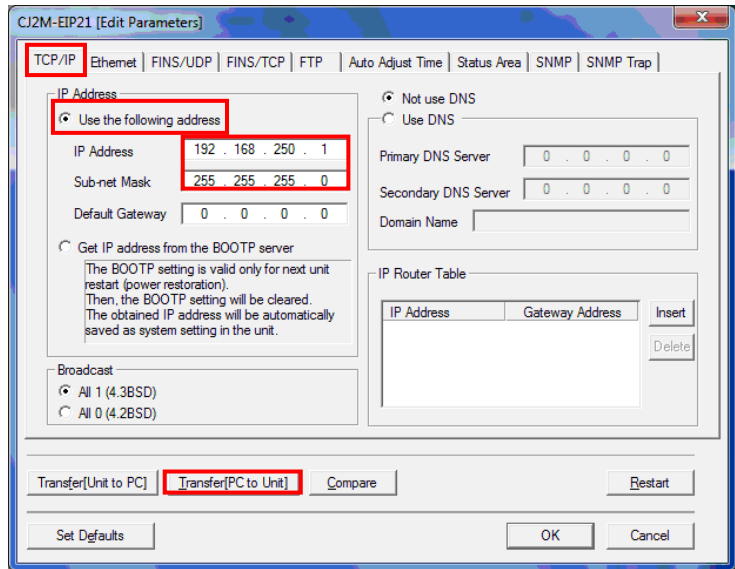

7 The dialog box on the right is displayed. Confirm that there is no problem, and click **Yes**.

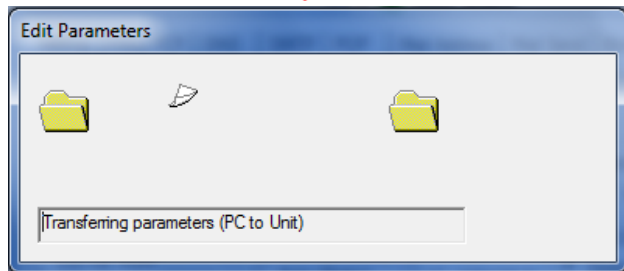
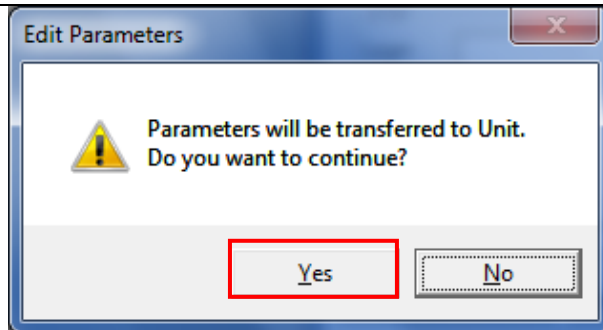

Check that a message is displayed stating "Transfer successful". Click **Close**.

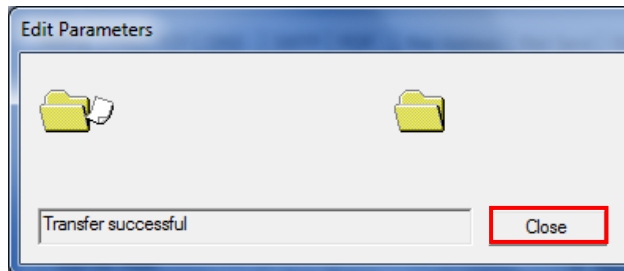

8 The dialog box on the right is displayed. Check the contents and click **Yes**.

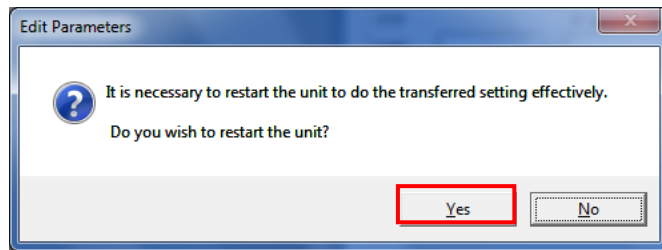

When the Unit is restarted, the dialog box on the right is displayed. Check the contents and click **OK**.

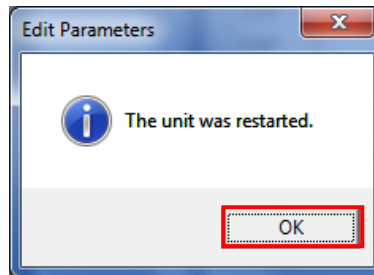

9 Click **Compare** to check that the IP address is correctly changed.

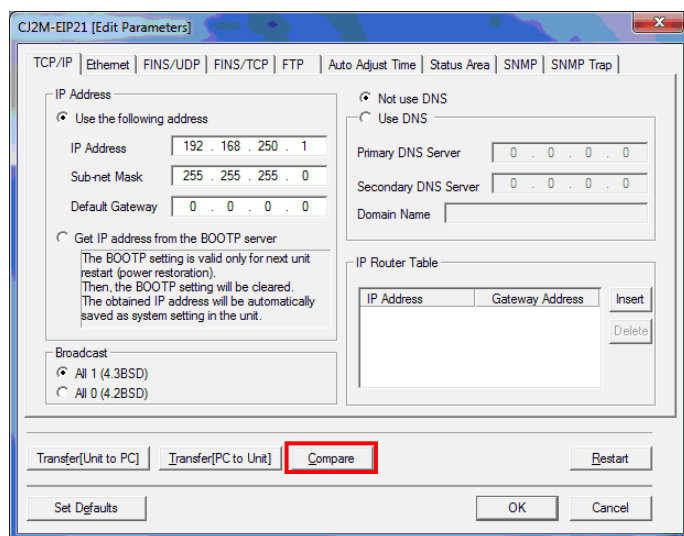

10 Check that a message is displayed stating "Compare successful". Click **Close**.

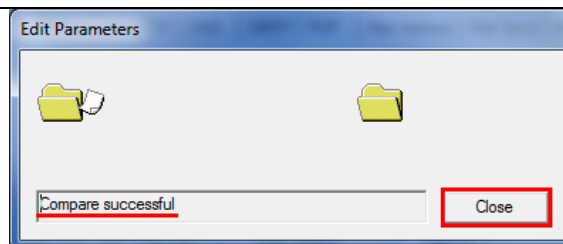

11 Click **OK** in the Edit Parameters Dialog Box.

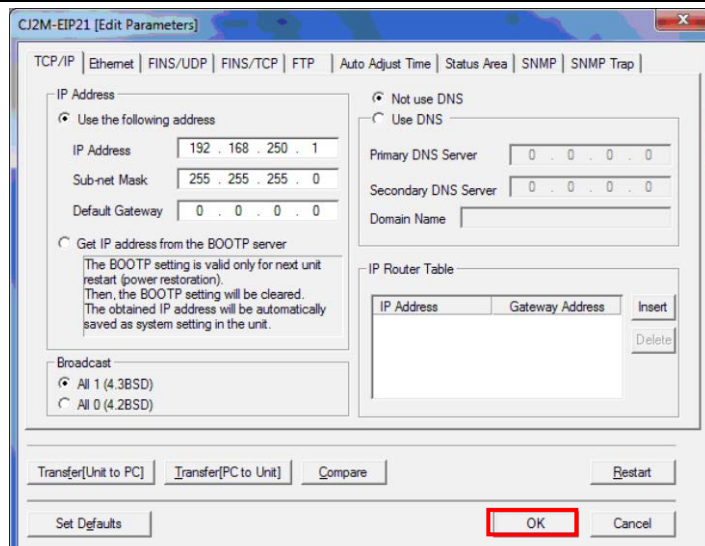

7.4. Network Settings for Host Communications

Set the EtherNet/IP tag data links.

7.4.1. Starting Network Configurator and Connecting Online with PLC

Start Network Configurator and connect online with PLC.

- 1 Right-click **CJ2M-EIP21** in the PLC IO Table Window, and select **Start Special Application - Start with Settings Inherited**.

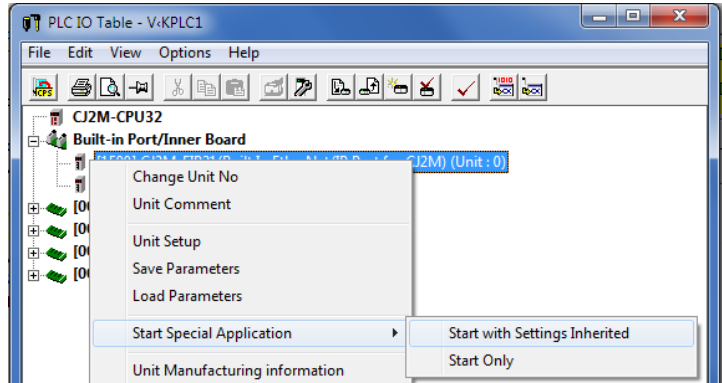

The Select Special Application Dialog Box is displayed. Select *Network Configurator* and click **OK**.

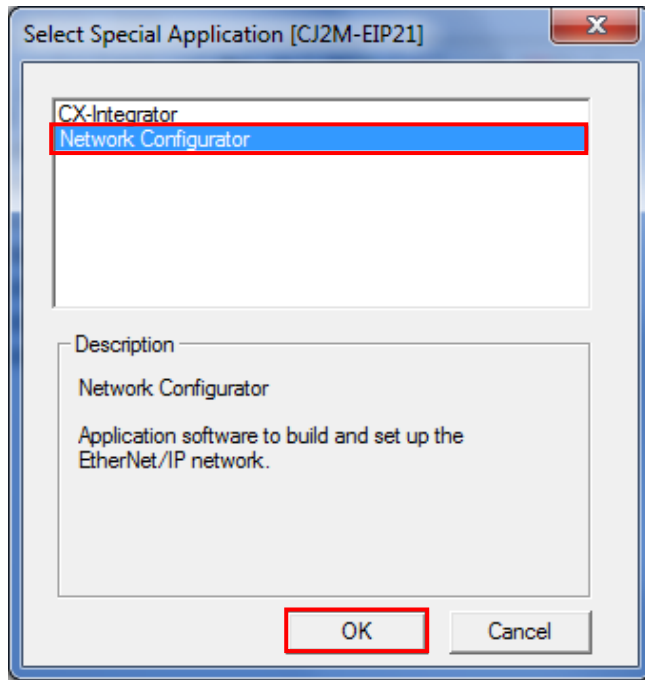

- 2 Network Configurator starts. The following panes are displayed in this window.

Left: Hardware List
Right: Network Configuration Pane

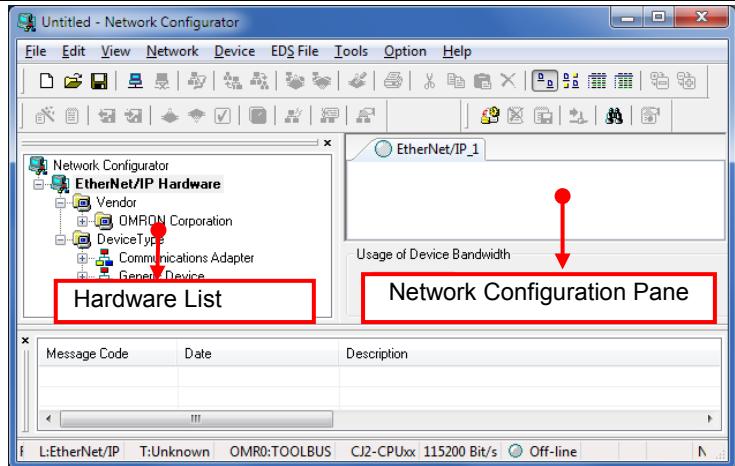



Precautions for Correct Use

Check that the LAN cables are connected before performing the following steps.
If they are not connected, turn OFF each of the devices, and then connect the LAN cables.

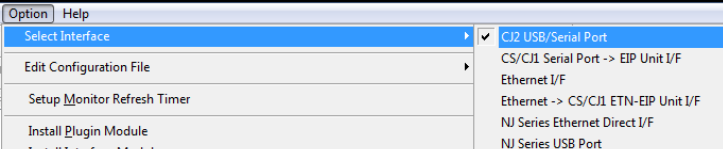
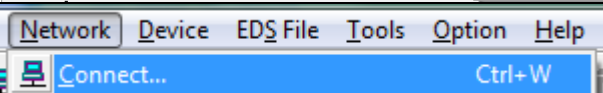
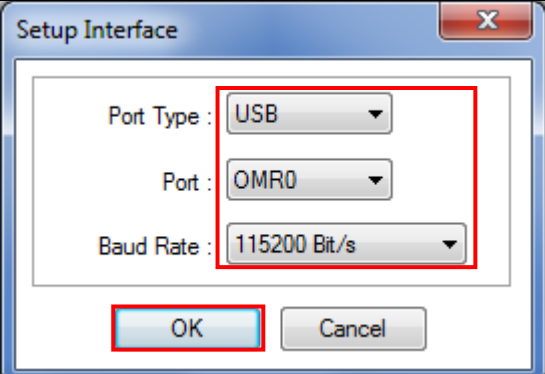
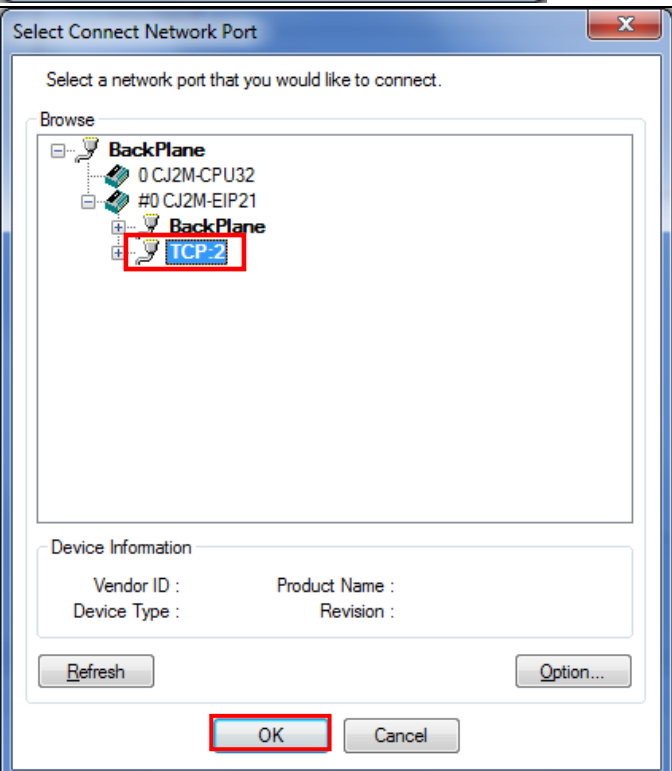
<p>3 Select Select Interface - CJ2 USB/Serial Port from the Option Menu.</p>	
<p>4 Select Connect from the Network Menu.</p>	
<p>5 The Setup Interface Dialog Box is displayed. Check that the following settings are made. Port Type: USB Port: OMR0 Baud Rate: 115200 Bit/s Click OK.</p>	
<p>6 The Select Connect Network Port Dialog Box is displayed. Select BackPlane - CJ2M-EIP21 - TCP:2. Click OK.</p>	

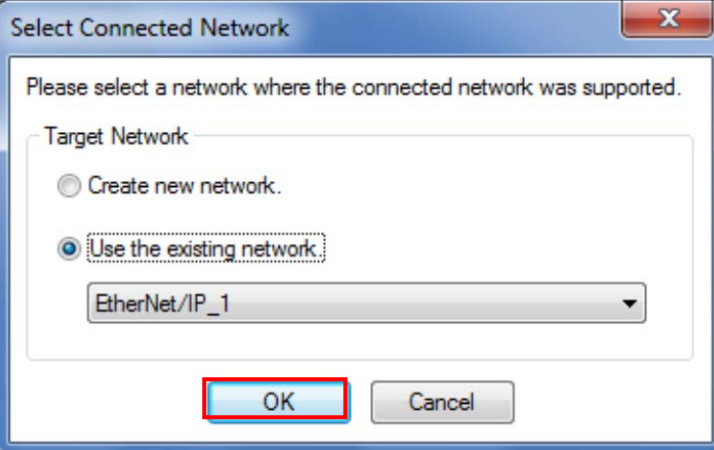
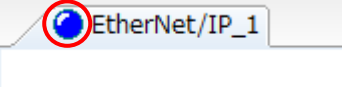
<p>7 The Select Connected Network Dialog Box is displayed. Check the contents and click OK.</p>	
<p>8 When an online connection is established normally, the color of the icon changes to blue as shown on the right.</p>	



Additional Information

If PLC cannot be connected online, check the cable connection.

Or, return to step 3, check the settings and repeat each step.

For details, refer to 6-2-9 *Connecting the Network Configurator to the Network* in SECTION 6 *Tag Data Link Functions of the EtherNet/IP™ Units OPERATION MANUAL* (Cat. No. W465).

7.4.2. Uploading the Network Configuration

Upload the network configuration.

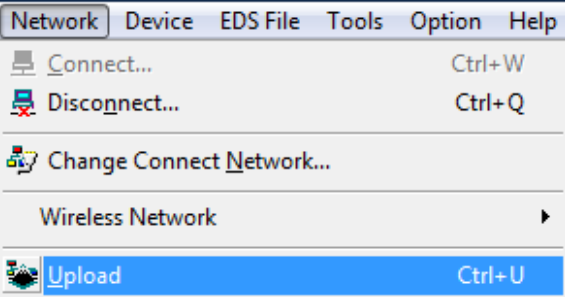
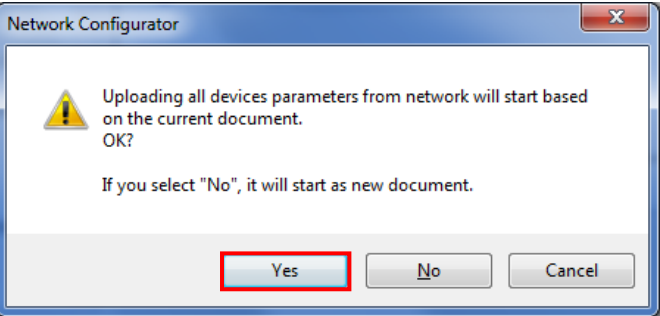
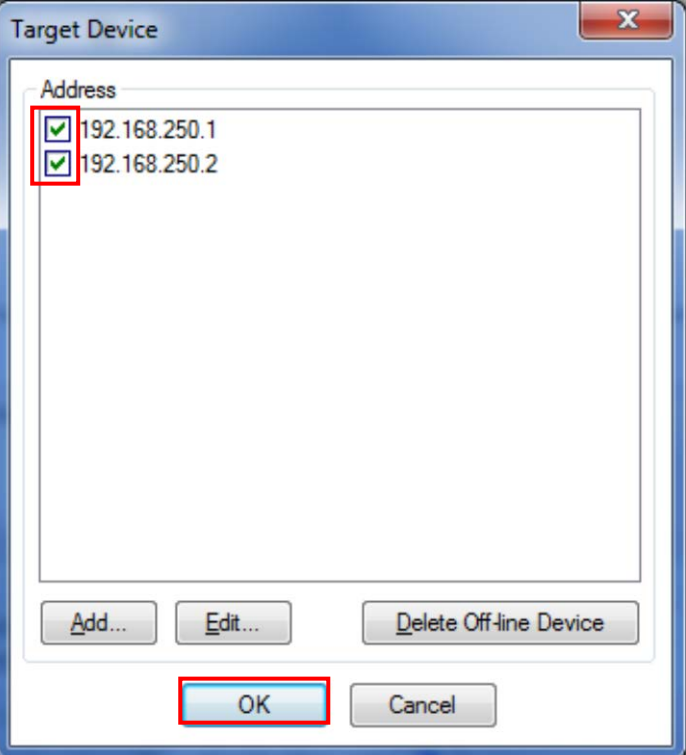
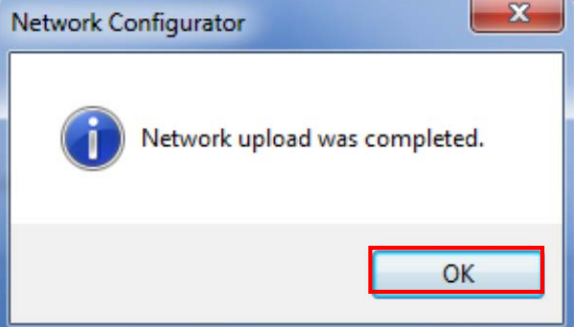
<p>1 Select Upload from the Network Menu to upload the device information on the network.</p>	
<p>2 The dialog box on the right is displayed. Confirm that there is no problem, and click Yes.</p>	
<p>3 The Target Device Dialog Box is displayed. Select 192.168.250.1 and 192.168.250.2.</p> <p>Click OK.</p> <p>*If 192.168.250.1 and 192.168.250.2 are not displayed in the dialog box, click Add to add the addresses.</p> <p>*A displayed address depends on the status of Network Configurator.</p>	
<p>4 The device parameters are uploaded. When the uploading is completed, the dialog box on the right is displayed. Check the contents and click OK.</p>	

- 5 Check that the uploaded nodes with the following IP addresses are configured in the Network Configuration Pane.

IP address of node 1:

192.168.250.1

IP address of node 2:

192.168.250.2

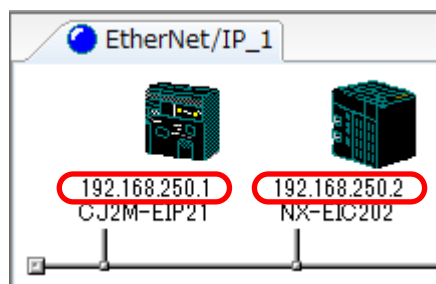

7.4.3. Setting the Tags

Register tags for input (consume) and output (produce).

The following explains the receive and send settings of the target device in order.

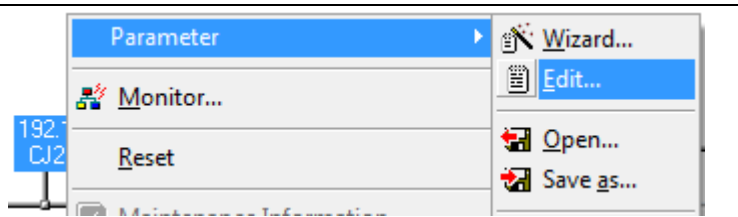
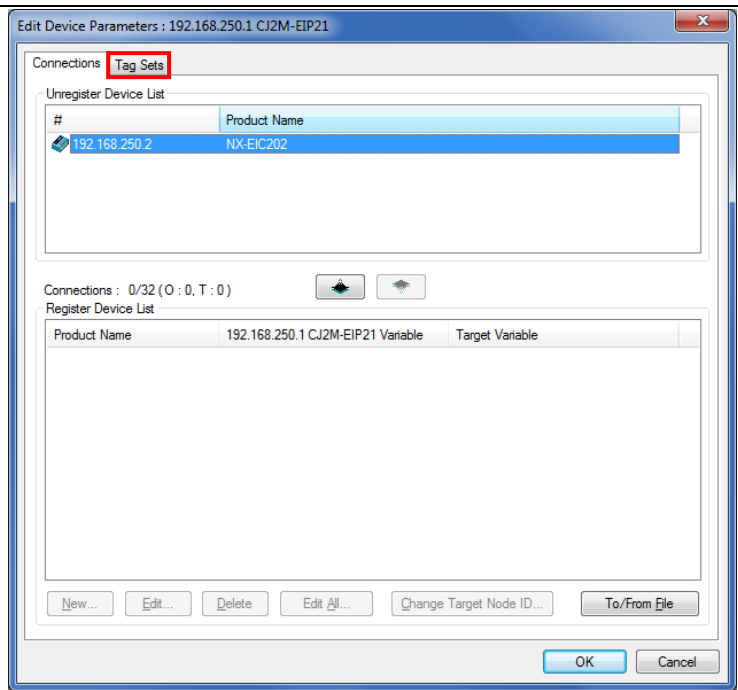
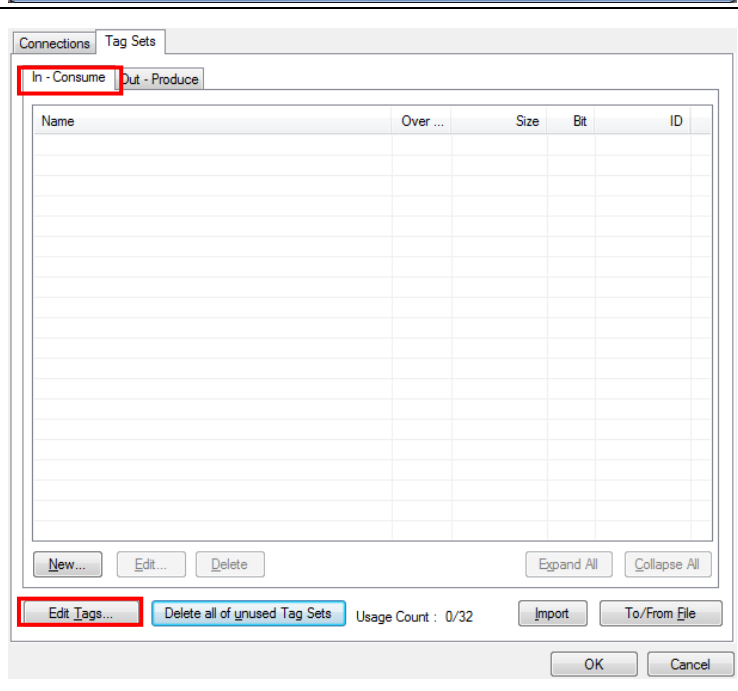
<p>1 In the Network Configuration Pane of Network Configurator, right-click the node 1 device and select Parameter - Edit.</p>	
<p>2 The Edit Device Parameters Dialog Box is displayed. Select the Tag Sets Tab.</p>	
<p>3 The data on the Tag Sets Tab Page is displayed. Select the In-Consume Tab and click Edit Tags.</p>	

- 4 The Edit Tags Dialog Box is displayed. Select the **In - Consume** Tab and click **New**. Here, register a tag for the area where the node 1 consumes data from the node 2.

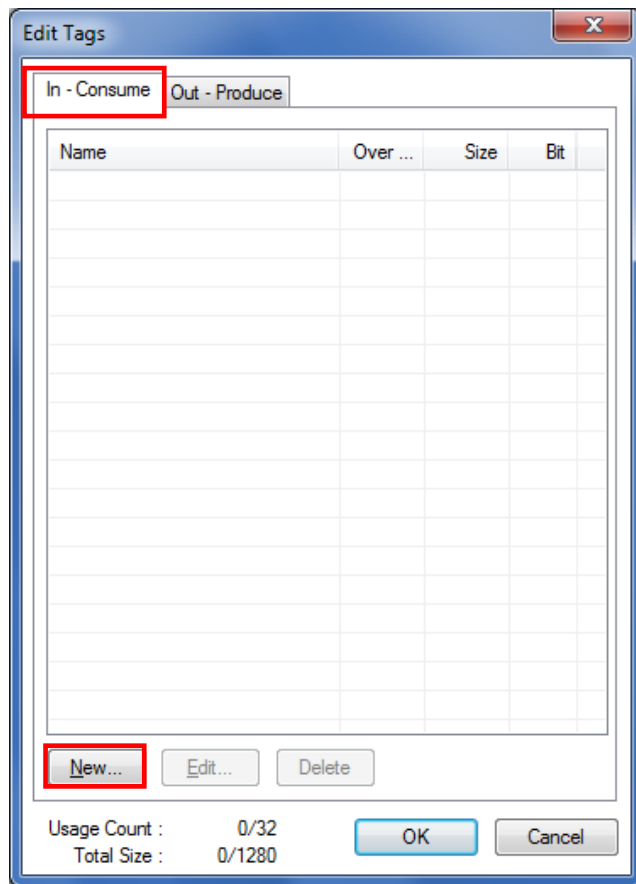

- 5 The Edit Tag Dialog Box is displayed. Enter the following values of the parameters.
 Name: *D10100* (Start address of the input data to node 1)
 Size: *16* (Byte)

After entering, click **Regist**.

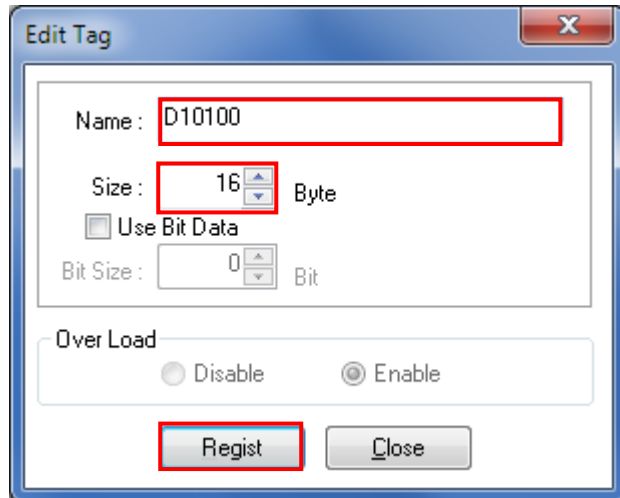

- 6 The Edit Tag Dialog Box is displayed again. Click **Close**.



- 7 Select the **Out - Produce** Tab and click **New**.
Here, register a tag for the area where the node 1 produces data to the node 2.

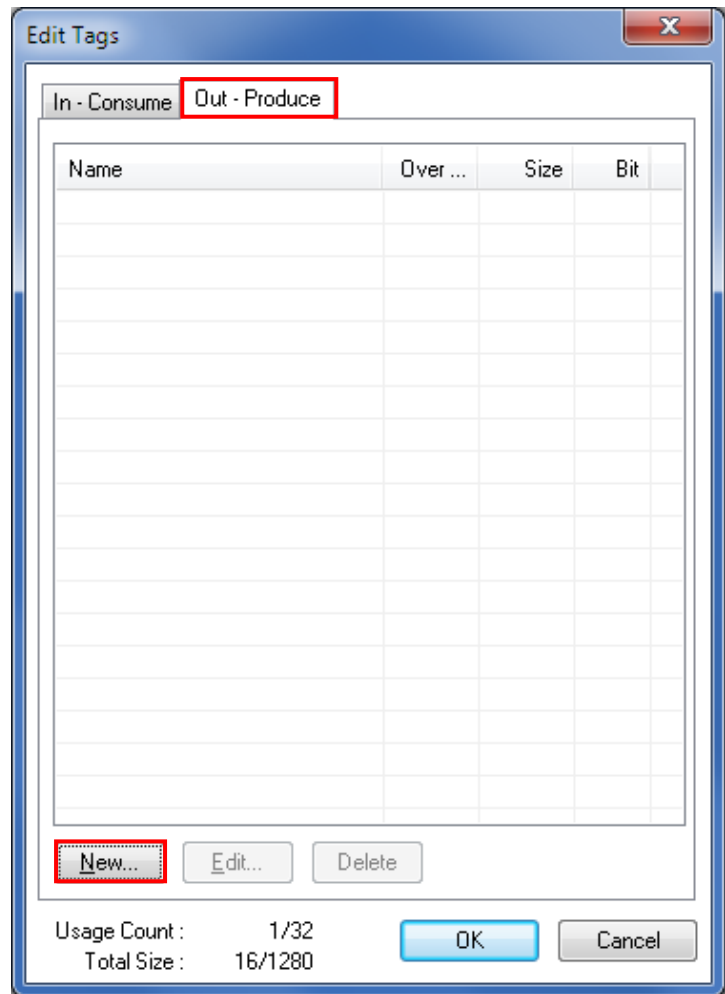

- 8 The Edit Tag Dialog Box is displayed. Enter the following values of the parameters.

Name: *D10000* (Start address of the output data from node 1)
Size: 8 (Byte)

After entering, click **Regist**.

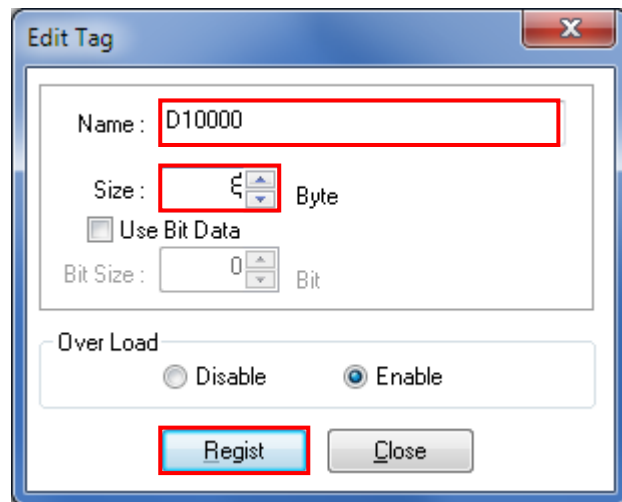

- 9 The Edit Tag Dialog Box is displayed again. Click **Close**.



10 When you finish the registration, click **OK** in the Edit Tags Dialog Box.

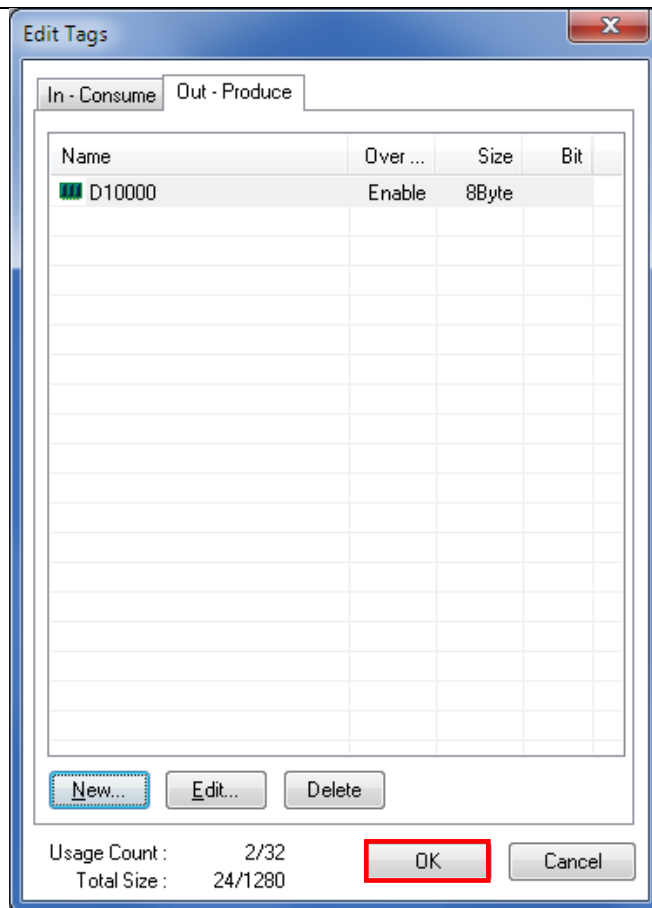

11 The dialog box on the right is displayed. Confirm that there is no problem, and click **Yes**.

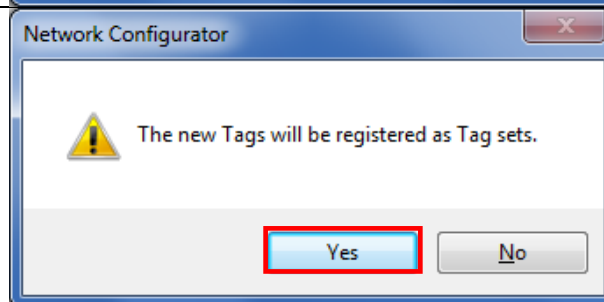

12 The Edit Device Parameters Dialog Box is displayed again. Select the **Connections** Tab.

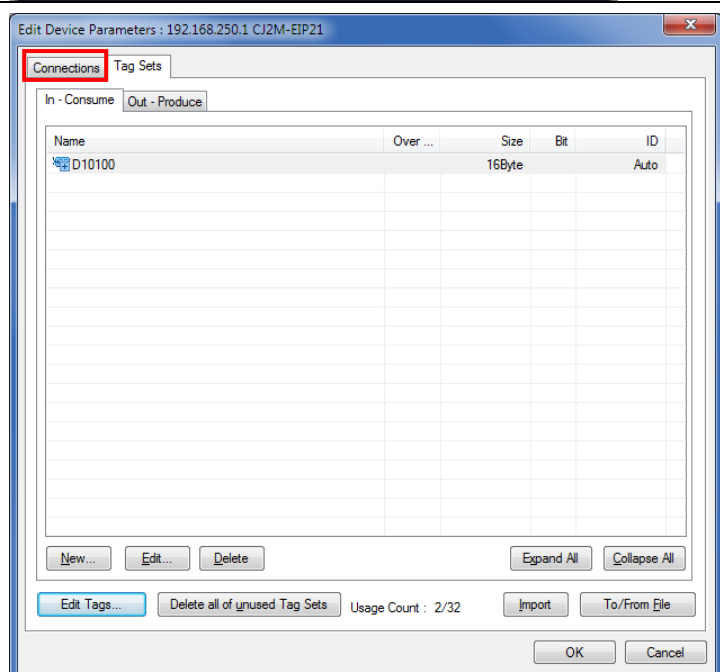

7.4.4. Setting the Connections

Associate the tags of the target device (that receives the open request) with the tags of the originator device (that requests for opening).

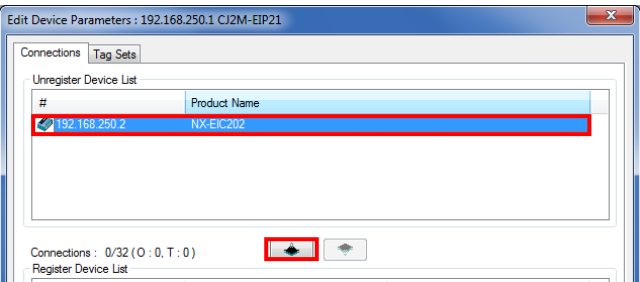
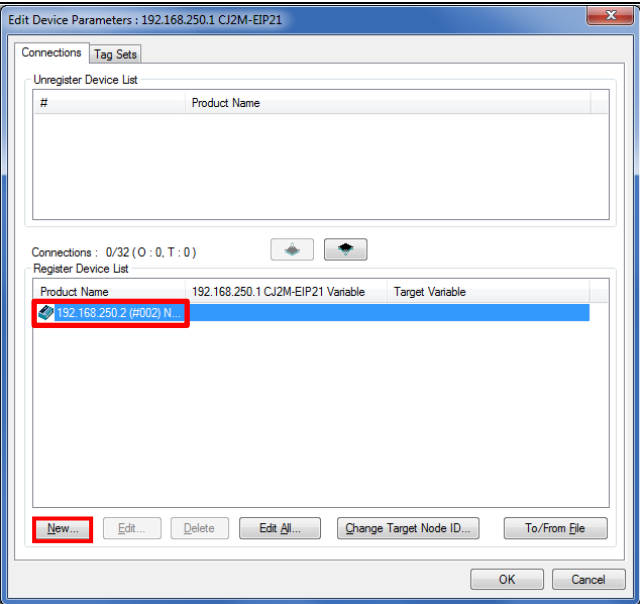
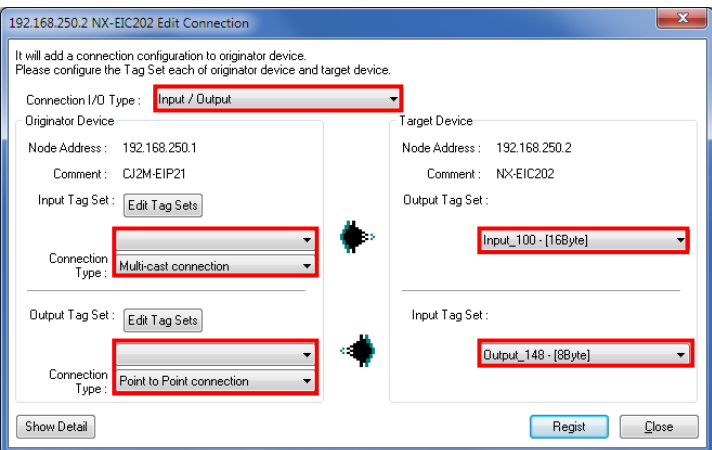
<p>1 Select <i>192.168.250.2</i> in the <i>Unregister Device List</i> Field. Click the Down Arrow Button that is shown in the dialog box.</p>	
<p>2 <i>192.168.250.2</i> is registered in the <i>Register Device List</i> Field. Select <i>192.168.250.2</i> and click New.</p>	
<p>3 The Edit Connection Dialog Box is displayed. Select Input / Output from the pull-down list of Connection I/O Type. Set the values listed in the following table in the <i>Originator Device</i> and the <i>Target Device</i> Fields.</p>	

■ Connection configuration settings

Connection configuration		Set value
Connection I/O Type		Input / Output
Originator Device	Input Tag Set	D10100-[16 Byte]
	Connection Type	Multi-cast connection
	Output Tag Set	D10000-[8 Byte]
Target Device	Connection Type	Point to Point connection
	Output Tag Set	Input_100-[16 Byte]
	Input Tag Set	Output_148- [8 Byte]

- 4 Check that the settings are correct. Click **Regist**.

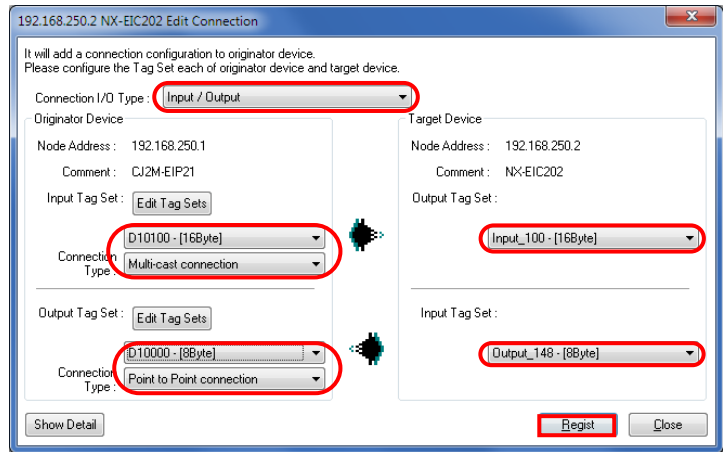

- 5 The Edit Connection Dialog Box is displayed again. Click **Close**.



- 6 The Edit Device Parameters Dialog Box is displayed again. Click **OK**.

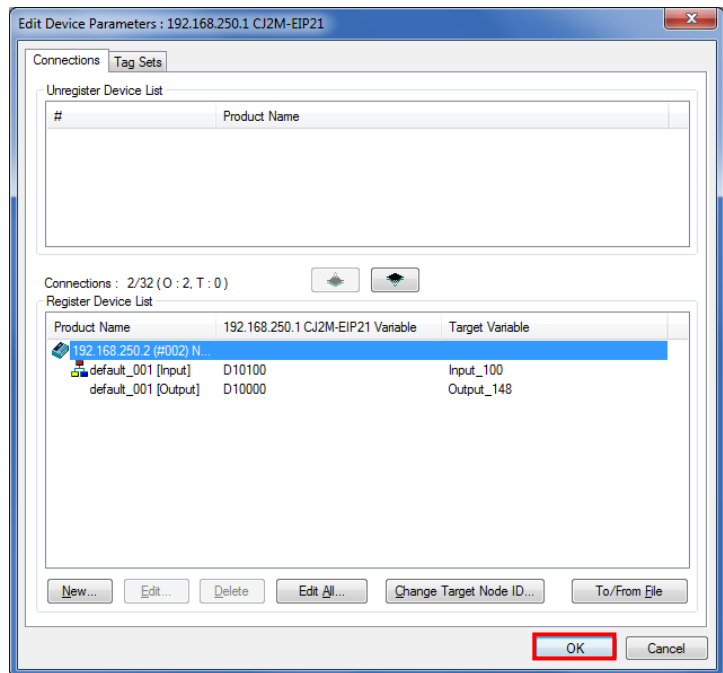

- 7 When the connection is completed, the registered node address is displayed under the device icon of node 2 in the Network Configuration Pane.

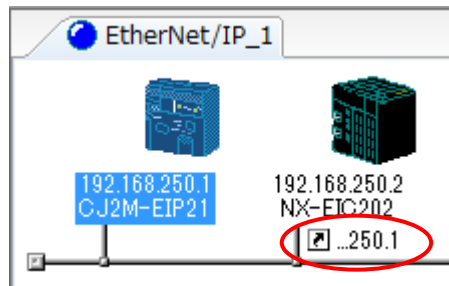

7.4.5. Transferring the Tag Data Link Parameters

Transfer the set tag data link parameters to PLC.

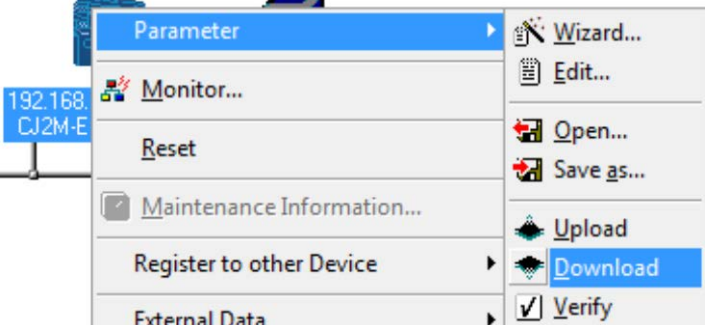
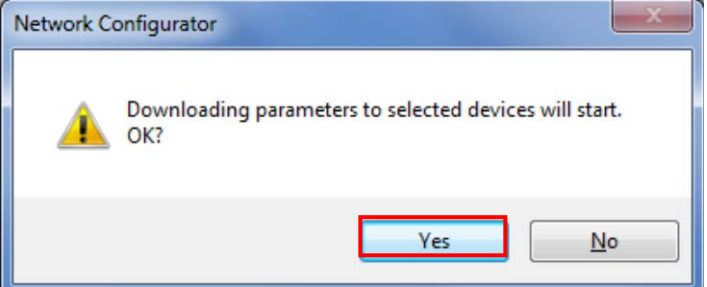
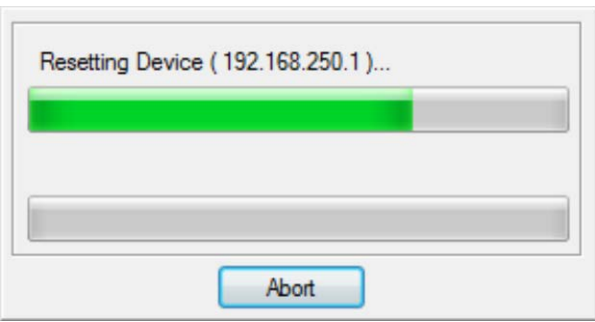
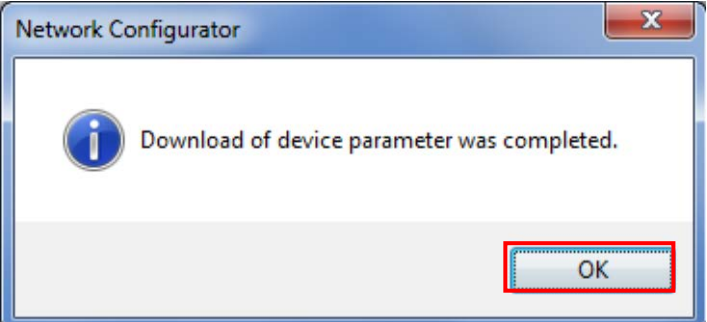
<p>1 Right-click the device icon of node 1 in the Network Configuration Pane and select Parameter - Download from the menu.</p>	
<p>2 The dialog box on the right is displayed. Confirm that there is no problem, and click Yes.</p>	
<p>3 The tag data link parameters are downloaded from Network Configurator to PLC.</p>	
<p>4 The dialog box on the right is displayed. Check the contents and click OK.</p>	

7.5. IO-Link Communication Status Check

Confirm that cyclic communications in the IO-Link system performs normally.

7.5.1. Checking the Connection Status

Check the connection status of each device.

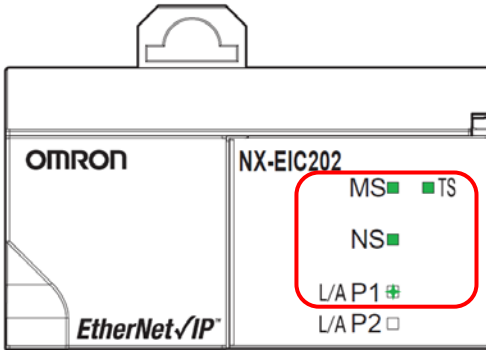
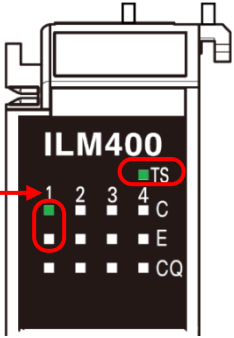
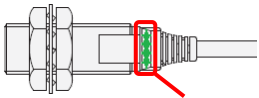
1	Turn ON I/O power supply for Slave Terminal.	
2	<p>Check with LED indicators on PLC (EtherNet/IP Unit) that the EtherNet/IP tag data links operate normally.</p> <p>The LED indicators in normal status are as follows:</p> <ul style="list-style-type: none"> MS: Green lit NS: Green lit COMM: Yellow lit 100M or 10M: Yellow lit 	
3	<p>Check the LED indicators on EtherNet/IP Coupler Unit.</p> <p>The LED indicators in normal status are as follows:</p> <ul style="list-style-type: none"> TS: Green lit MS: Green lit NS: Green lit L/A P1: Green flickering 	
4	<p>Check the LED indicators on IO-Link Master Unit.</p> <p>The LED indicators in normal status are as follows:</p> <ul style="list-style-type: none"> TS: Green lit Port 1-C: Green lit Port 1-E: Not lit 	
5	<p>Check the LED indicator on Proximity Sensor.</p> <p>The LED indicator in normal status is as follows:</p> <ul style="list-style-type: none"> Stability indicator / Communication indicator: Green blinking (1 sec Cycle) 	 <p>Stability indicator / Communication indicator (Green)</p>

- 6 The normal operation of tag data links is confirmed through the status information in the Monitor Device Dialog Box of Network Configurator.

Right-click the device icon of node 1 in the Network Configuration Pane and select **Monitor**.

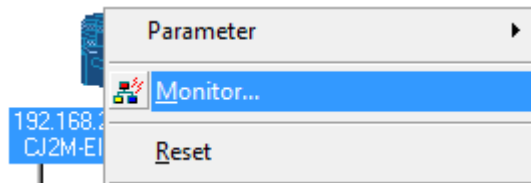

- 7 The dialog box on the right displays the Status 1 Tab Page in the Monitor Device Dialog Box.

When the same check boxes are selected as shown on the right, the tag data links are normally in operation.

Click **Close**.

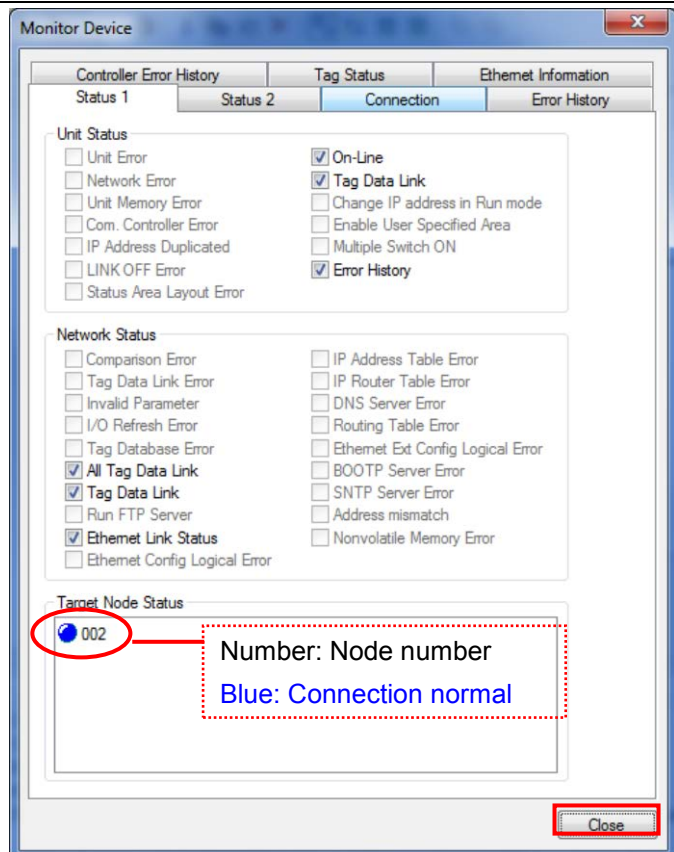

- 8 Select **Disconnect** from the Network Menu to go offline.

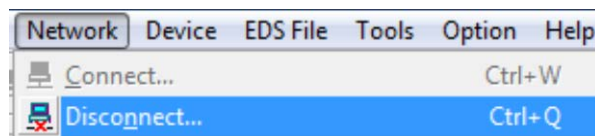

- 9 The color of the icon changes from blue to gray as shown on the right.

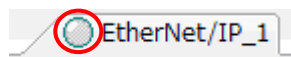

10 Select **Exit** from the File Menu to close Network Configurator.

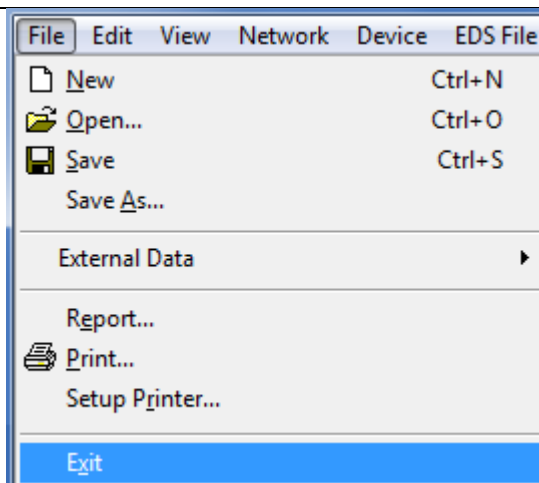

A confirmation dialog box is displayed whether or not you save the changed network configuration. Click **No**.

**If desired, save the changed network configuration.

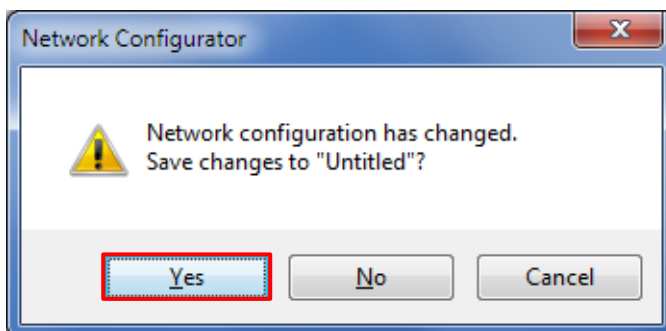

7.5.2. Checking the Receive Data

Check that the correct data are received.

Check that CX-ConfiguratorFDT is being installed on Personal computer.

CX-ConfiguratorFDT is included in Sysmac Studio.

 **Caution**

If you wire the I/O in the state where the devices are powered ON, doing so may cause damage to the devices.

Always read and follow the information provided in all safety precautions in the manuals for each device to be wired.



 **Caution**

If the PLC memory is changed by malfunction during monitoring power flow and present value status in the Ladder Section Window or in the Watch Window, the devices connected to output units may malfunction, regardless of the operating mode of CPU Unit.

Always ensure safety before monitoring power flow and present value status in the Ladder Section Window or in the Watch Window.



- 1 Check that the operating mode of PLC is Stop/Program Mode.

*If PLC is not in Stop/Program Mode, change to Stop/Program Mode by referring to *step 1 of 7.3.3. Creating the I/O Table and setting the IP Address.*

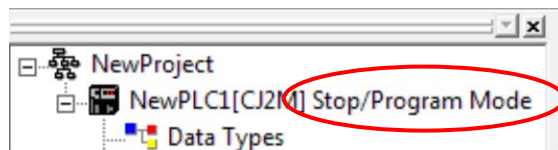

- 2 Select **Edit - Memory** from the PLC Menu.

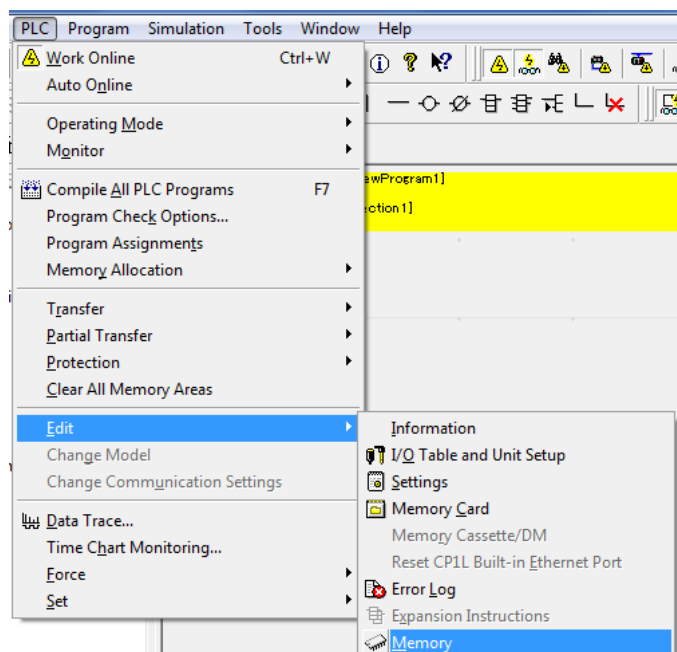

3 The PLC Memory Window is displayed. Double-click **D** on the *Memory Tab* of the PLC Memory Window.

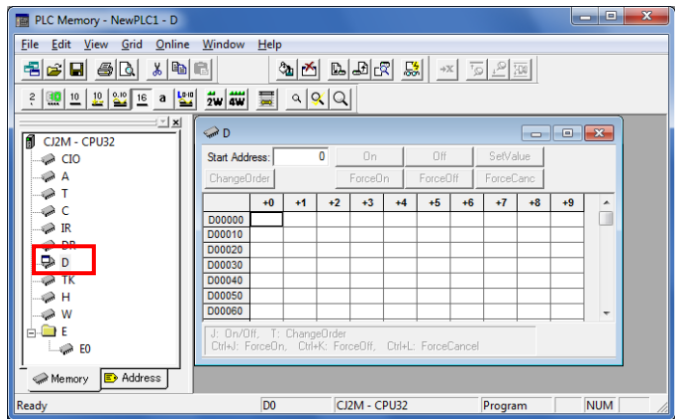

4 Select **Display - Hexadecimal** from the View Menu.

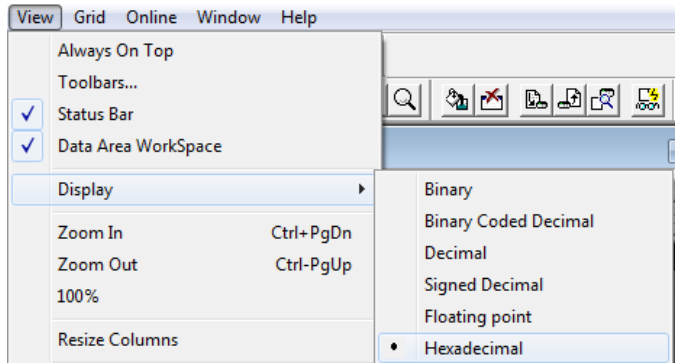

5 Select **Monitor** from the Online Menu.

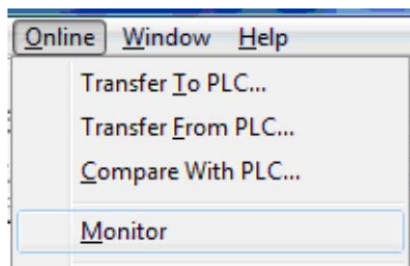

6 The Monitor Memory Areas Dialog Box is displayed. Check that **D** is selected. Click **Monitor**.

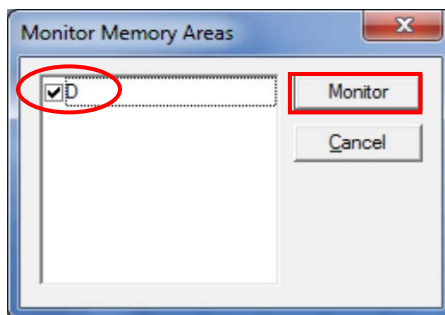

7 Enter **10100** in the *Start Address* Field of the D Window.

Check that the start address changes to D10100.

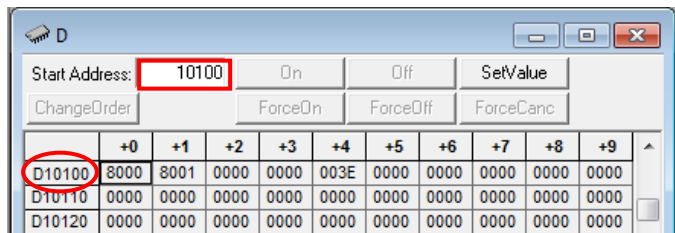

8 Start CX-ConfiguratorFDT.

*Click **Yes** if a dialog box to update the device catalog is displayed when starting CX-ConfiguratorFDT.

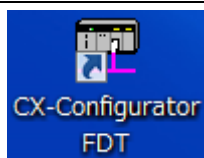

- 9 CX-ConfiguratorFDT starts.
Right-click **MyNetwork** in the Network View and select **Add** from the menu.

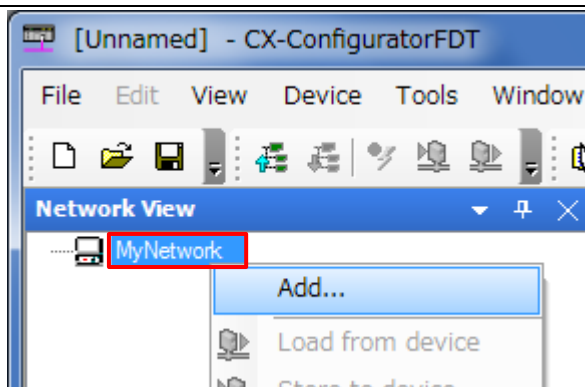

- 10 The Add Dialog Box is displayed.
Select *NX Coupler USB*.
Click **OK**.

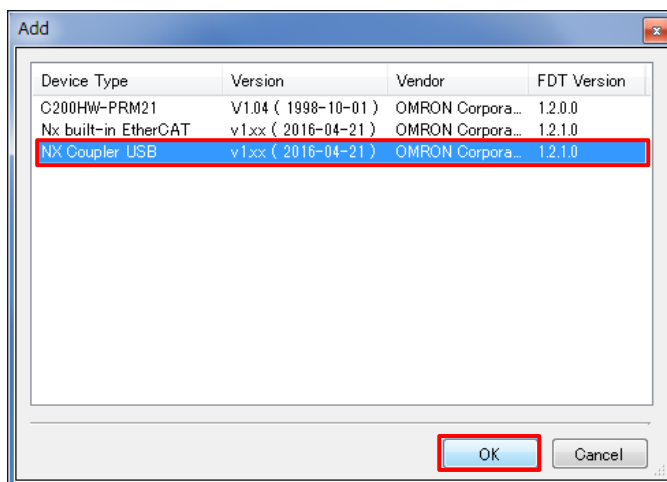

- 11 Check that <NX bus> NX Coupler USB is added under MyNetwork in the Network View.

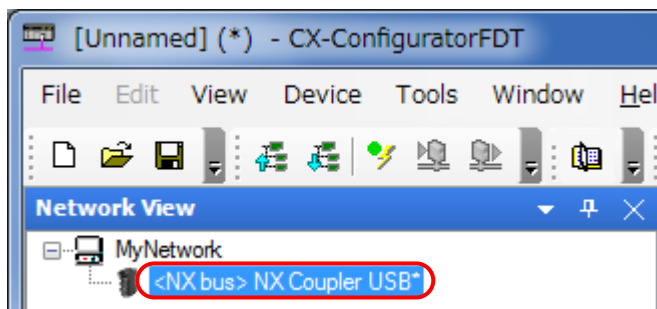

12 Right-click <NX bus> NX Coupler USB and select **Scan - Create Network** from the menu.

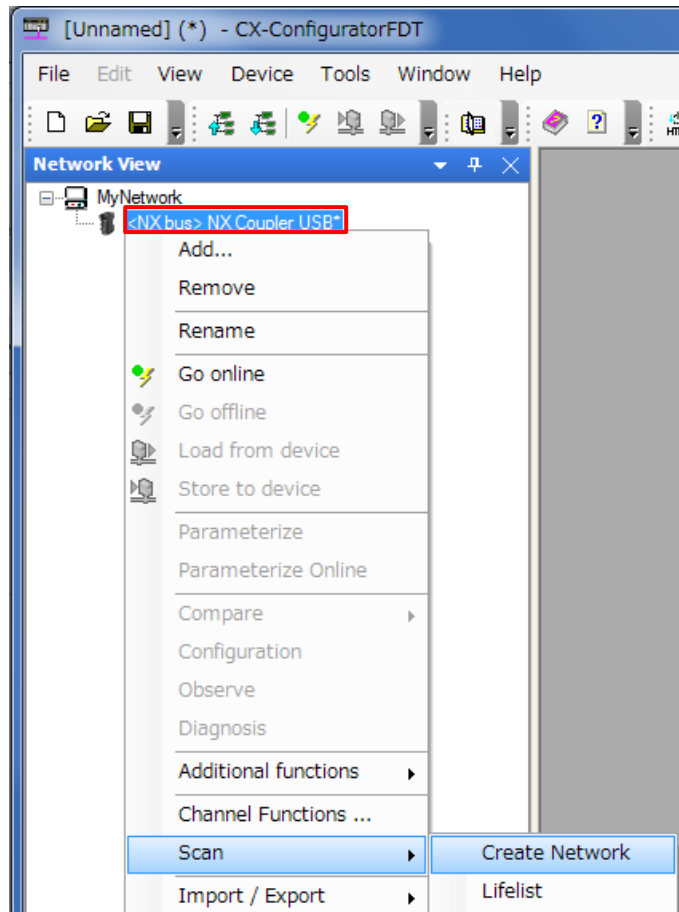

13 The Lifelist Dialog Box is displayed after completing the network scan. Check that <IO-Link Port_1:NOT_APPLICABLE> E2E-X3B4-IL3 IODD1.1 is added under NX-ILM400. Click **Add All and Continue**.

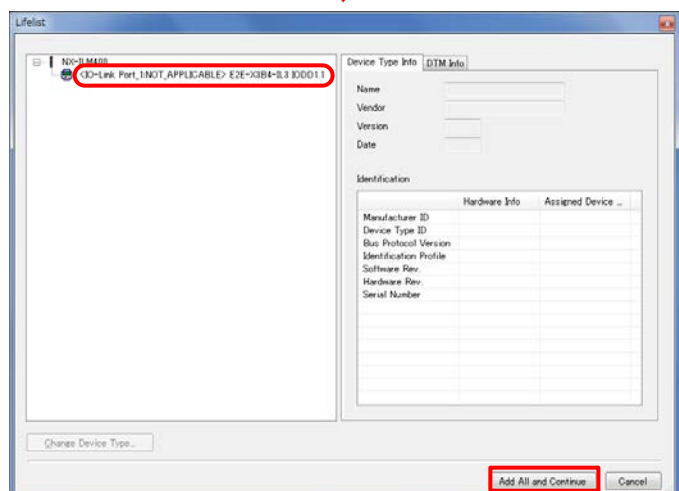
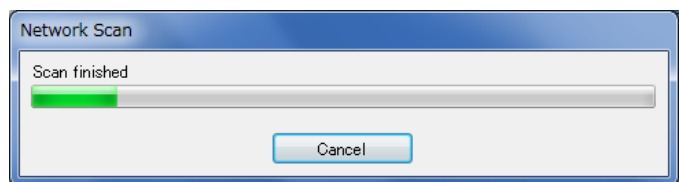

14 Check that the network configuration is created in the Network View as shown on the right.

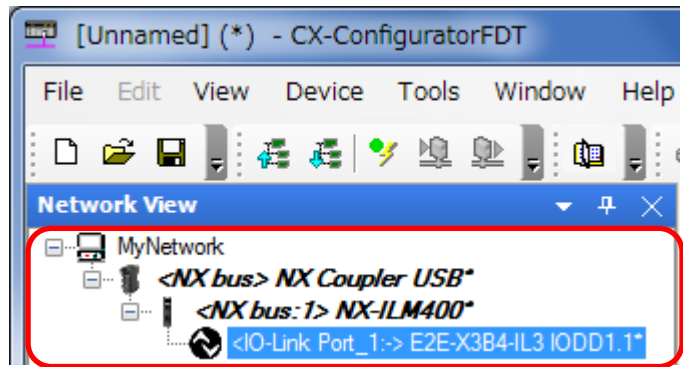

15 Right-click <IO-Link Port_ 1-> E2E-X3B4-IL3 IODD1.1 and select **Go online** from the menu.

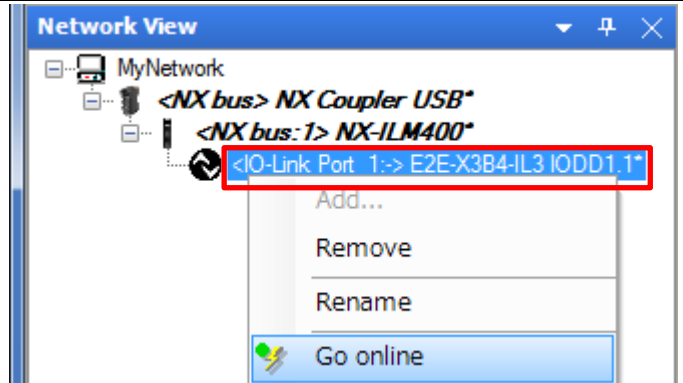

16 Check that Proximity Sensor is connected online. Right-click <IO-Link Port_ 1-> E2E-X3B4-IL3 IODD1.1 and select **Configuration** from the menu.

*When <IO-Link Port_ 1-> E2E-X3B4-IL3 IODD1.1 is displayed in bold italic font, Proximity Sensor is connected online.

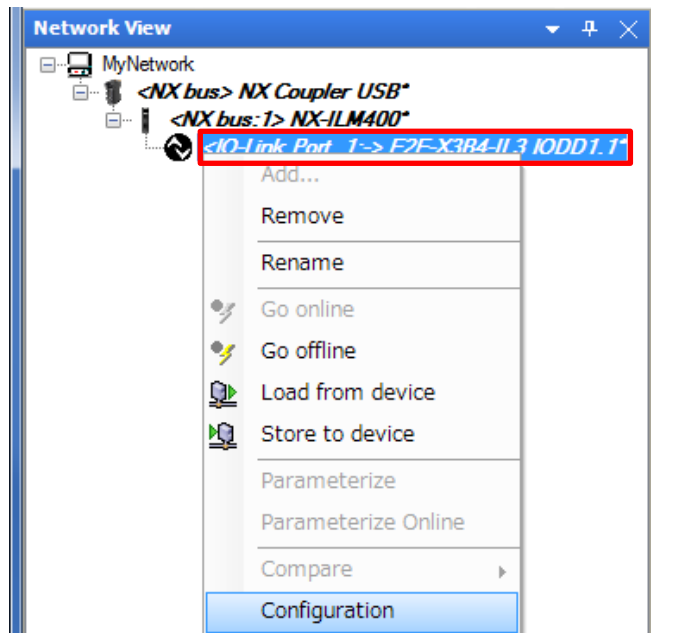

17 The <IO-Link Port_ 1-> E2E-X3B4-IL3 IODD1.1 - Configuration Tab Page is displayed.

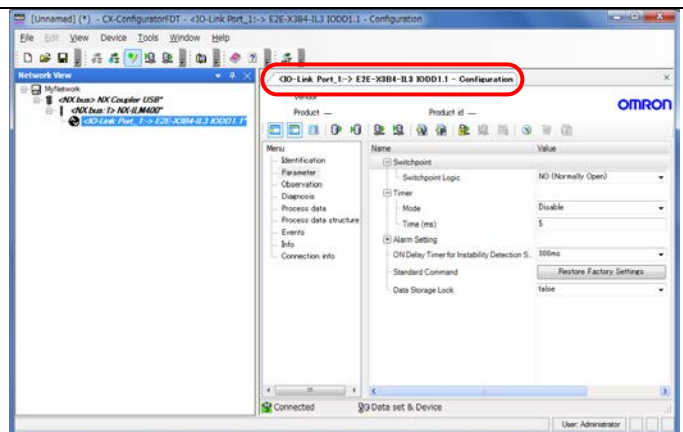

18 Select **Observation** listed under Menu on the <IO-Link Port_1:-> E2E-X3B4-IL3 IODD1.1 - Configuration Tab Page. If Process Data In on the right side of the tab page is not expanded, click the + Button of Process Data In to expand.

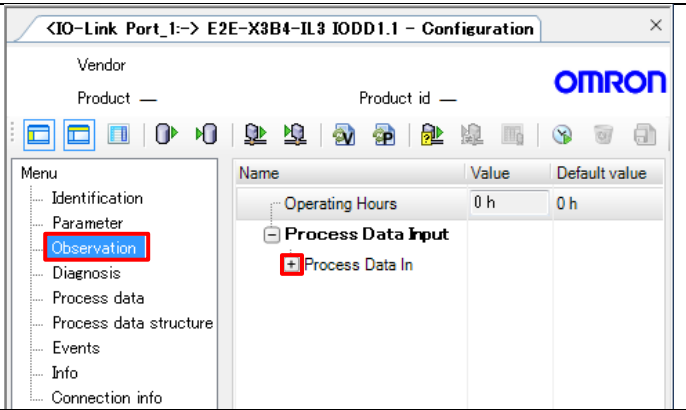

19 Click the  icon (Enable or disable cyclic read from device for dynamic variables) on the <IO-Link Port_1:-> E2E-X3B4-IL3 IODD1.1 - Configuration Tab Page. The present values of the process data for Proximity Sensor are displayed in the Value Column.

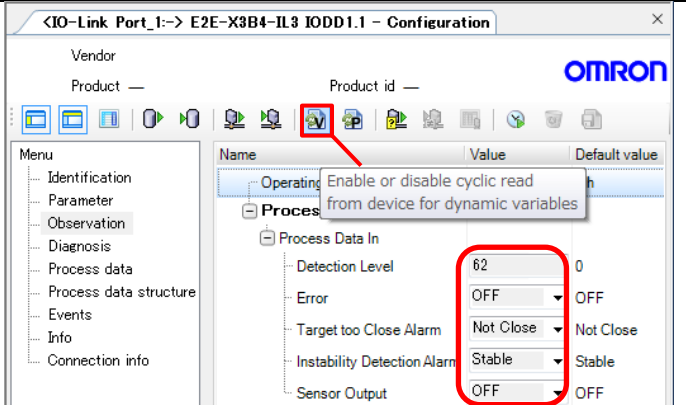

20 Make sure that there is no sensing object in front of Proximity Sensor and that Operation indicator is not lit.

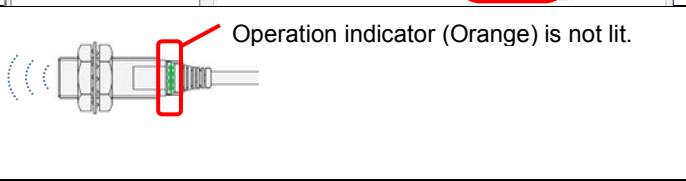

21 Check that the values of Proximity Sensor in CX-ConfiguratorFDT are as shown below.

Detection Level: 62
Sensor Output: OFF

*The value of the detection level differs depending on the environmental settings of Proximity Sensor.

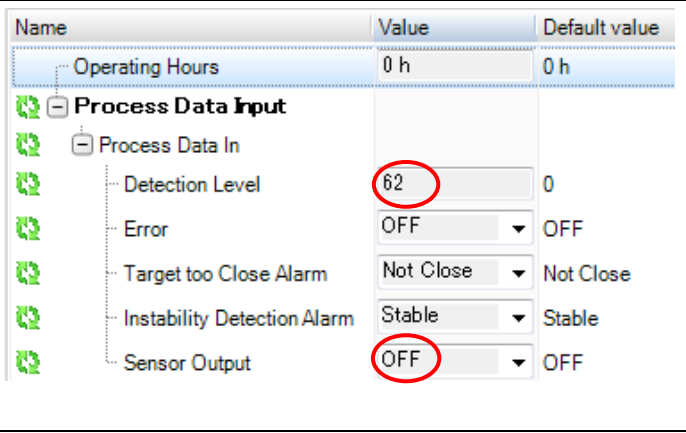

22 In the PLC Memory Window of CX-Programmer, check that the value of D10104 is as shown below.

D10104

Bits 0 to 7: 62 (dec)

Bits 8 : 0 (bin)

	+0	+1	+2	+3	+4	+5	+6	+7	+8	+9
D10100	8000	8001	0000	0000	003E	0000	0000	0000	0000	0000
D10110	0000	0000	0000	0000	0000	0000	0000	0000	0000	0000
D10120	0000	0000	0000	0000	0000	0000	0000	0000	0000	0000

D10104

Bits 0 to 7 : 3E (hex) → 62 (dec)

Bits 8 to 15: 00 (hex) → 00000000 (bin)

(Check that the bit 8 is 0.)

*For details on each of the addresses, refer to 6.4. Tag Data Link Settings.

*You can check that the monitor output (Detection Level) of Port 1 is 62 and that the control output (Sensor Output) is OFF; these values are the same as the ones described in step 21.

23 Place Sensing object in front of Proximity Sensor and check that Operation indicator is lit in orange.

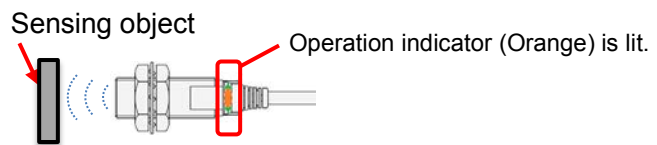

24 Check that the values of Proximity Sensor in CX-ConfiguratorFDT are as shown below.

Detection Level: 133

Sensor Output : ON

Name	Value	Default value
Operating Hours	0 h	0 h
Process Data Input		
Process Data In		
Detection Level	133	0
Error	OFF	OFF
Target too Close Alarm	Not Close	Not Close
Instability Detection Alarm	Stable	Stable
Sensor Output	ON	OFF

*The value of the detection level differs depending on the environmental settings of Proximity Sensor.

25 In the PLC Memory Window of CX-Programmer, check that the value of D10104 is as shown below.

D10104

Bits 0 to 7: 85 (dec)

Bits 8 : 1 (bin)

	+0	+1	+2	+3	+4	+5	+6	+7	+8	+9
D10100	8000	8001	0000	0000	0185	0000	0000	0000	0000	0000
D10110	0000	0000	0000	0000	0000	0000	0000	0000	0000	0000
D10120	0000	0000	0000	0000	0000	0000	0000	0000	0000	0000

D10104

Bits 0 to 7 : 85 (hex) → 133 (dec)

Bits 8 to 15: 01 (hex) → 00000001 (bin)

(Check that the bit 8 is 1.)

*For details on each of the addresses, refer to 6.4. Tag Data Link Settings.

*You can check that the monitor output (Detection Level) of Port 1 is 133 and that the control output (Sensor Output) is ON; these values are the same as the ones described in step 24.

8. Initialization Method

The setting procedures in this document are based on the factory default settings. Some settings may not be applicable unless you use the devices with the factory default settings.

8.1. Initializing PLC

To initialize the PLC settings, it is necessary to initialize EtherNet/IP Unit and CPU Unit. Change the operating mode of PLC to PROGRAM mode before the initialization.

8.1.1. EtherNet/IP Unit

To initialize the EtherNet/IP Unit settings, select **Edit - I/O Table and Unit Setup** from the PLC Menu in CX-Programmer, and follow the steps below.

(1) Right-click EtherNet/IP Unit in the PLC IO Table Window and select **Unit Setup** from the menu.

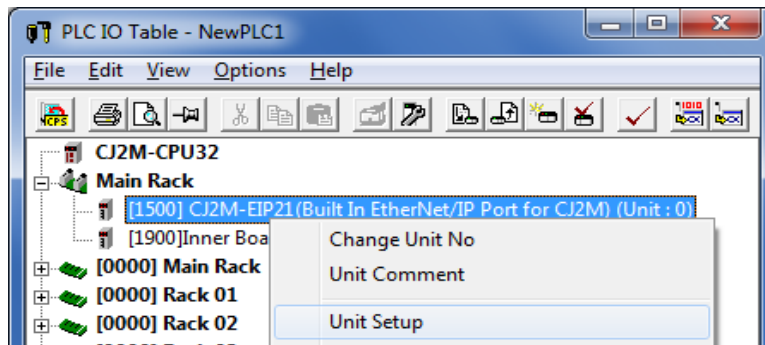

(2) Click **Restart** in the Edit Parameters Dialog Box.

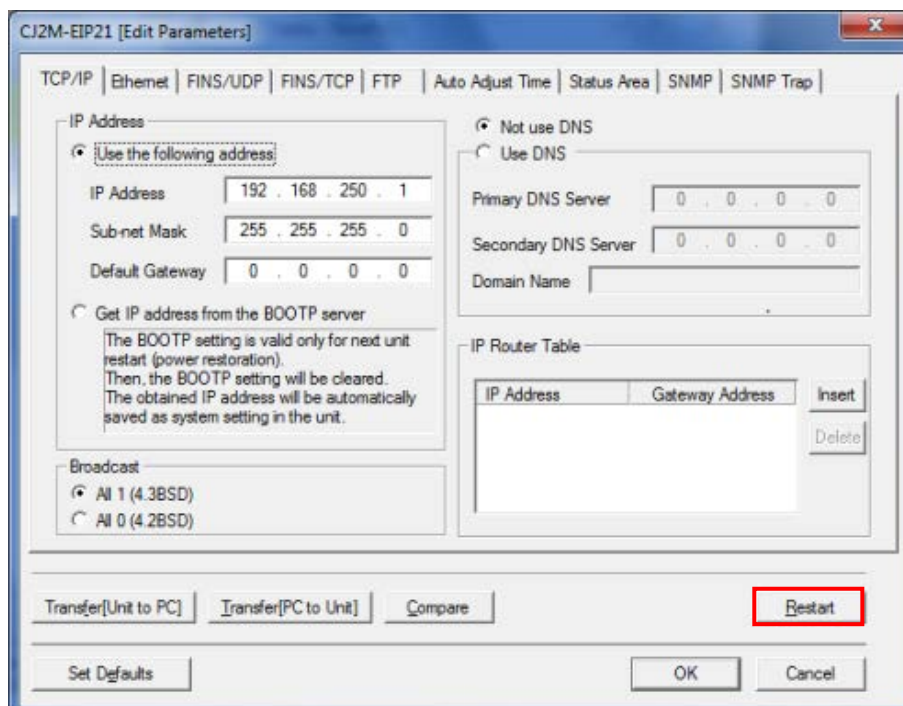

- (3) An execution confirmation dialog box is displayed. Confirm that there is no problem, and click **Yes**.
- (4) The Restart Unit Dialog Box is displayed. Select *Return to out-of-box configuration, and then emulate cycling power*, and click **OK**.

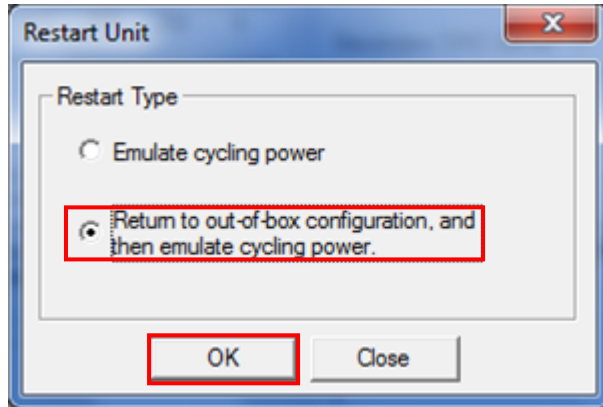

- (5) A dialog box is displayed indicating that the execution is completed. Check the contents and click **OK**.

8.1.2. CPU Unit

To initialize the CPU Unit settings, select **Clear All Memory Areas** from the PLC Menu in CX-Programmer. Select *Initialize* in the Confirm All Memory Area Clear Dialog Box and click **OK**.

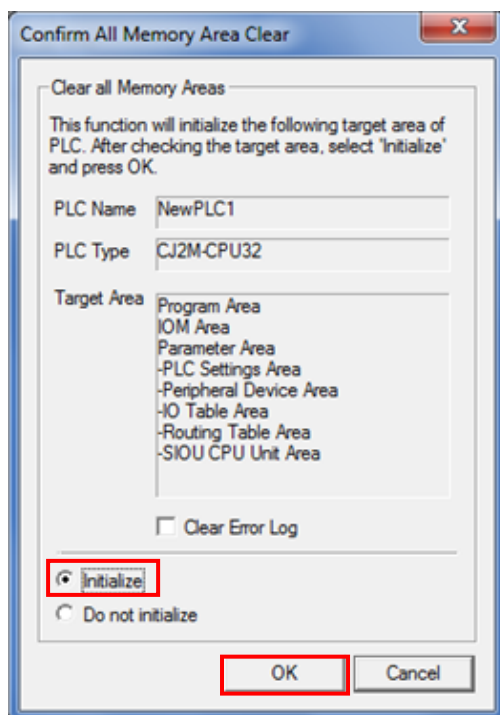

8.2. Initializing Slave Terminal

To initialize the Slave Terminal settings, connect Sysmac Studio online with Slave Terminal and take the following steps.

- (1) Right-click the device icon of EtherNet/IP Coupler Unit (Unit 0). Select **Clear All Memory** from the menu.

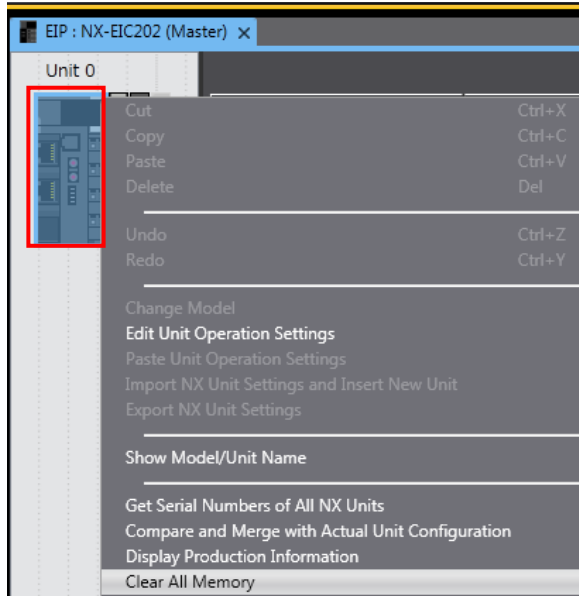

- (2) The Clear All Memory for Coupler Dialog Box is displayed. Check that Coupler + NX Units is selected. Click **Execute**.

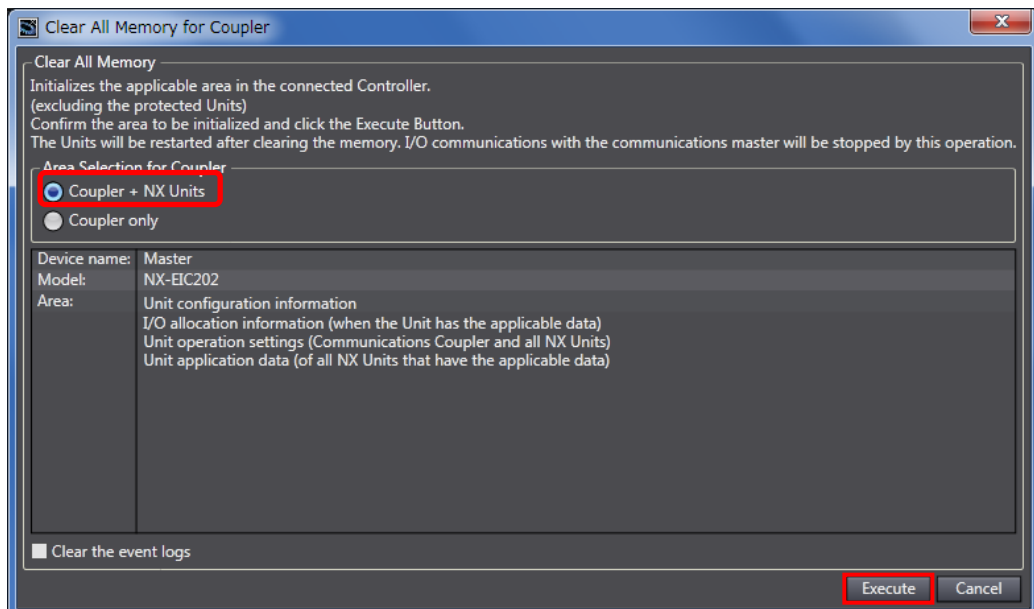

Precautions for Correct Use

In the initialization of Slave Terminal, the backup data for the IO-Link devices that is stored in IO-Link Master Unit is not cleared. If you need to clear the backup data stored in IO-Link Master Unit, refer to *Clearing Backup Data* in 7-4-2 Backing Up Settings of the *IO-Link System User's Manual* (Cat. No. W570) to clear the backup data.

8.3. Initialization of Proximity Sensor

To initialize Proximity Sensor, Execute System-Command to "Restore factory settings".
For details, refer to 4. *Service data* of the *PROXIMITY SENSOR INDEX LIST* (Cat. No. 9540292-0).

9. Revision History

Revision code	Date of revision	Description of revision
01	August 8, 2016	First edition

OMRON Corporation Industrial Automation Company

Tokyo, JAPAN

Contact: www.ia.omron.com

Regional Headquarters

OMRON EUROPE B.V.

Wegalaan 67-69, 2132 JD Hoofddorp
The Netherlands
Tel: (31)2356-81-300/Fax: (31)2356-81-388

OMRON ELECTRONICS LLC

2895 Greenspoint Parkway, Suite 200
Hoffman Estates, IL 60169 U.S.A
Tel: (1) 847-843-7900/Fax: (1) 847-843-7787

OMRON ASIA PACIFIC PTE. LTD.

No. 438A Alexandra Road # 05-05/08 (Lobby 2),
Alexandra Technopark,
Singapore 119967
Tel: (65) 6835-3011/Fax: (65) 6835-2711

OMRON (CHINA) CO., LTD.

Room 2211, Bank of China Tower,
200 Yin Cheng Zhong Road,
PuDong New Area, Shanghai, 200120, China
Tel: (86) 21-5037-2222/Fax: (86) 21-5037-2200

Authorized Distributor:

© OMRON Corporation 2016 All Rights Reserved.
In the interest of product improvement,
specifications are subject to change without notice.

Cat. No. P668-E1-01

0816(-)